

# Simple Plots

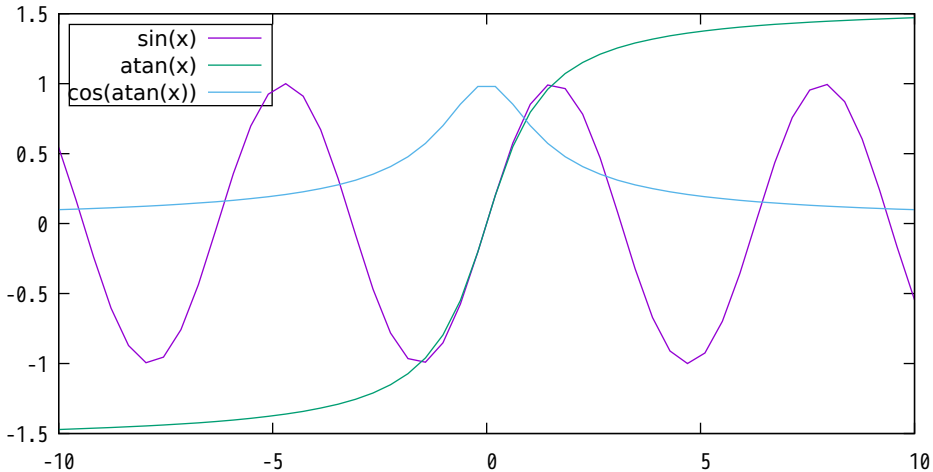

# Simple Plots

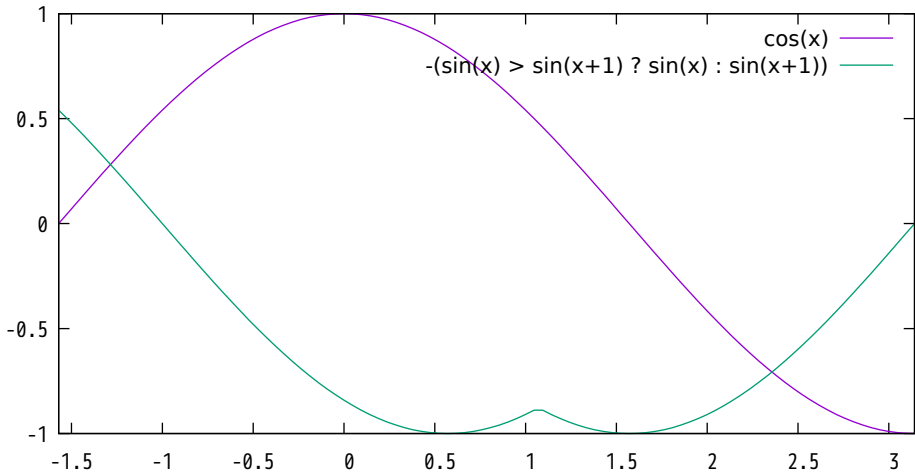

# Simple Plots

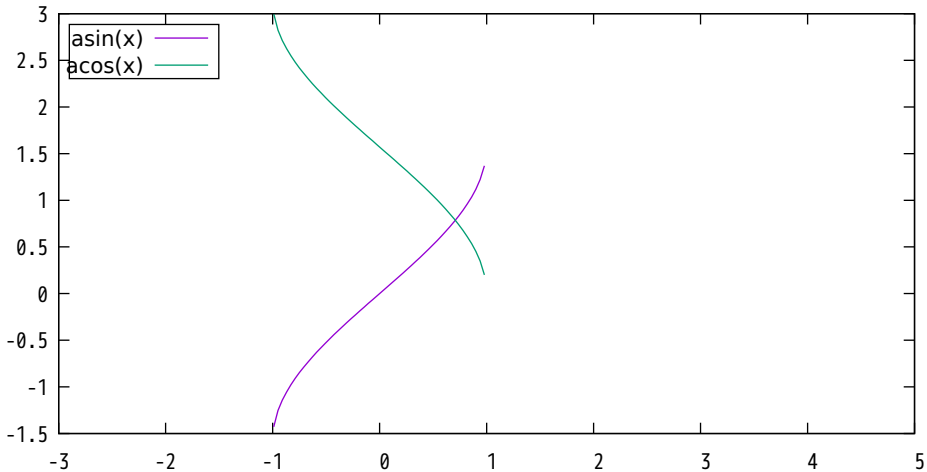

# Simple Plots

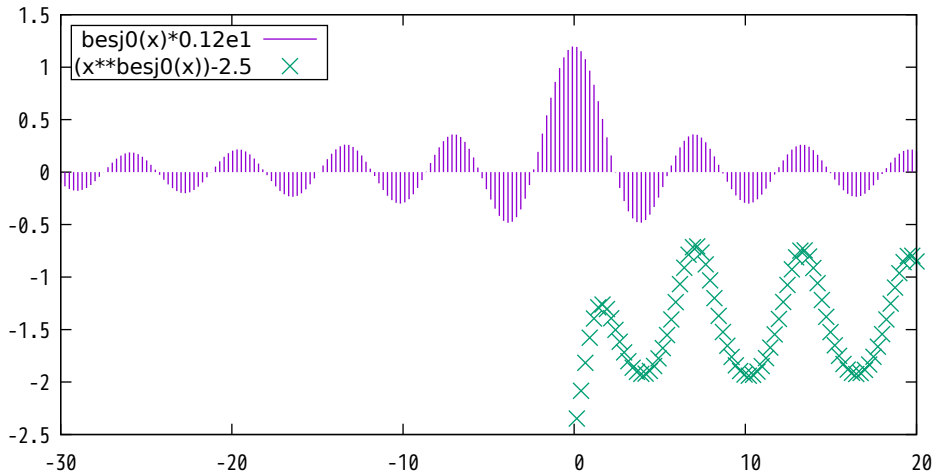

# Simple Plots

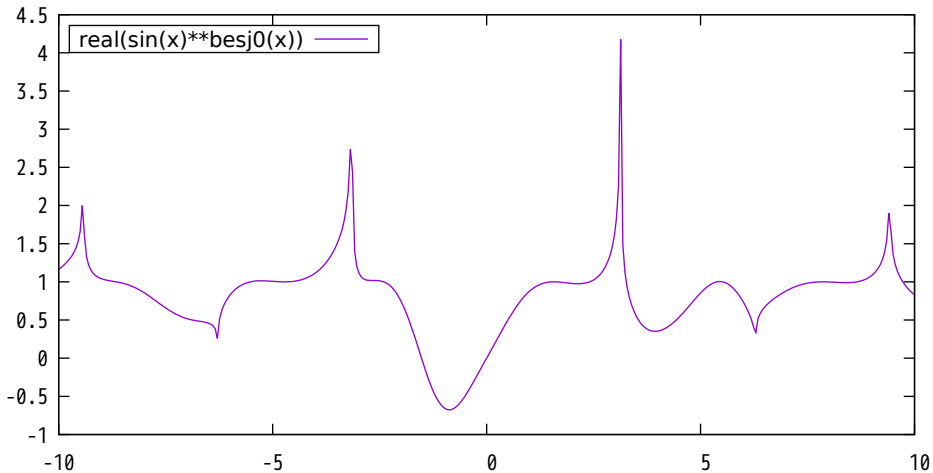

# Simple Plots

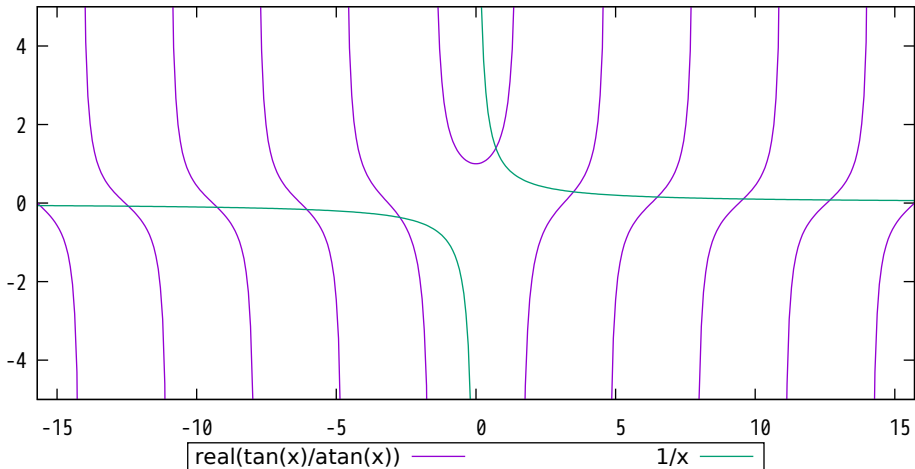

# Simple Plots

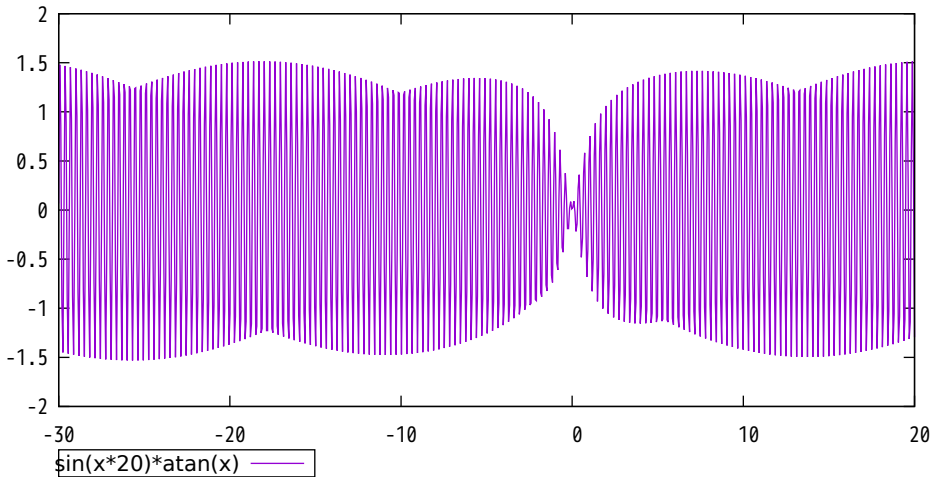

# Simple Plots

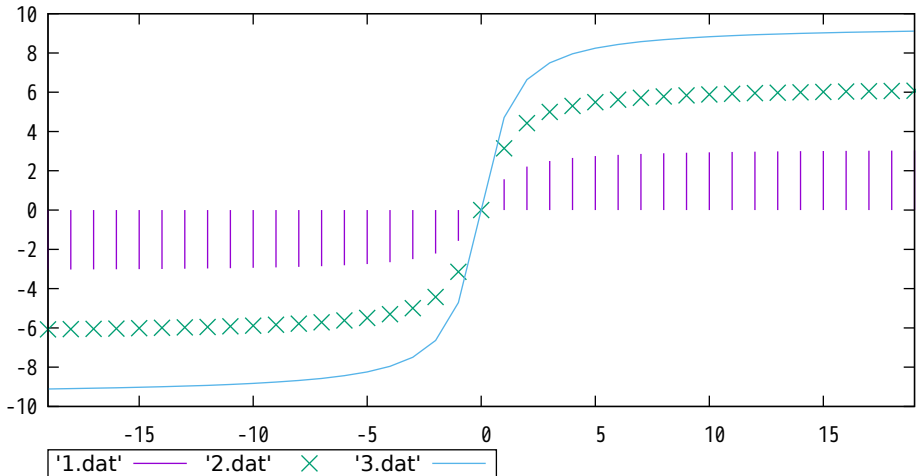



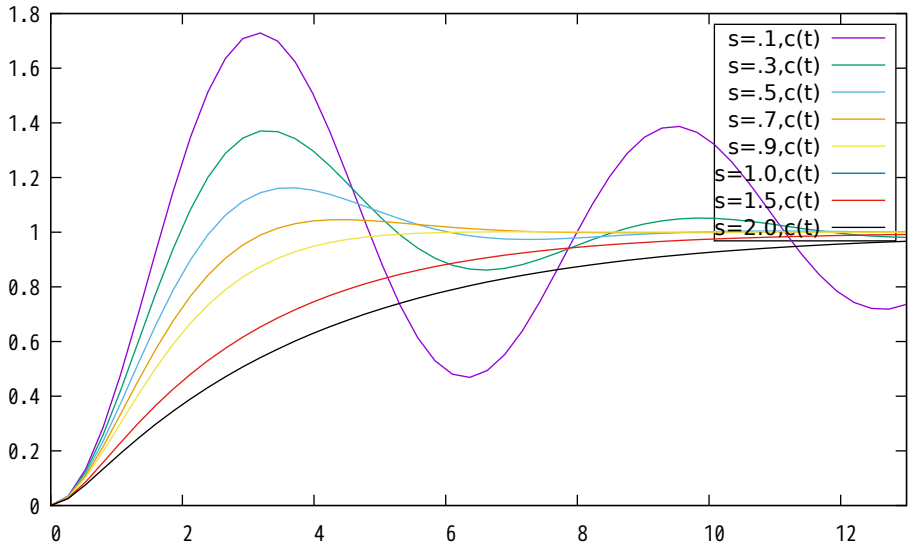

Mutual Characteristic of a Transistor

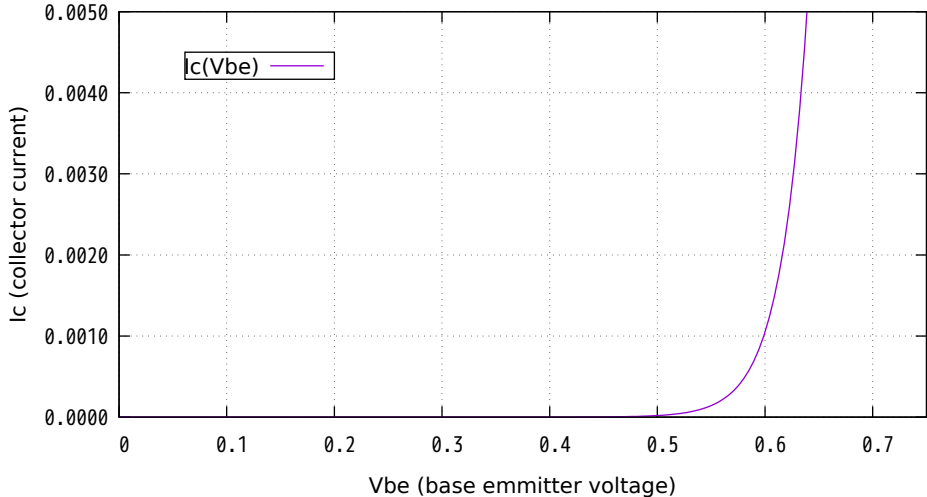

# JFET Mutual Characteristic

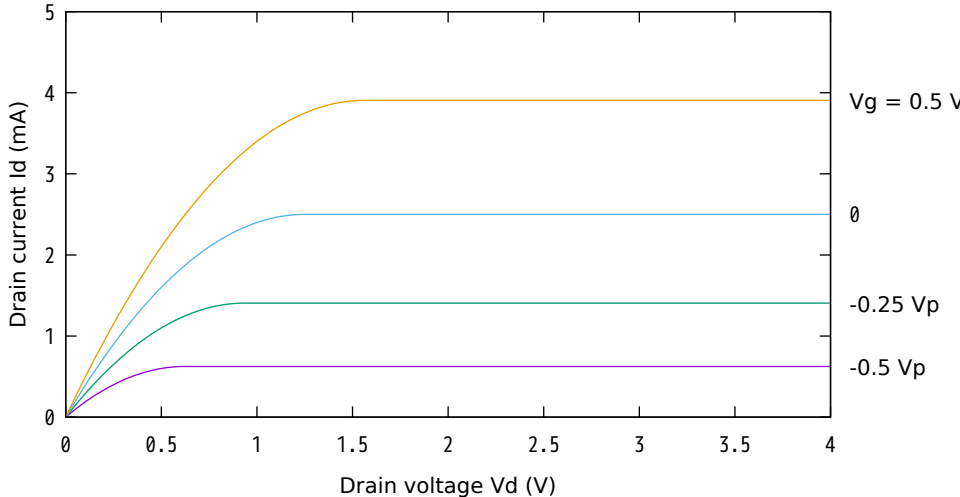

# Amplitude and Phase Frequency Response

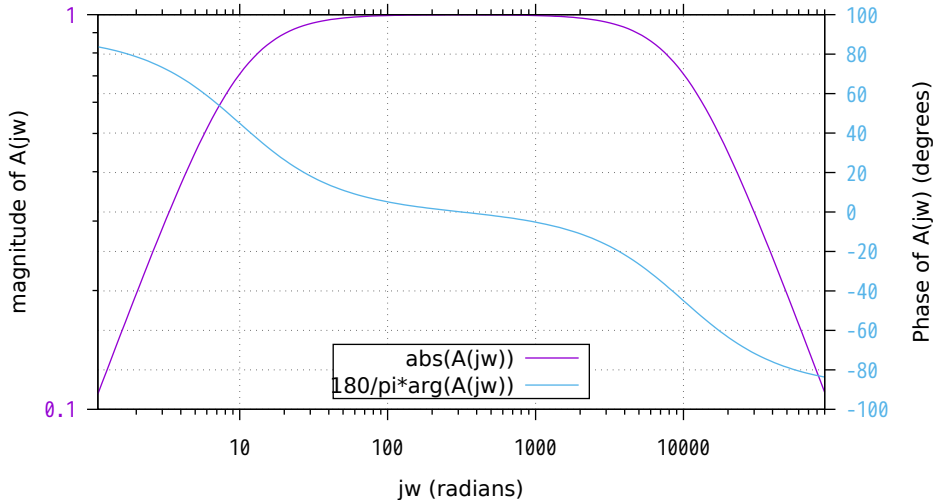

## Convex November 1-7 1989 Circadian

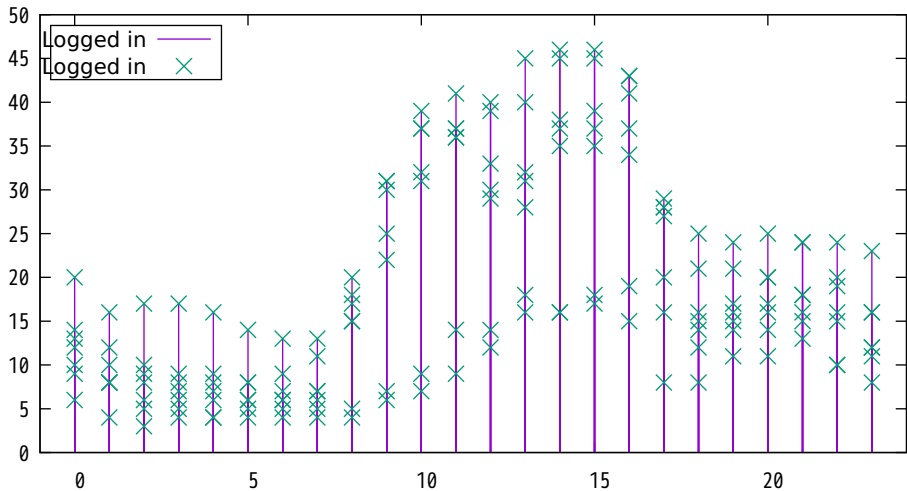

Convex November 1-7 1989

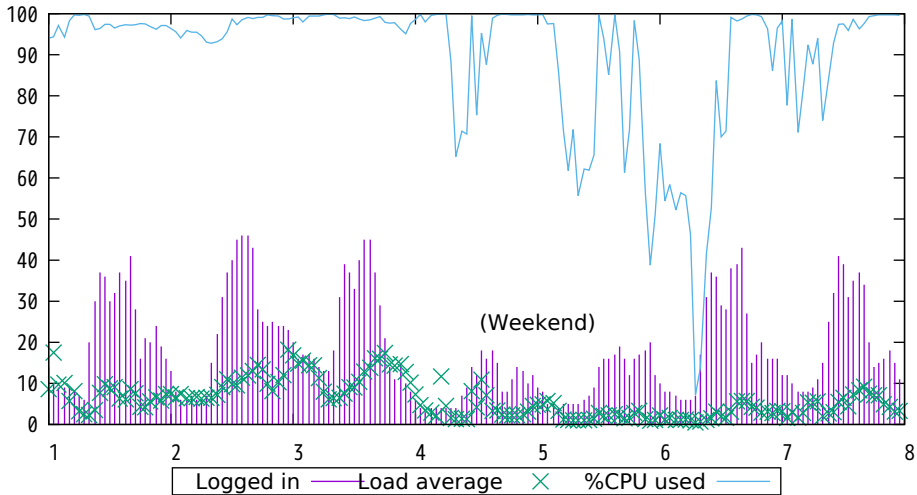

# A demonstration of boxes with default properties

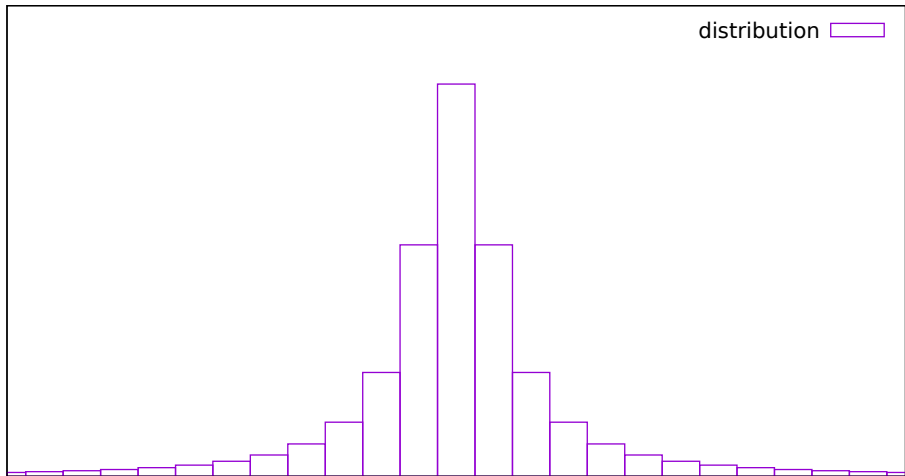

A demonstration of boxes with style fill solid 1.0

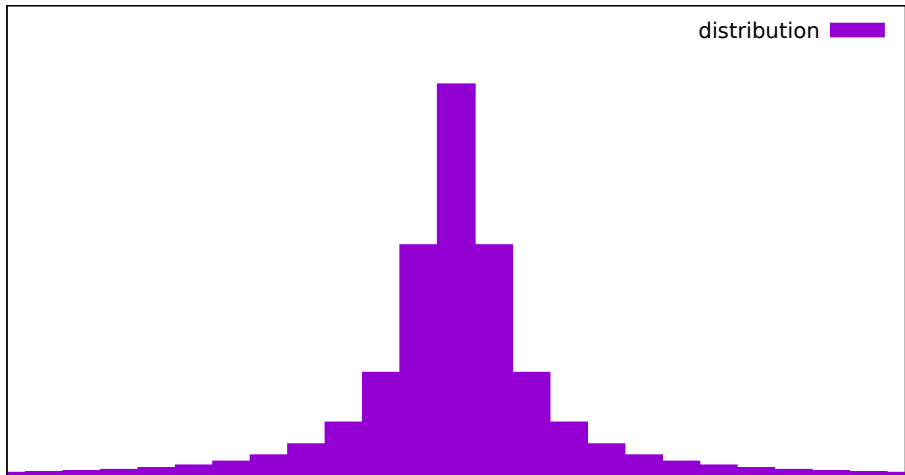



# A demonstration of boxes with style fill solid border -1

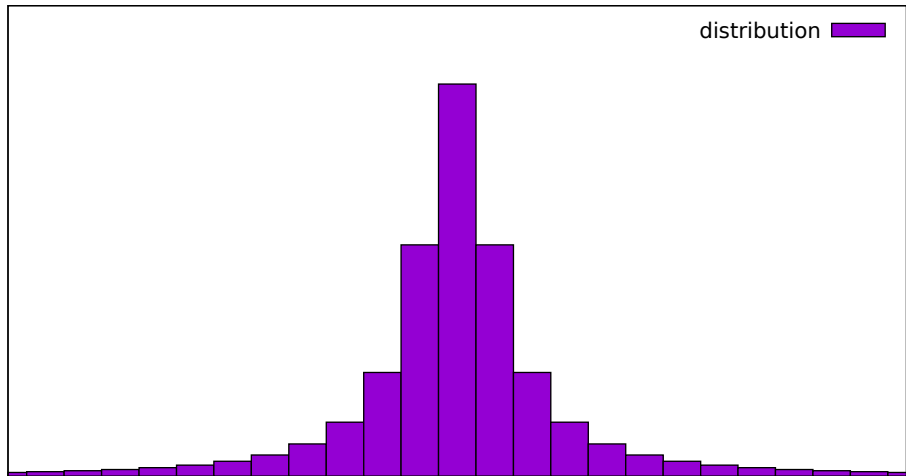

Filled boxes of reduced width

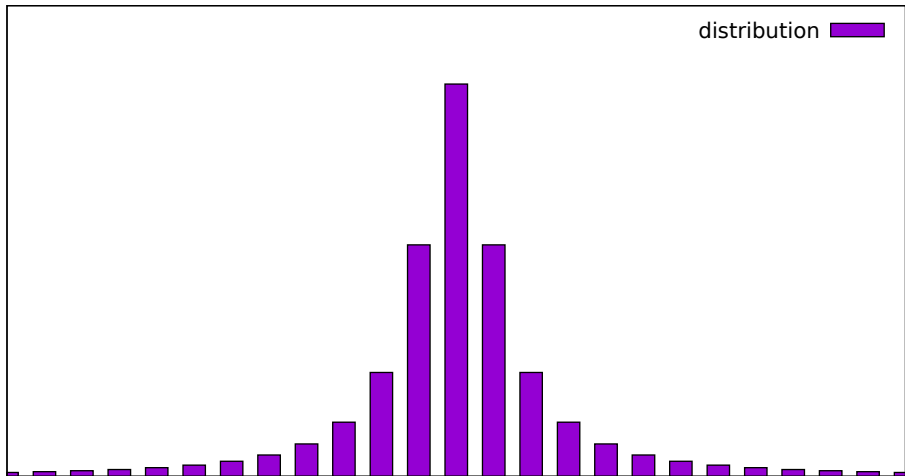

# Filled boxes at 50% fill density

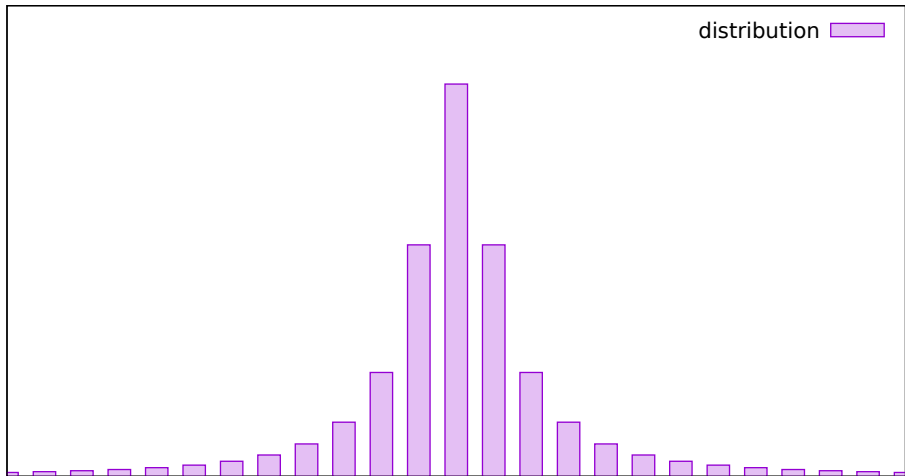

A demonstration of boxes with style fill solid 0.25 noborder

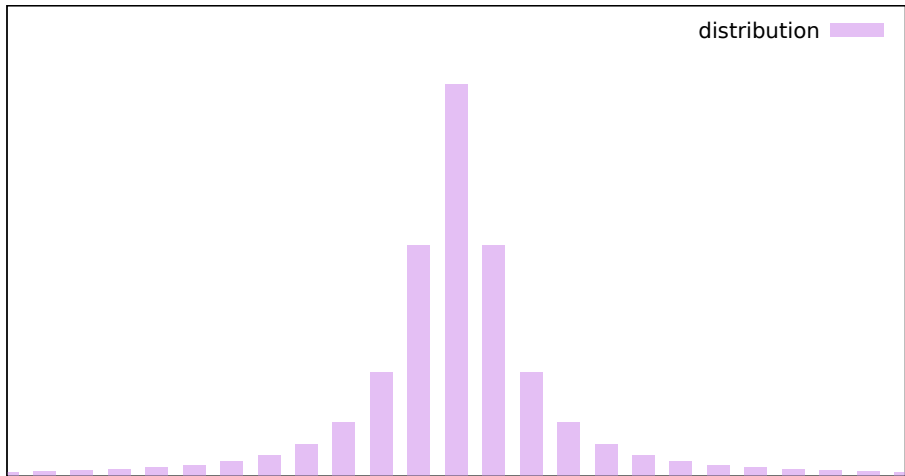



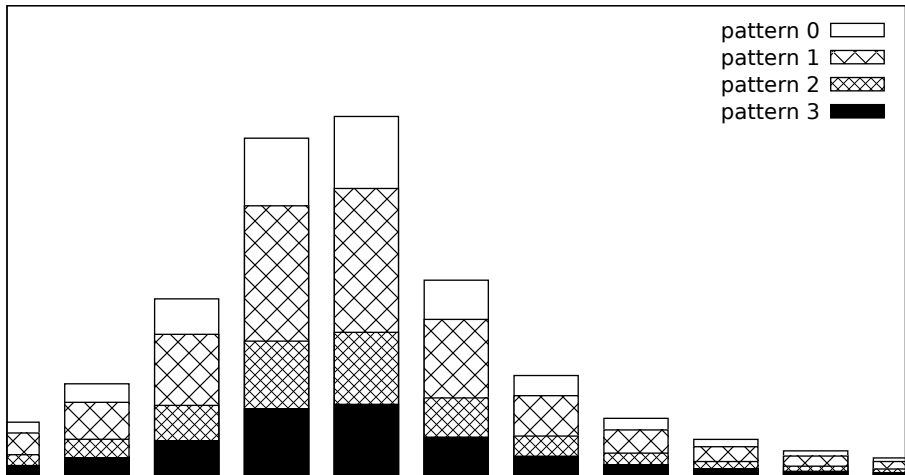

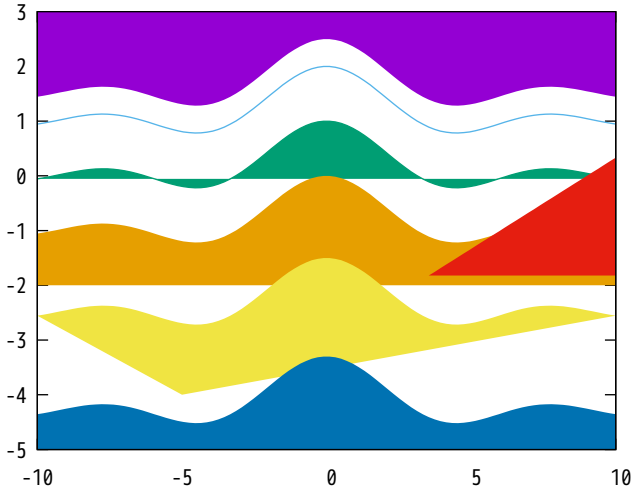

# A demonstration of boxes in mono with style fill pattern



plot with filledcurve [options]



- $1.5 + \sin(x)/x$  
- $\sin(x)/x$  
- $1 + \sin(x)/x$  
- $-1 + \sin(x)/x$  
- $-2.5 + \sin(x)/x$  
- $-4.3 + \sin(x)/x$  
- $(x > 3.5 ? x/3 - 3 : 1/0)$  

# Intersection of two parabolas

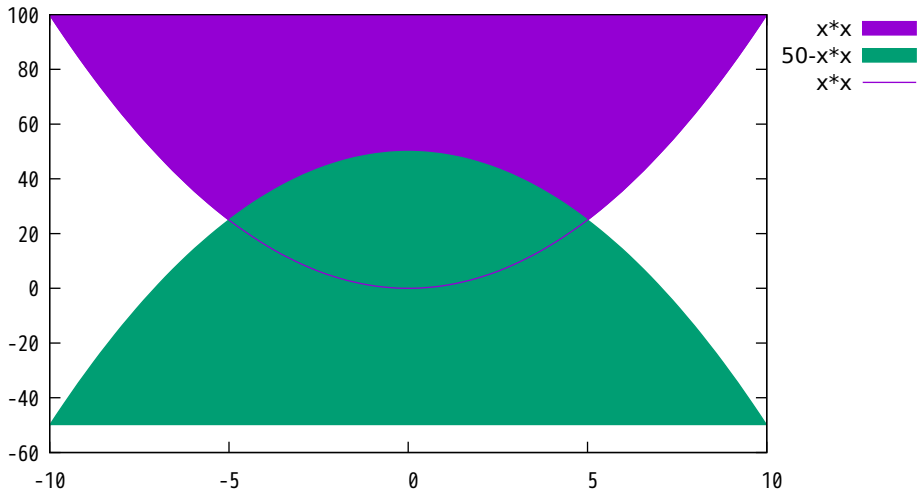

Filled sinus and cosinus curves

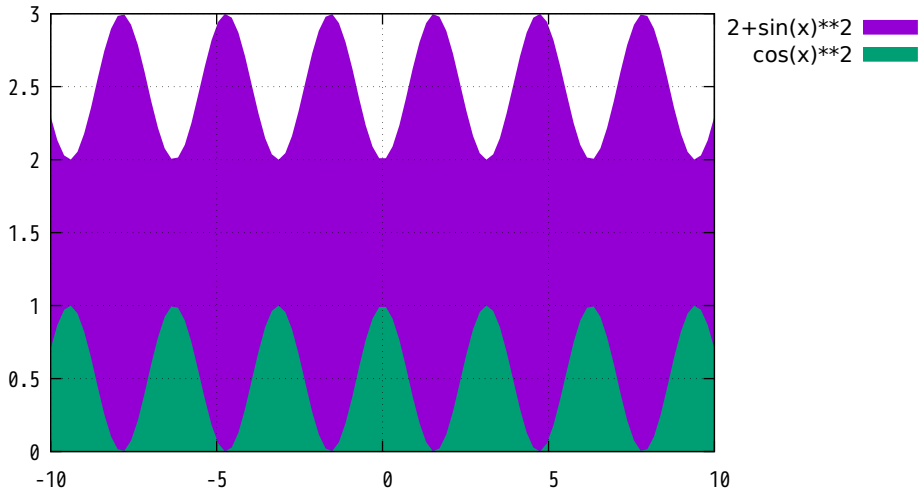



The red bat:  $\text{abs}(x)$  with filledcurve  $xy=2,5$

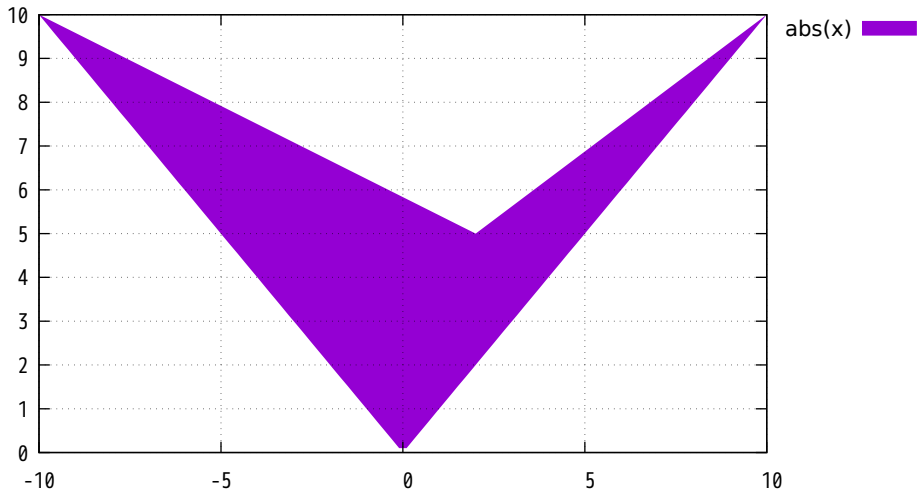

Some sqrt stripes on filled graph background

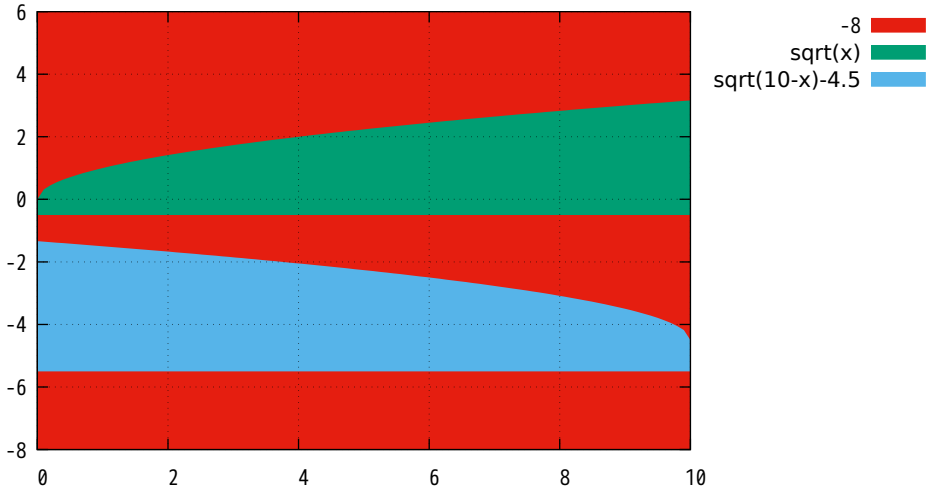

Let's smile with parametric filled curves

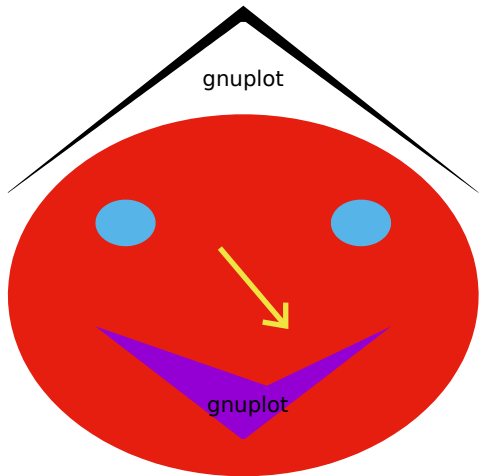

world.dat plotted with filledcurves

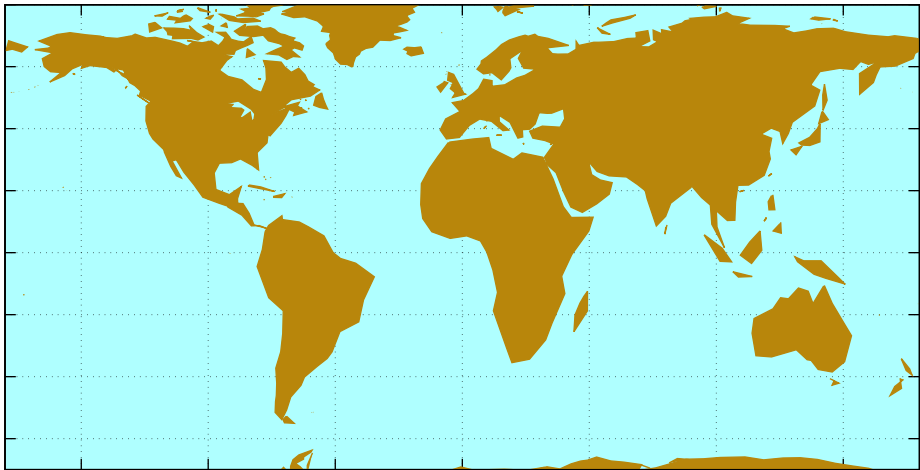

Fill area between two curves

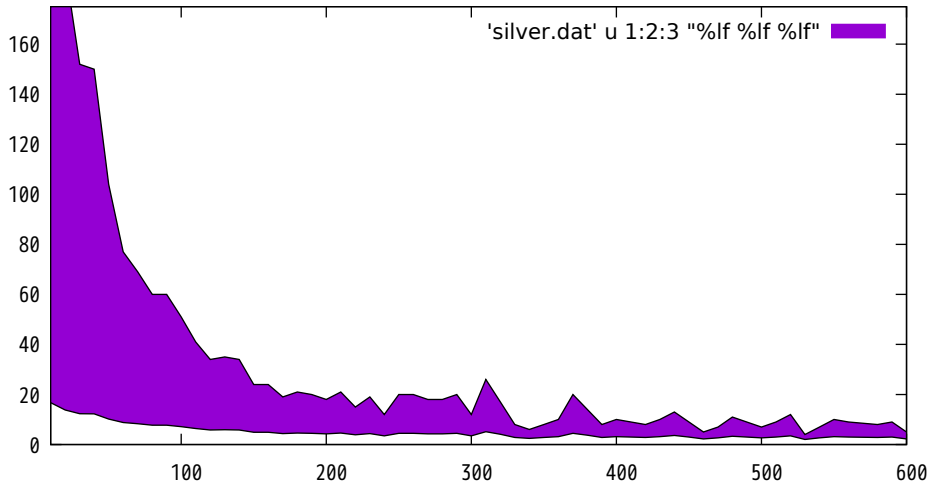

Fill area between two curves (pattern fill)

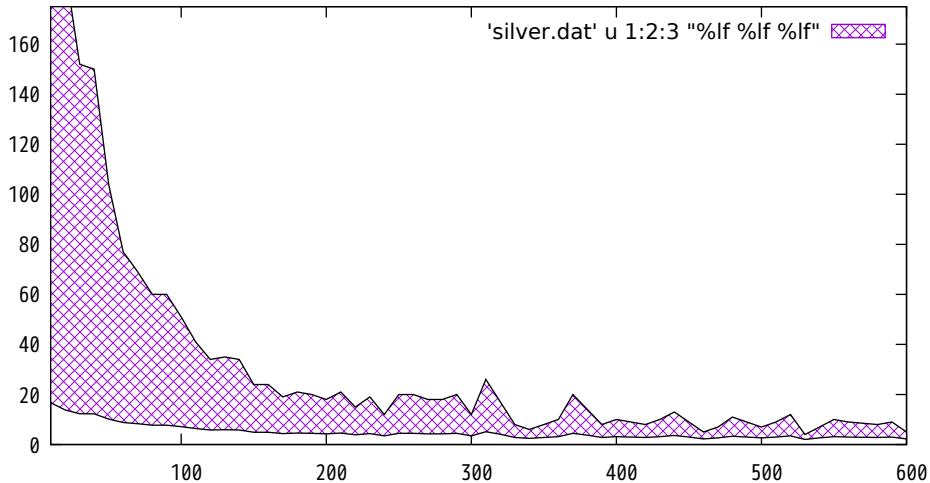

Fill area between two curves (above/below)

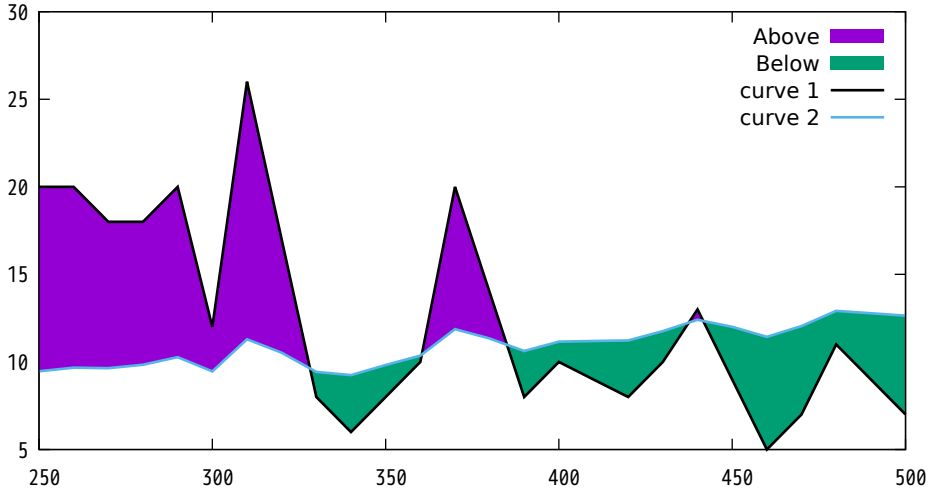

candlesticks with open boxes (default)

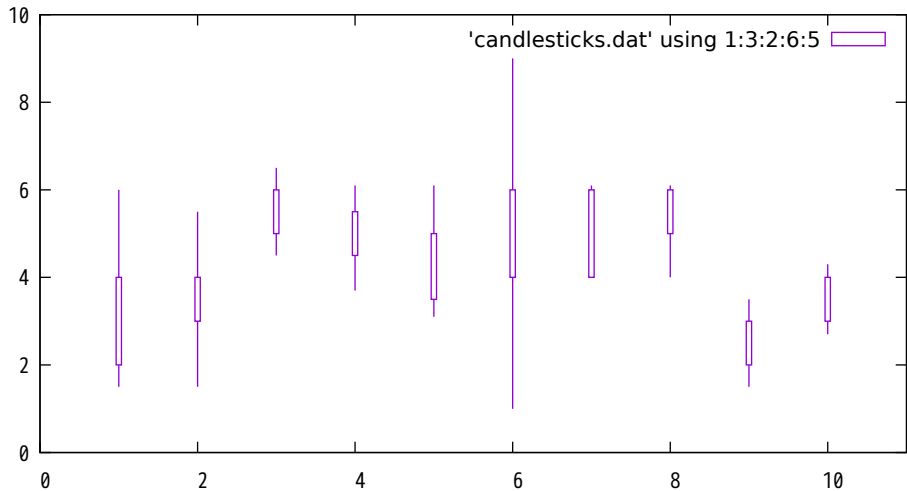



candlesticks with specified boxwidth

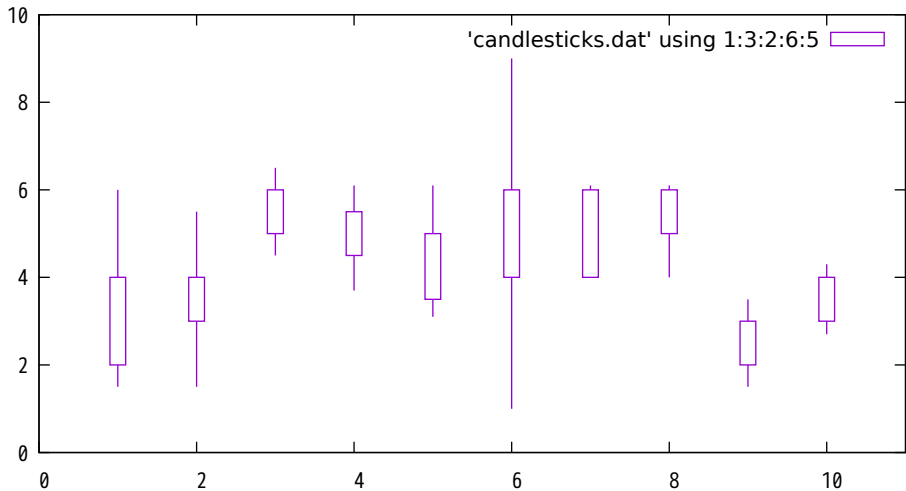

candlesticks with style fill solid

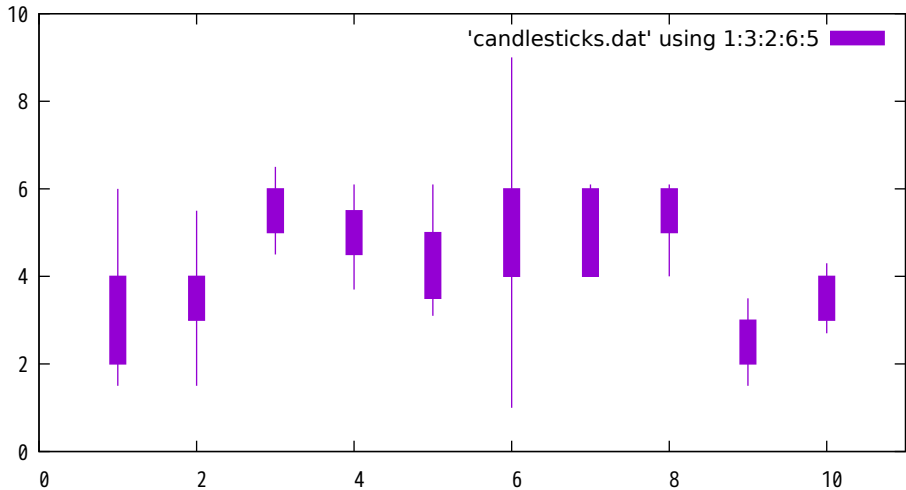

candlesticks showing both states of open/close

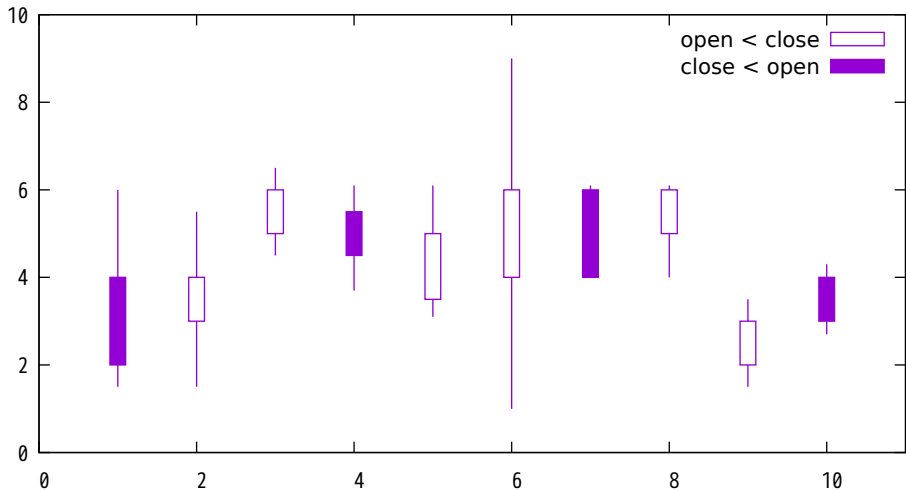

box-and-whisker plot adding median value as bar

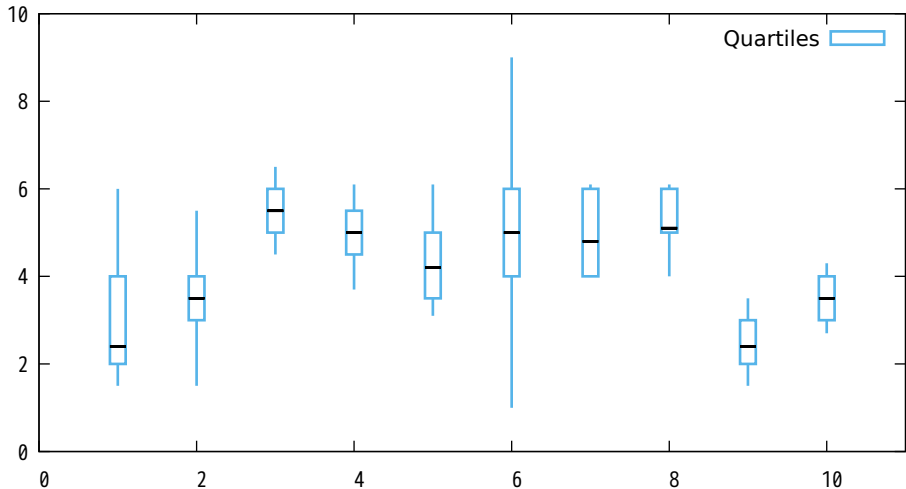

box-and-whisker with median bar and whiskerbars

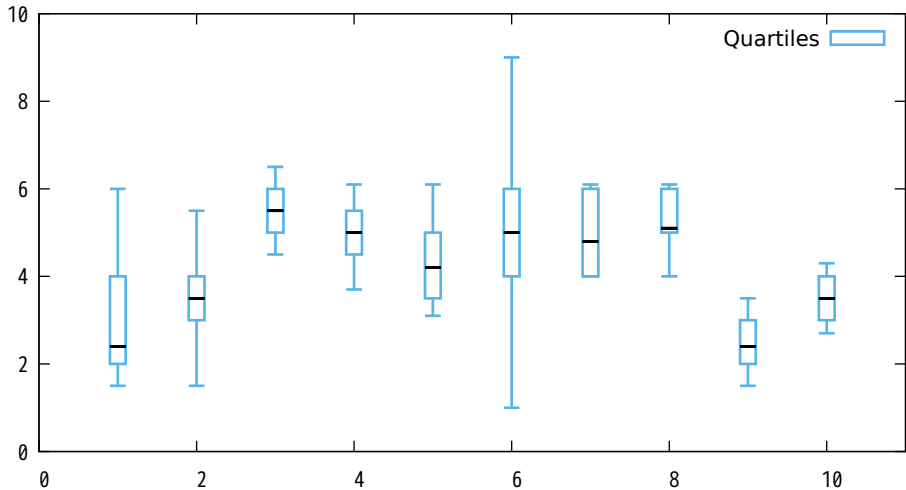

# Autoscaling with constraints (y-axis always unaffected)

## unconstrained

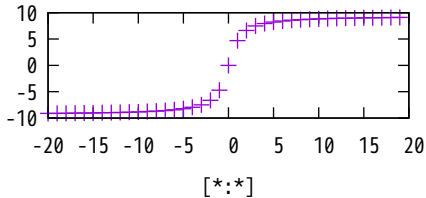

## minimum range guaranteed

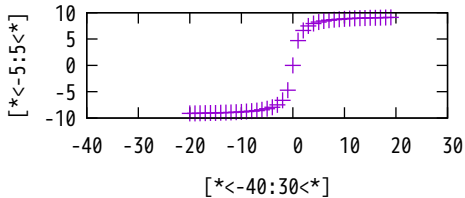

## clip to maximum range

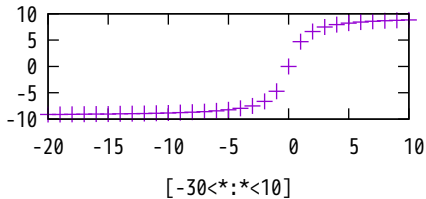

## mixed

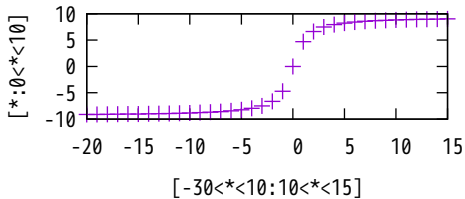

# Autoscaling with constraints (x-axis always unaffected)

## unconstrained

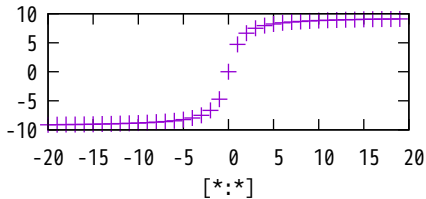

## minimum range guaranteed

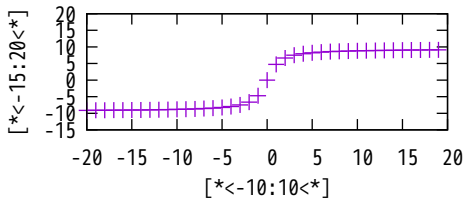

## clip to maximum range

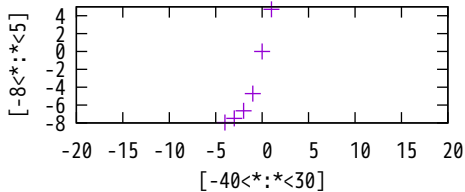

## mixed

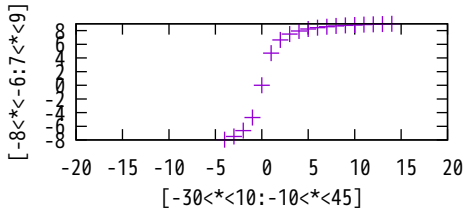

# Autoscaling with constraints

## autoscale xy

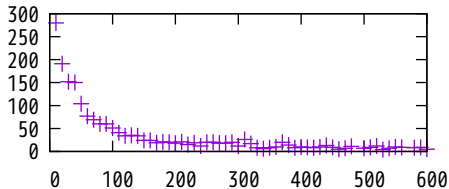

## set yrange [15<\*<25:\*)

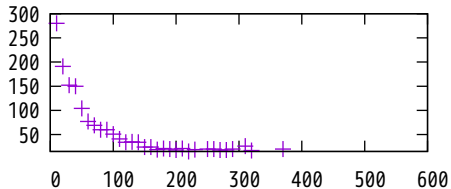

## set autoscale ymin

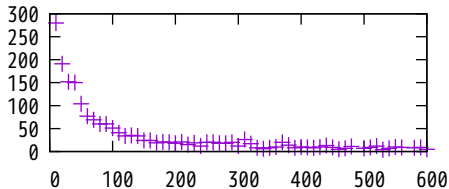

## set yrange [15<\*<25:135<\*<225]

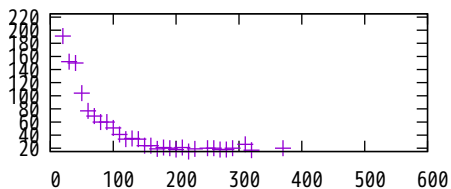



cubic spline fit to data (no weights)

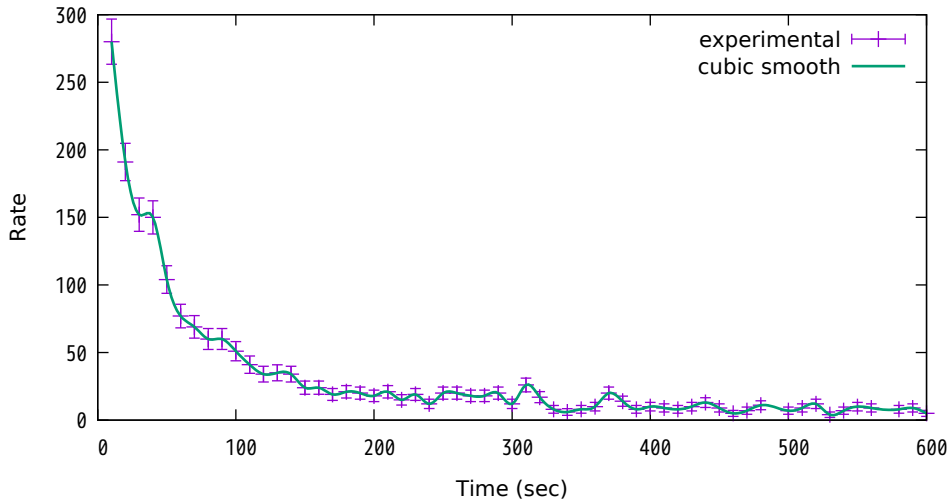

acsplines weighted by relative error

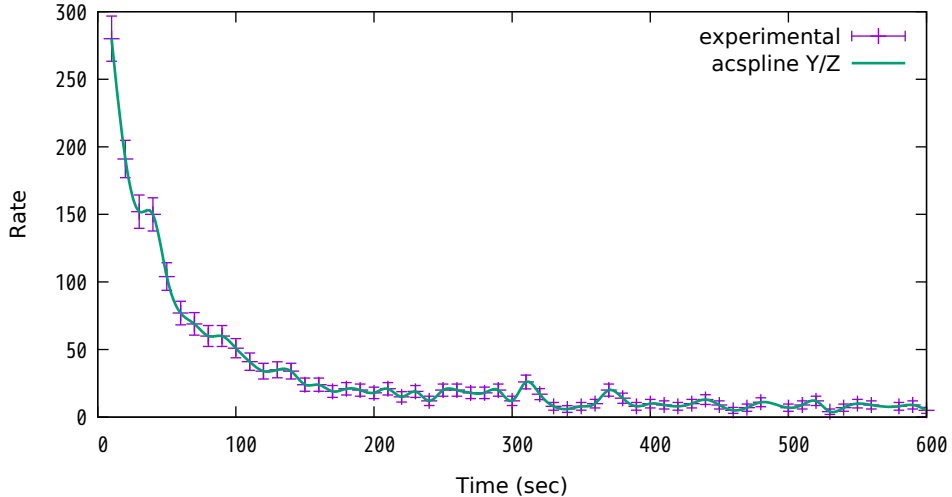

acsplines with increasing weight from error estimate

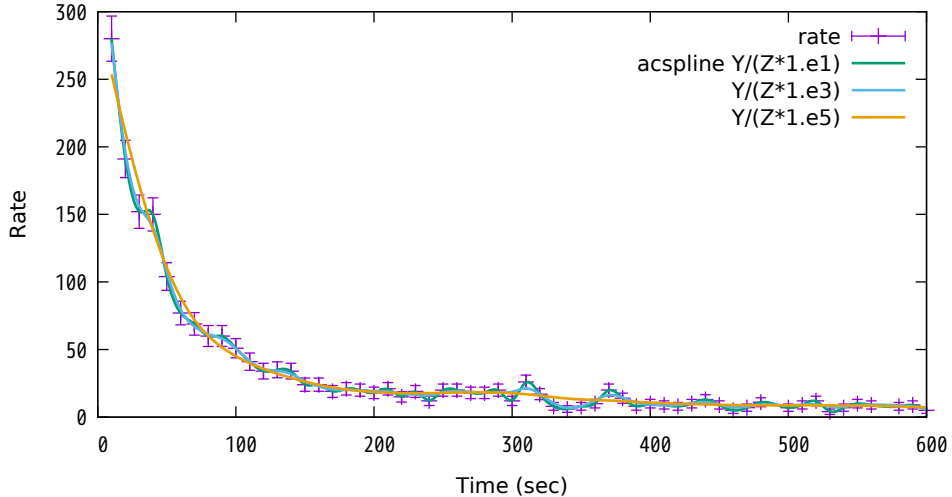

same plot (various weighting) in log scale

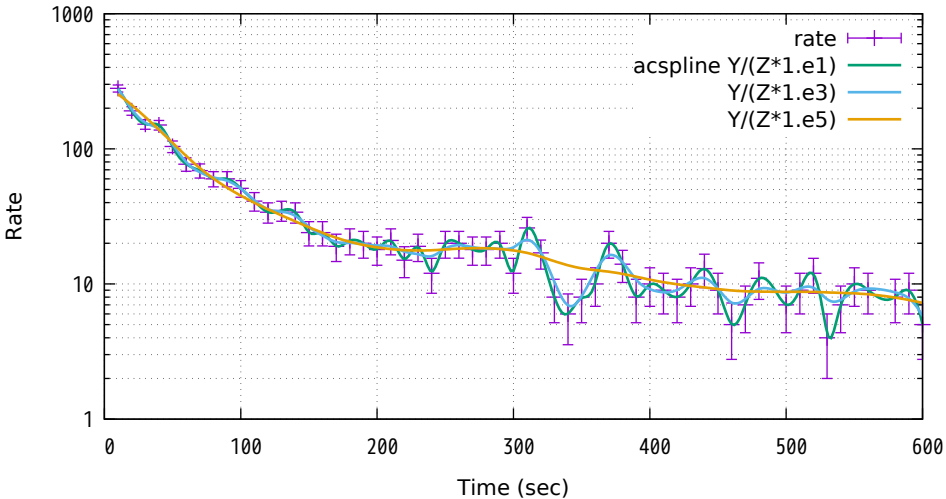

# Bezier curve rather than cubic spline

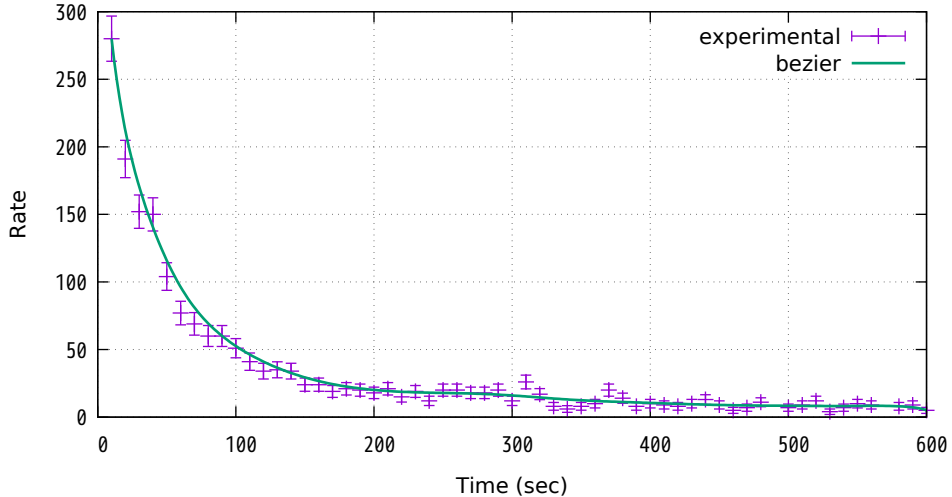

Bezier curve with log scale

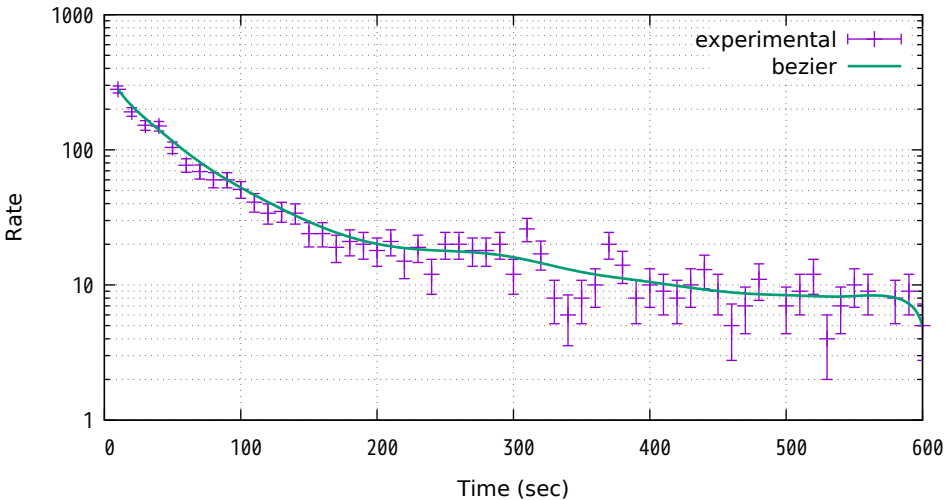

Monotonic cubic splines

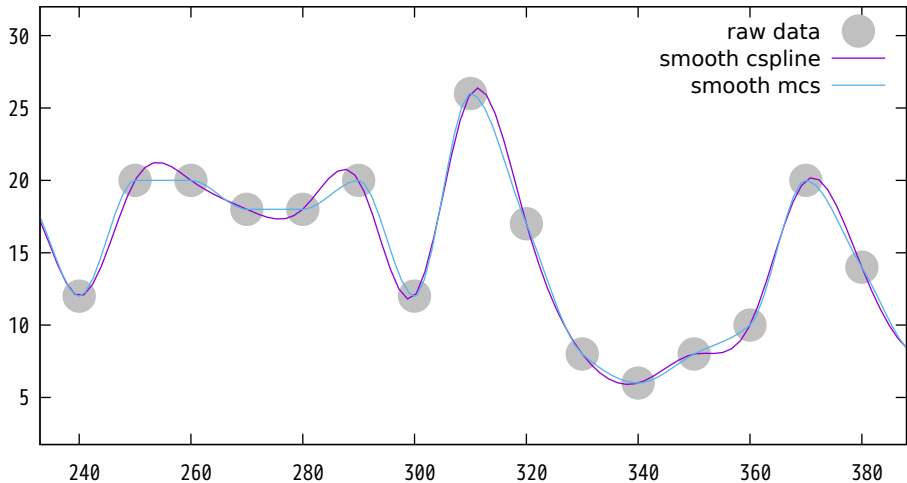

Monotonic cubic splines (log-scale data)

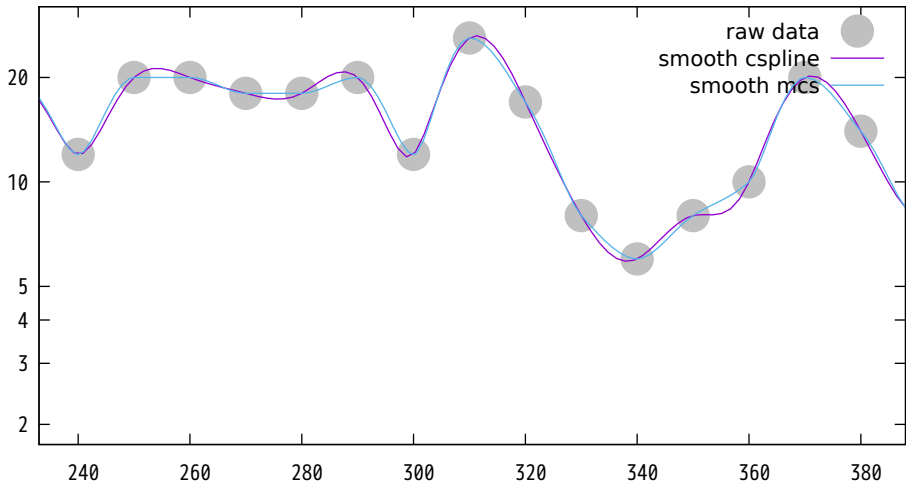



error represented by xyerrorbars

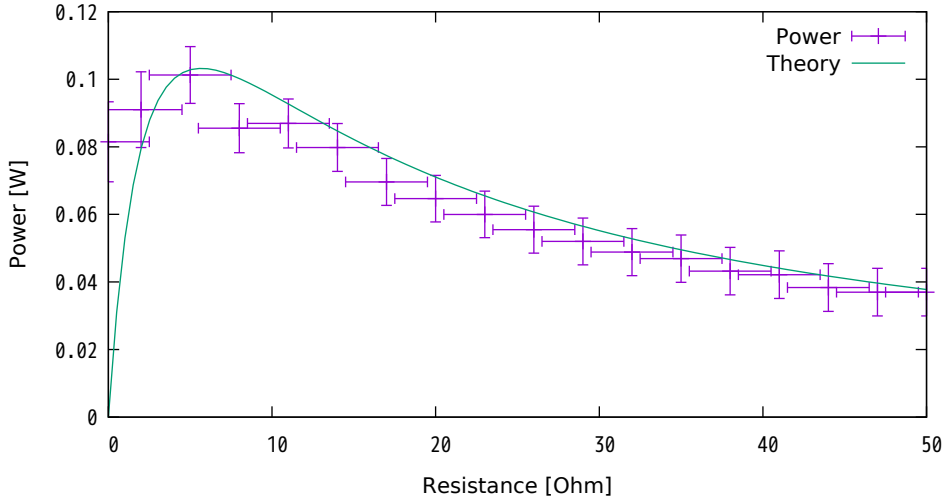

error represented by boxxyerror

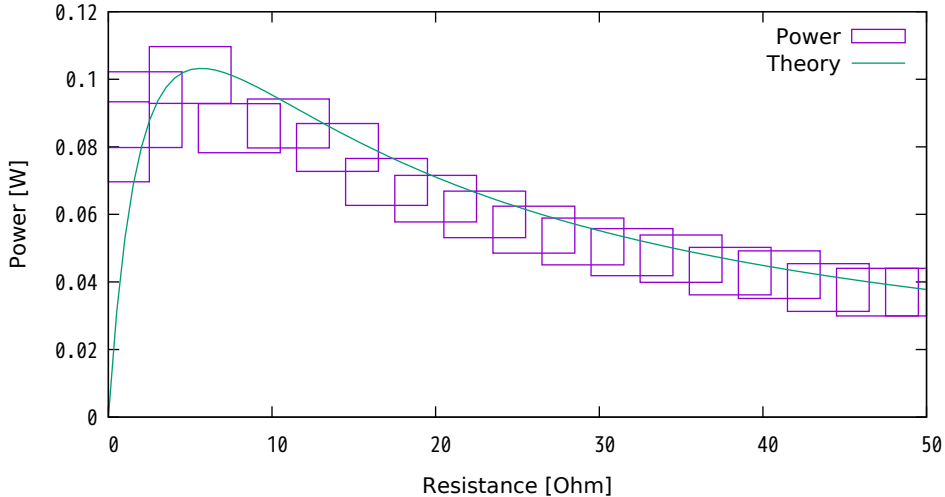

error represented by xerrorbars

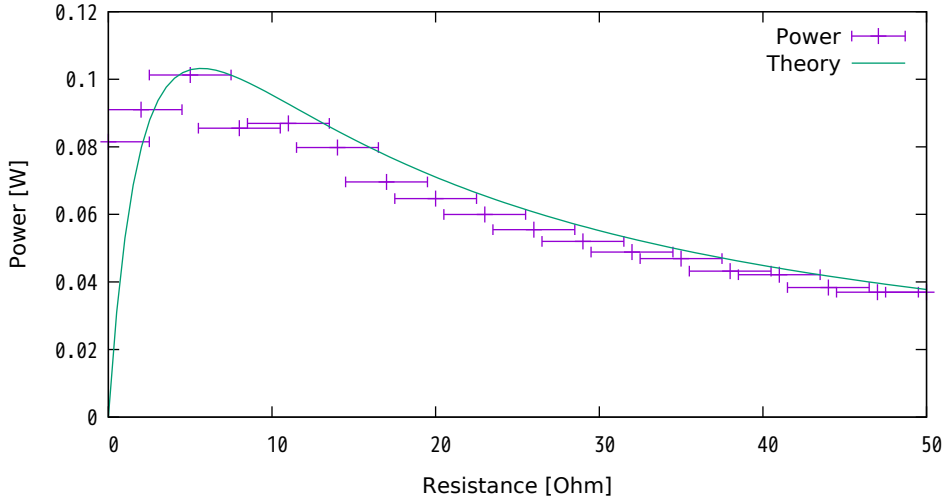

error represented by yerrorbars

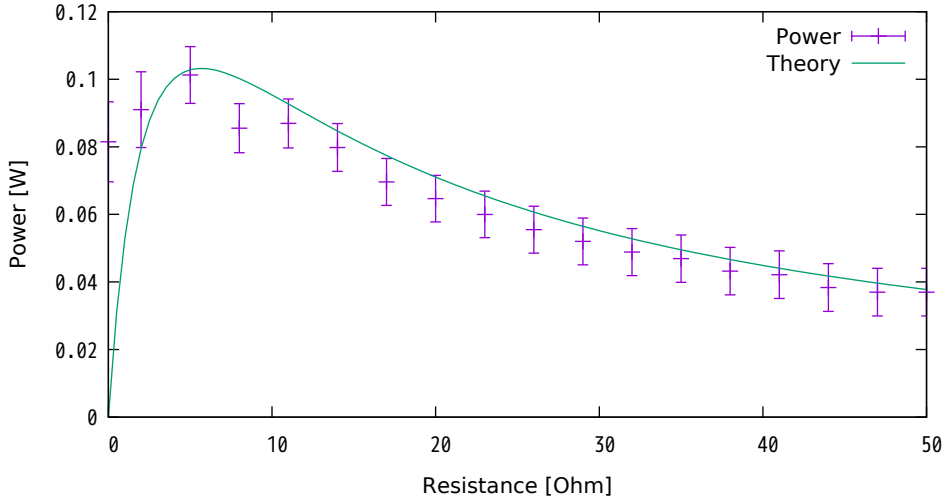

yerrorbars in log scale

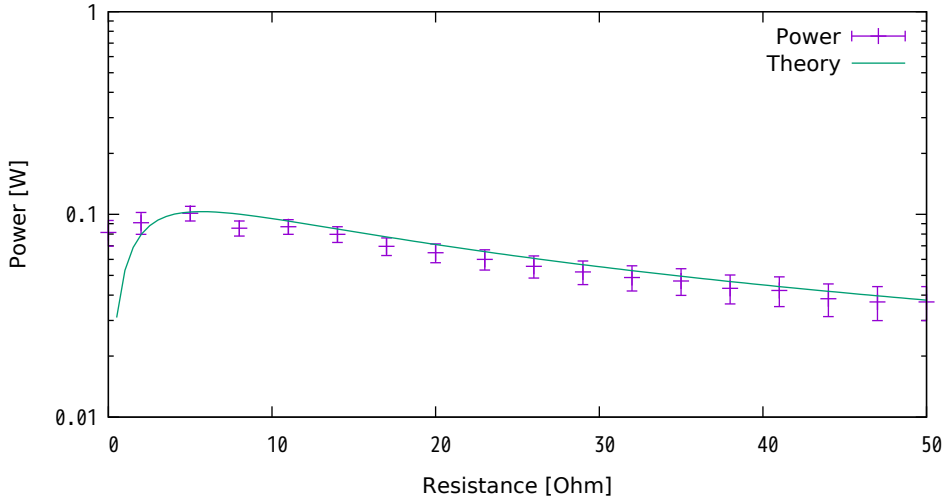

xyerrorbars in log scale

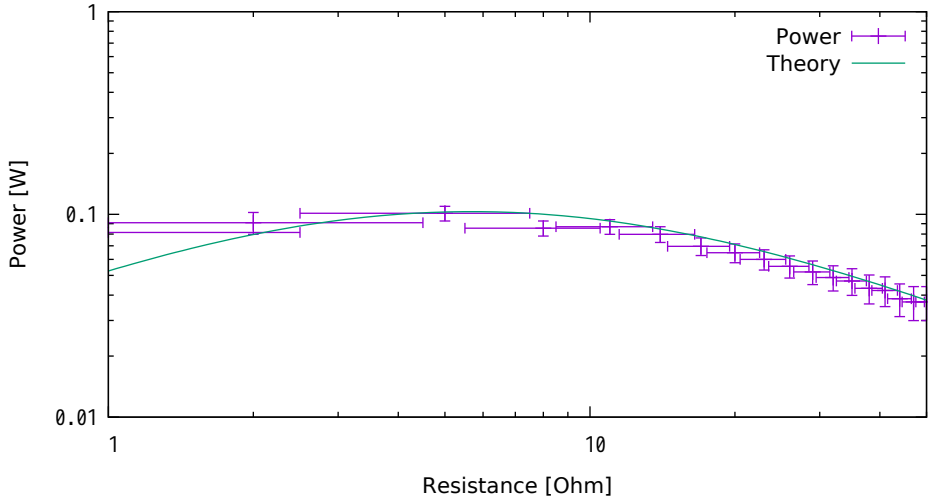

xyerrorbars with no crossbar

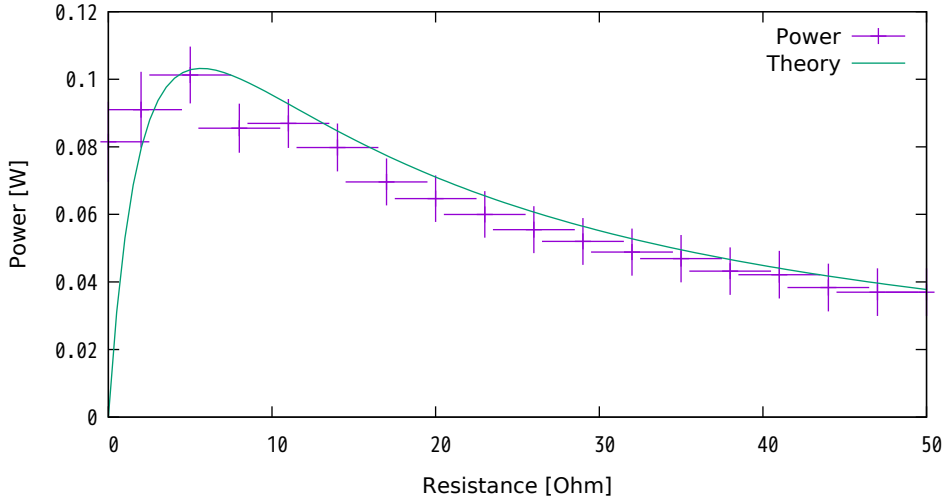

xerrorbars with no crossbar

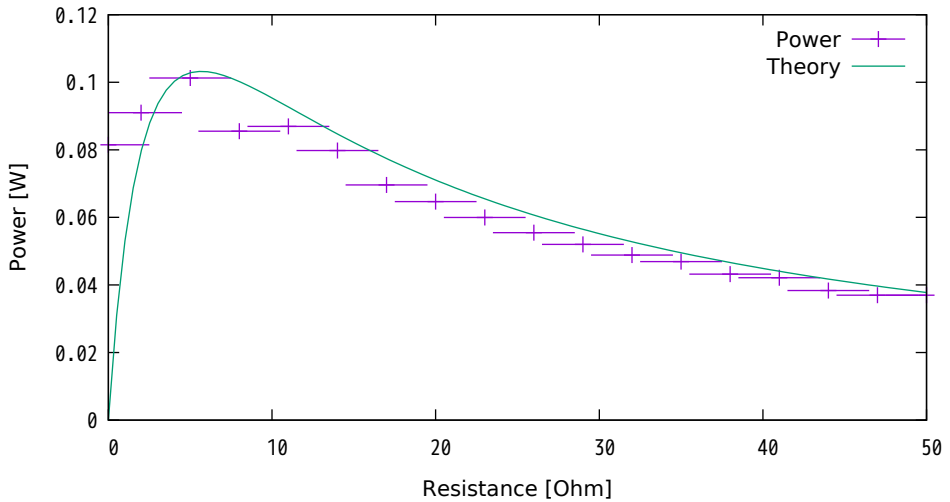



yerrorbars with no crossbar

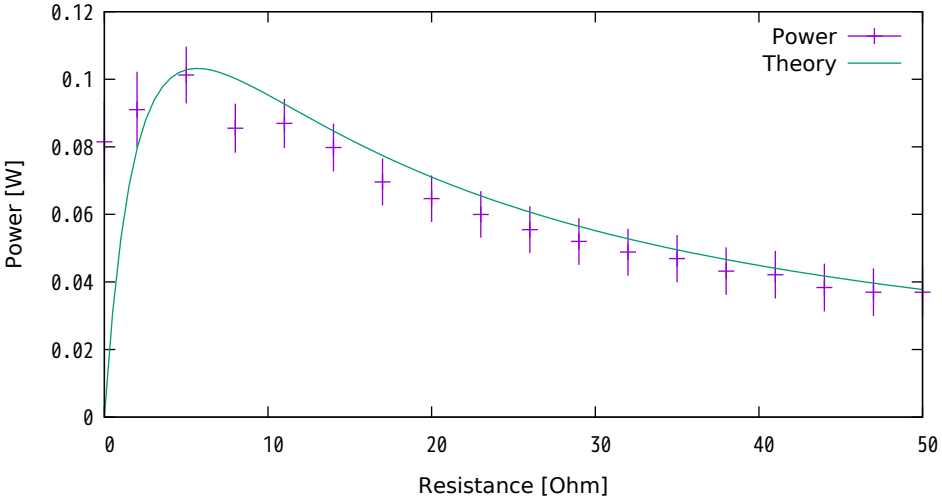

Error on y represented by filledcurve shaded region

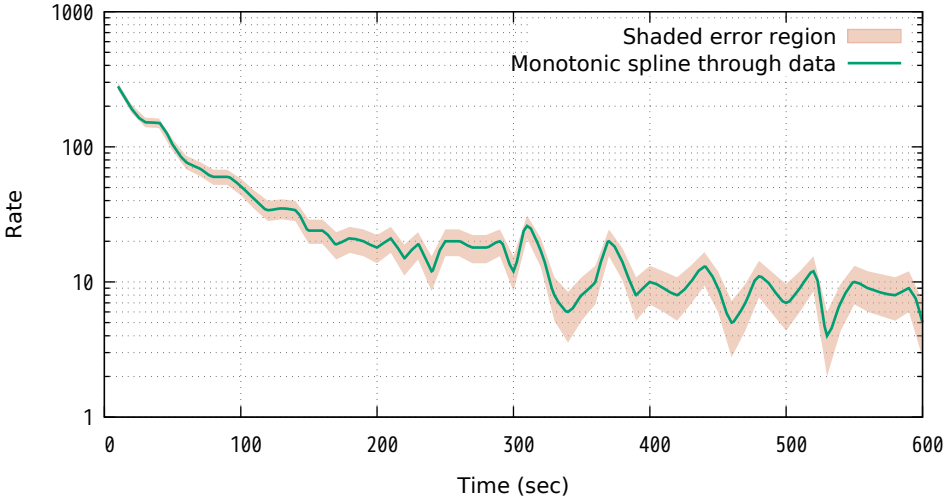

plot with zerrorfill (no depth sorting)

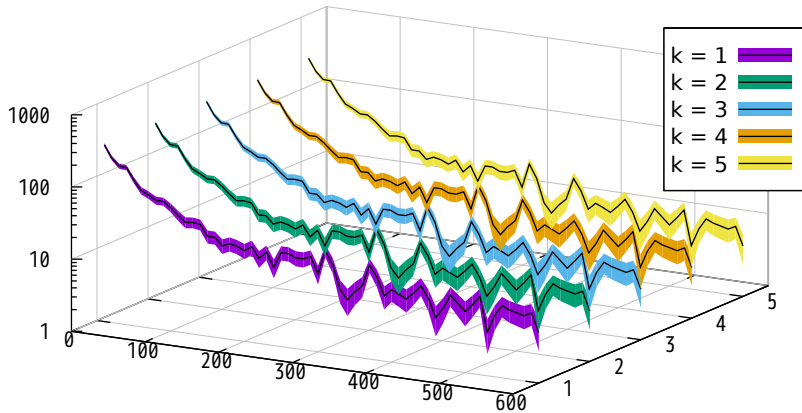

plot with zerrorfill (set pm3d depthorder)

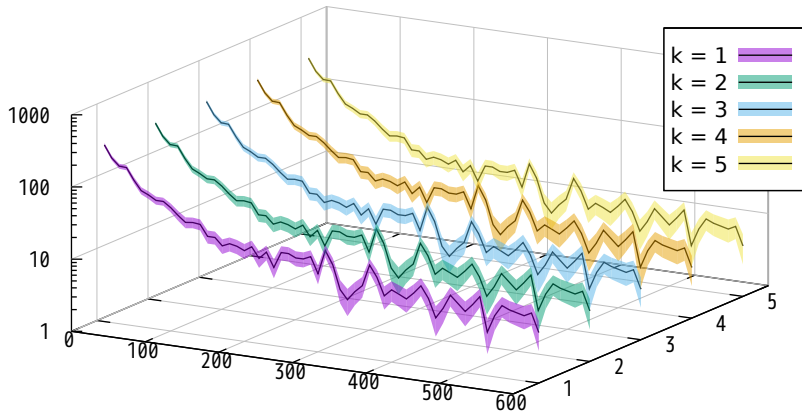

fence plot constructed with zerrorfill

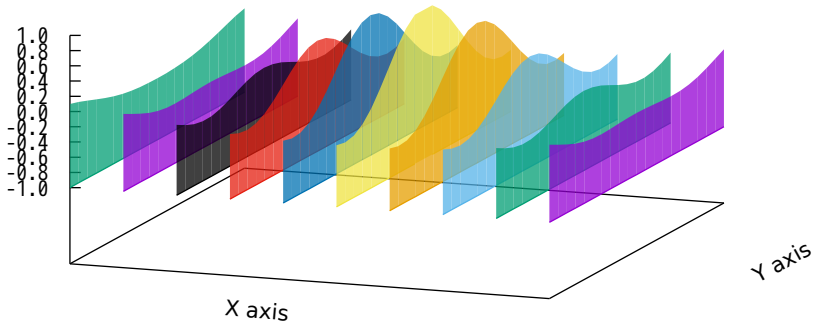

data set and initial parameters

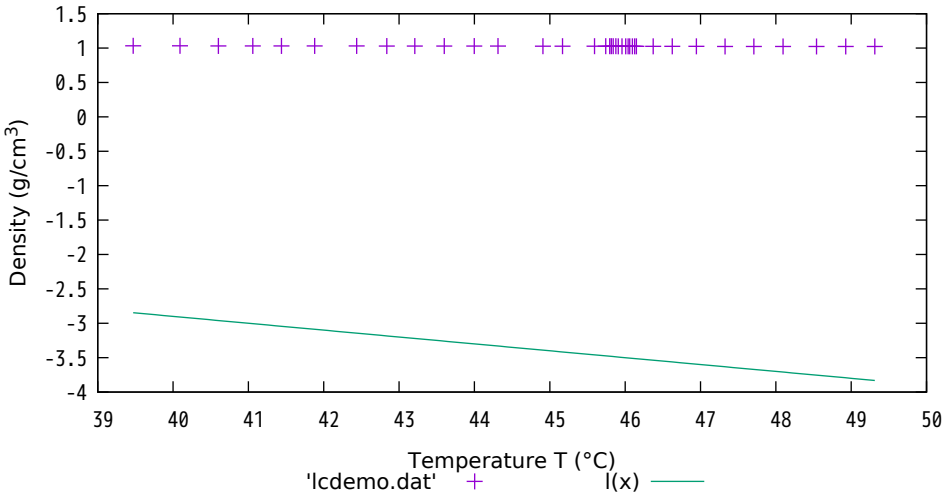

unweighted fit

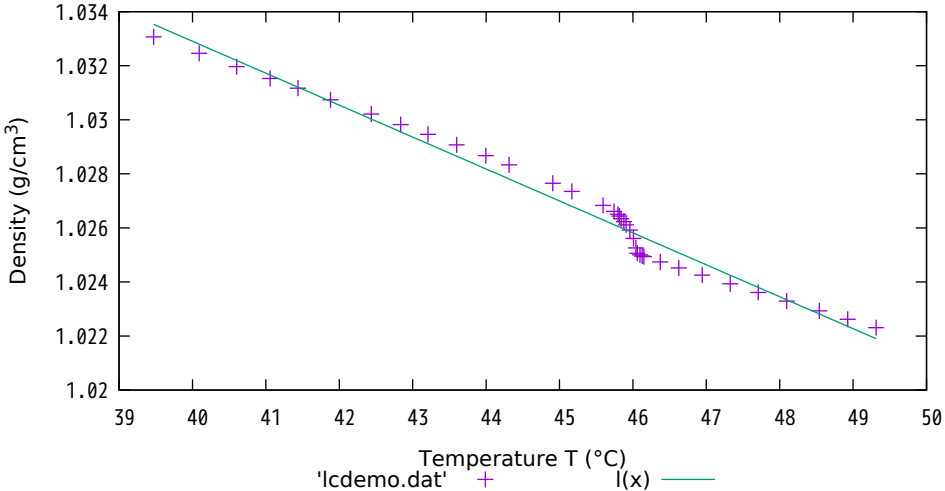

data with experimental weights

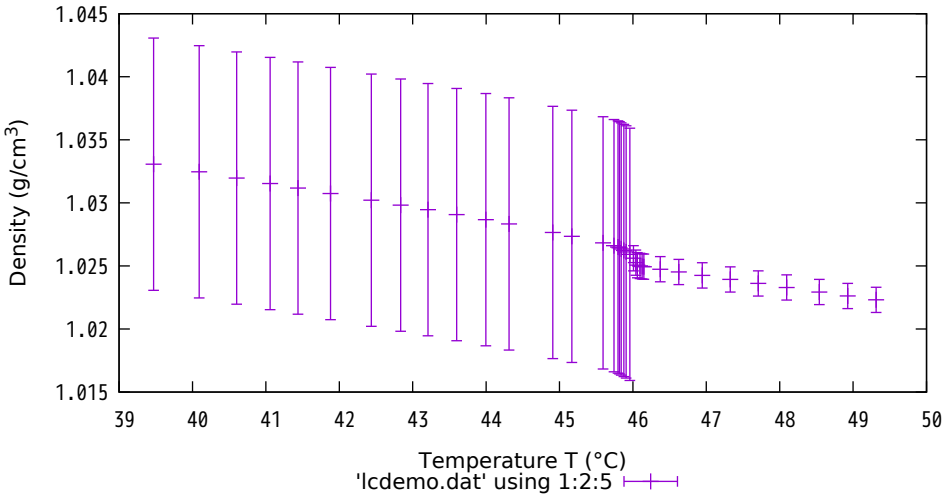



fit weighted by experimental weights

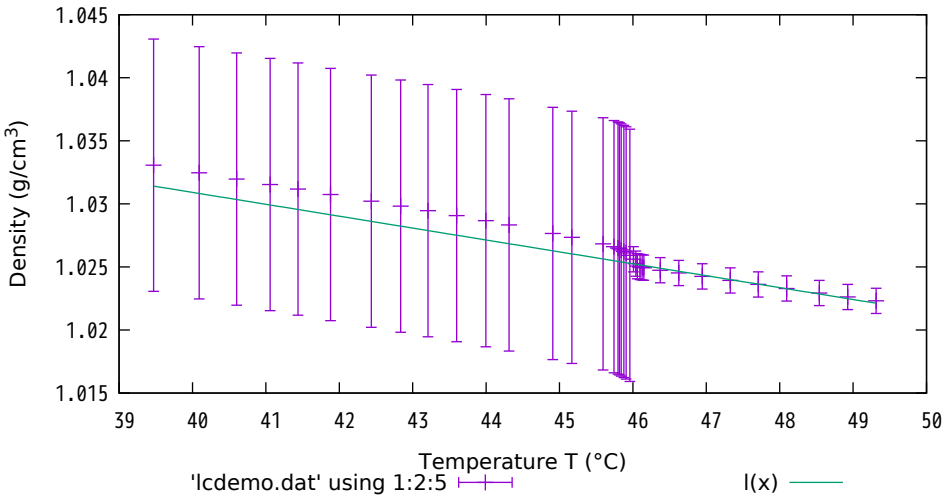

initial parameters for realistic model function

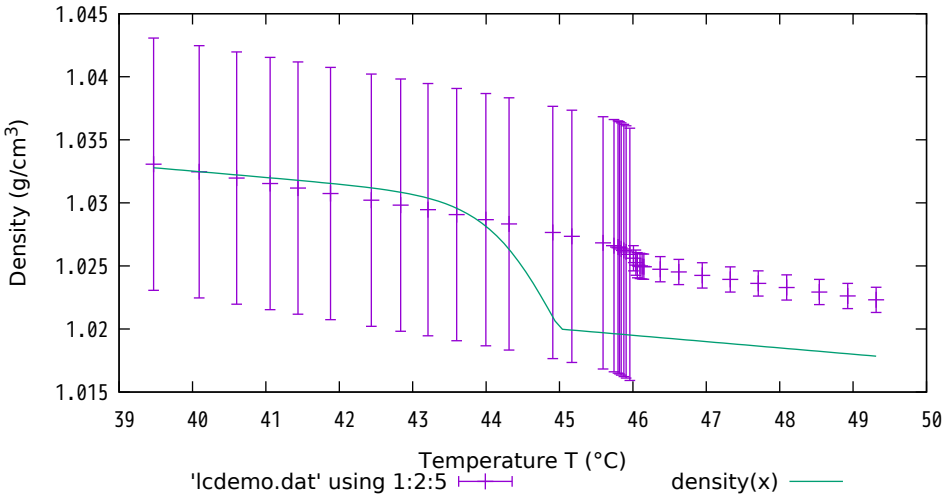

fitted to realistic model function

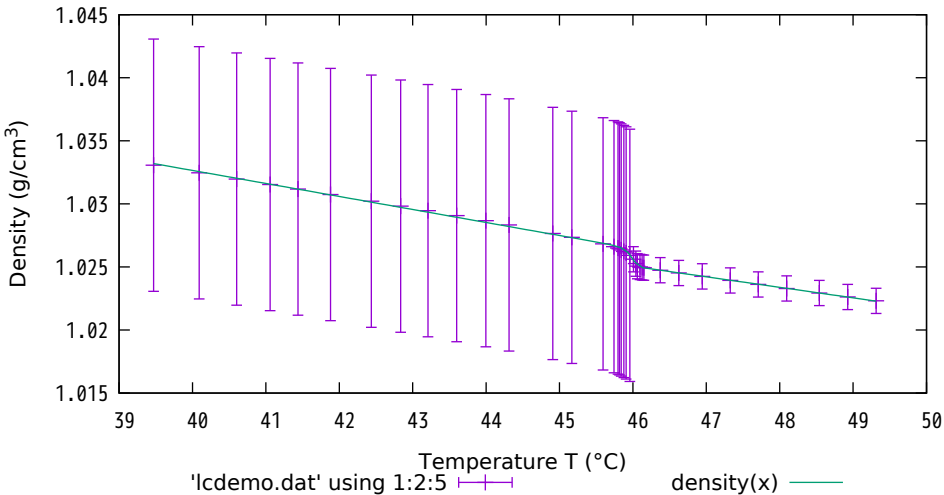

the scattered points, and the initial parameter

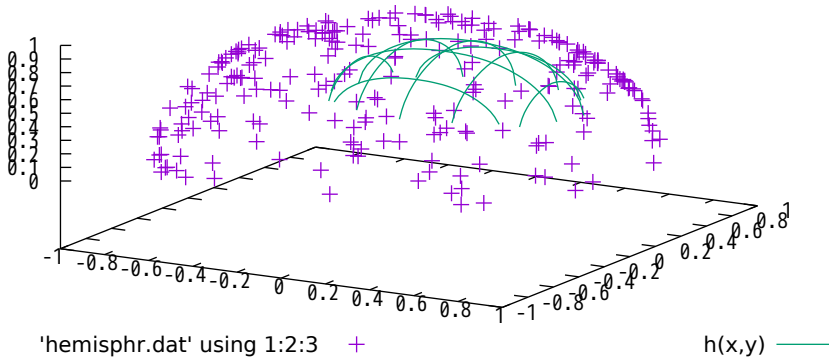

the scattered points, fitted curve

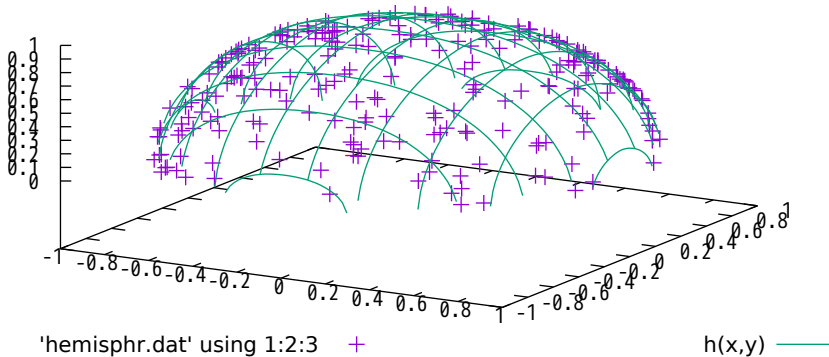

sound data, and model with initial parameters

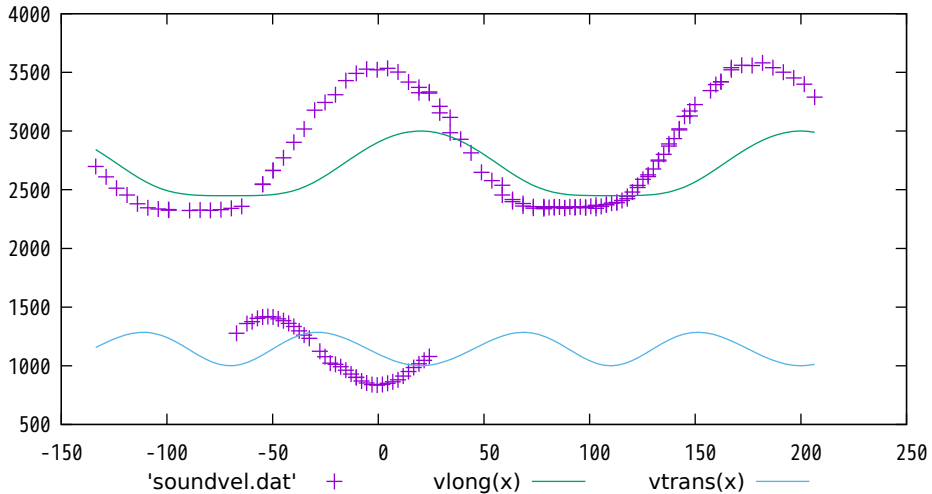

pseudo-3d multi-branch fit to velocity data

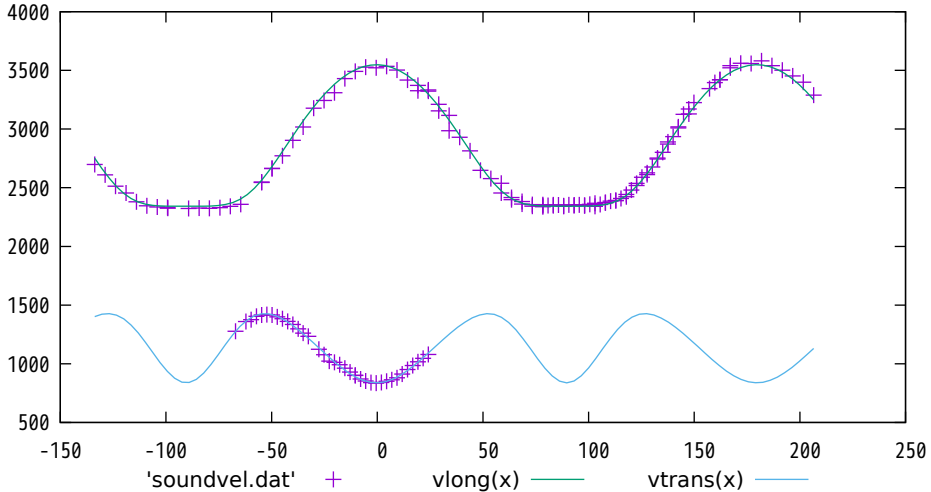

pseudo-3d multi-branch fit to velocity data

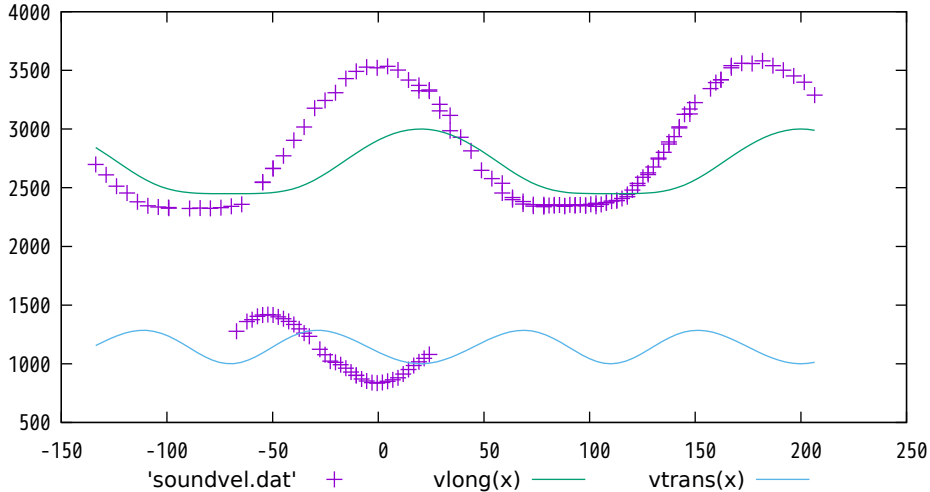



fitted only every 5th data point

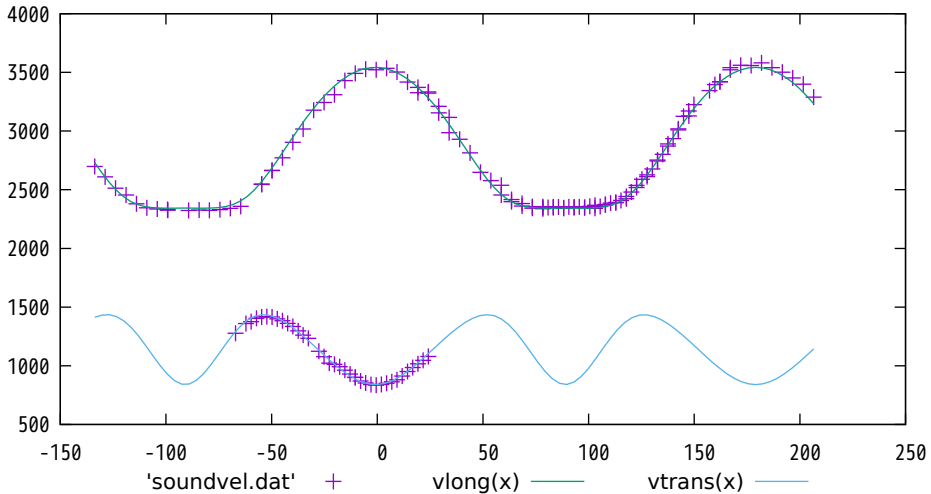

# initial parameters

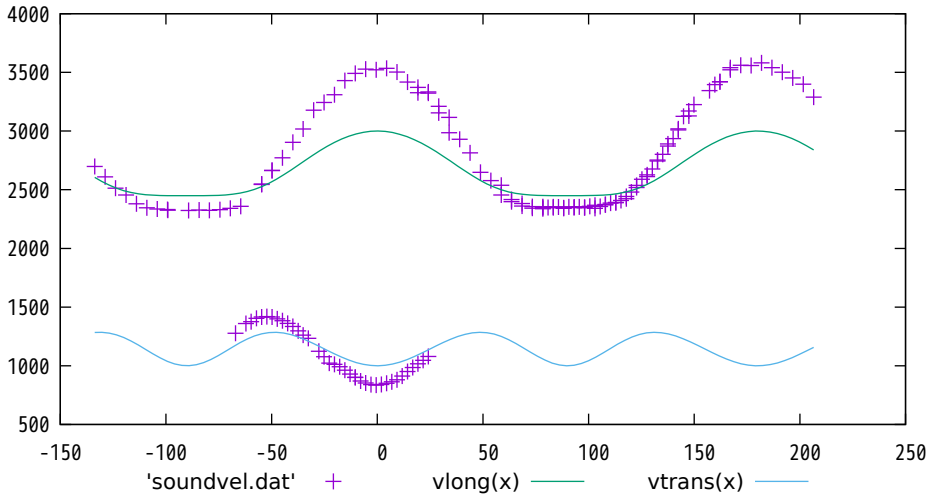

fit with c44 and c13 fixed

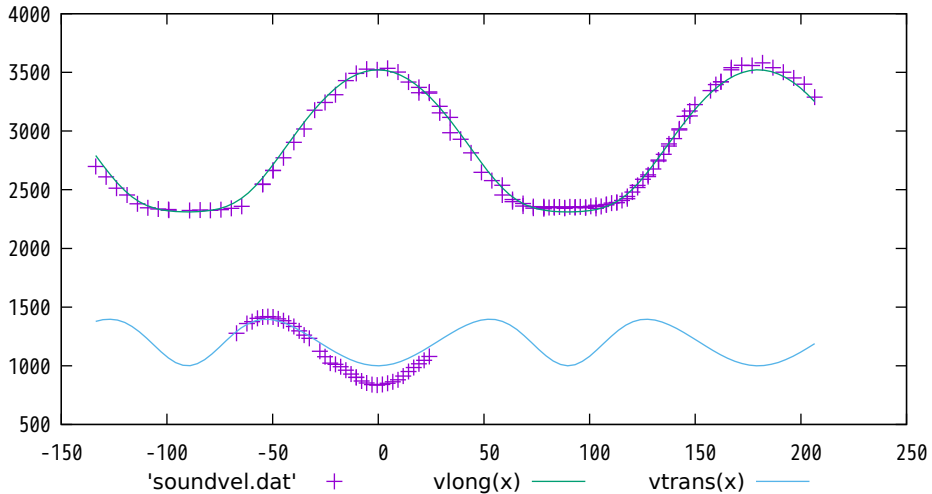

data and initial parameters

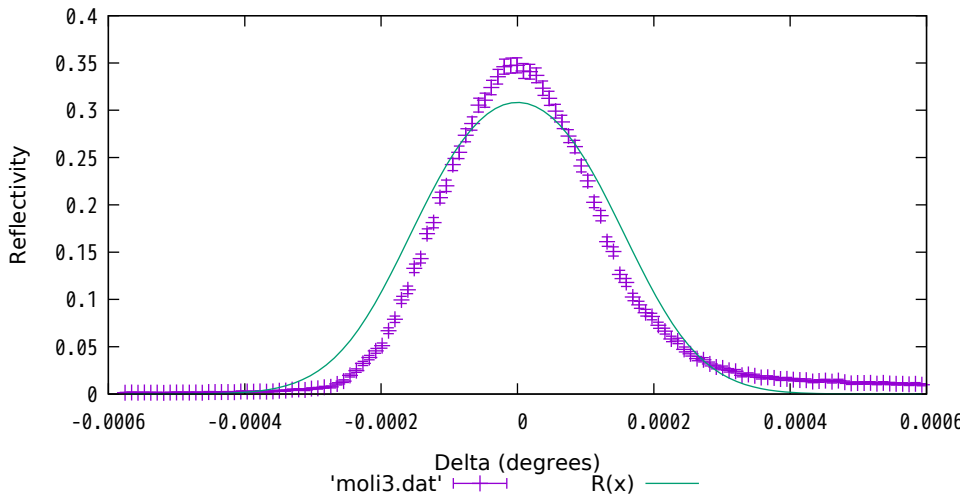

fitted parameters

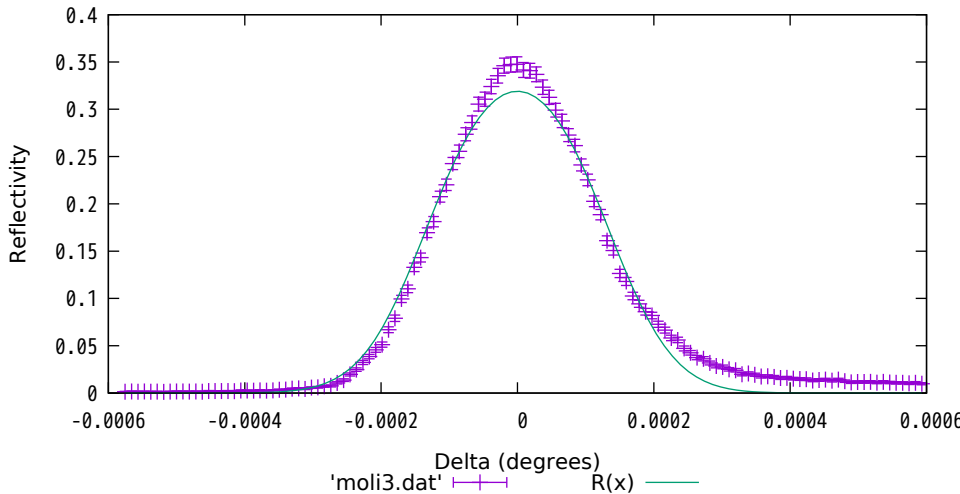

# data and initial parameters

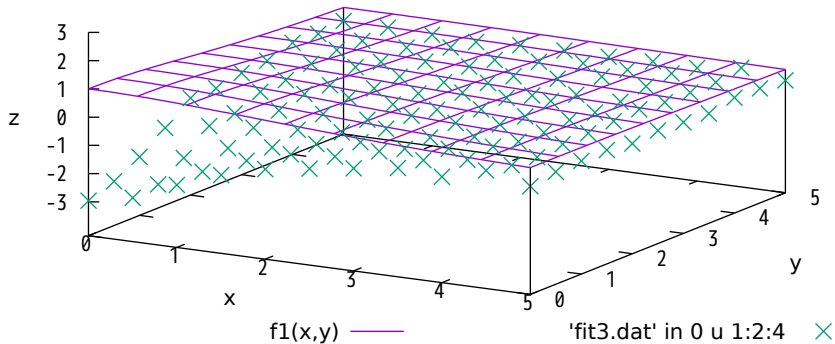

fit to data with  $t = -3$

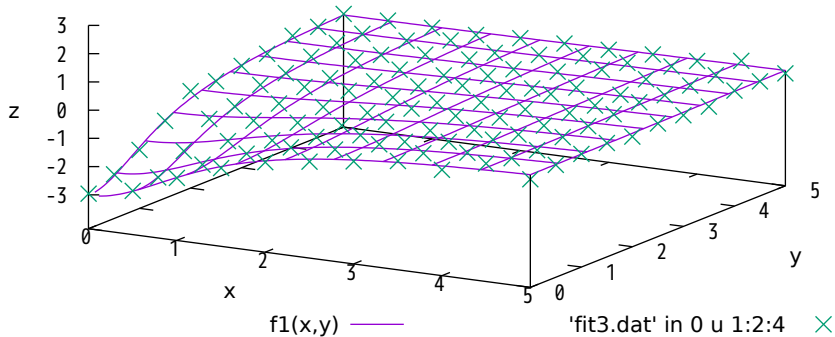

fit to data with  $t = +3$ , initial parameters

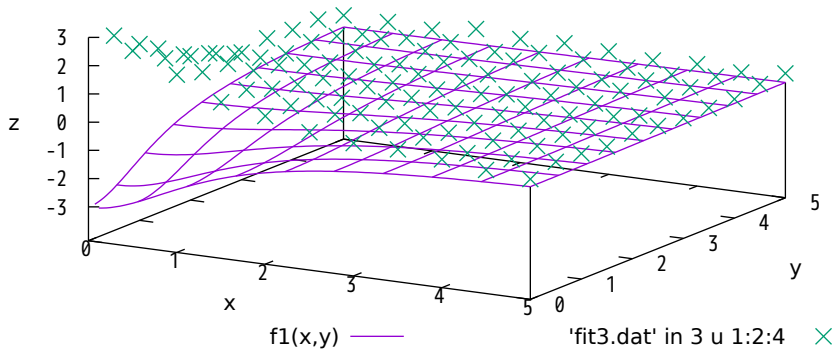



fit to data with  $t = +3$

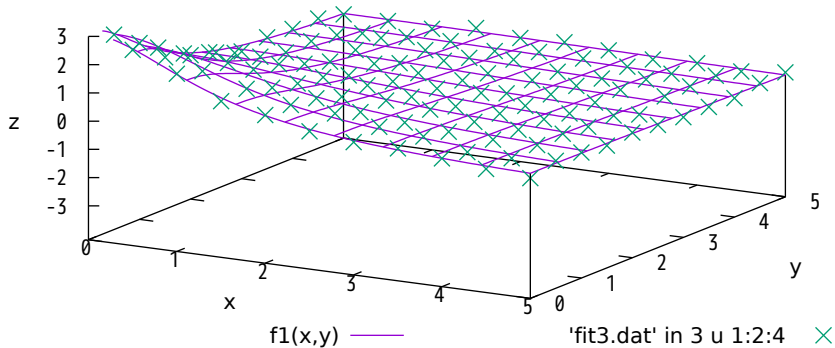

data for all indices t, initial parameters

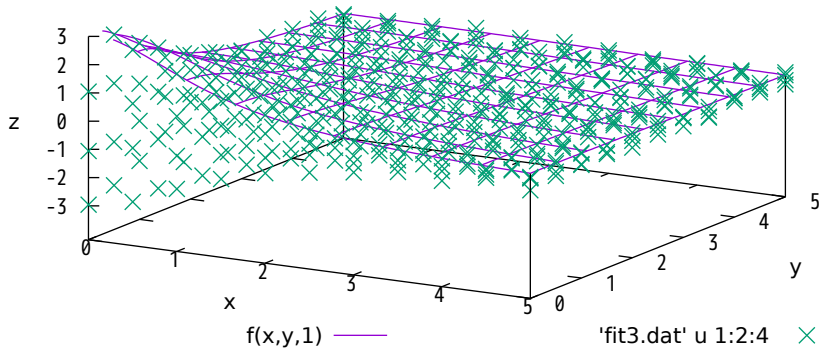

# fit to all data

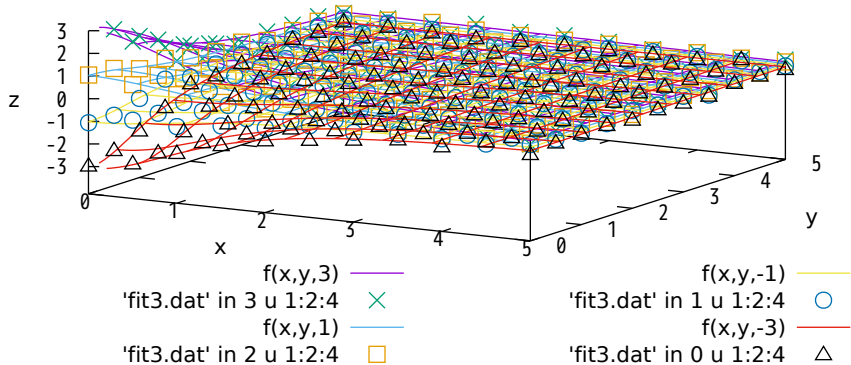

Pearson's data and York's weights  
original data and the initial function

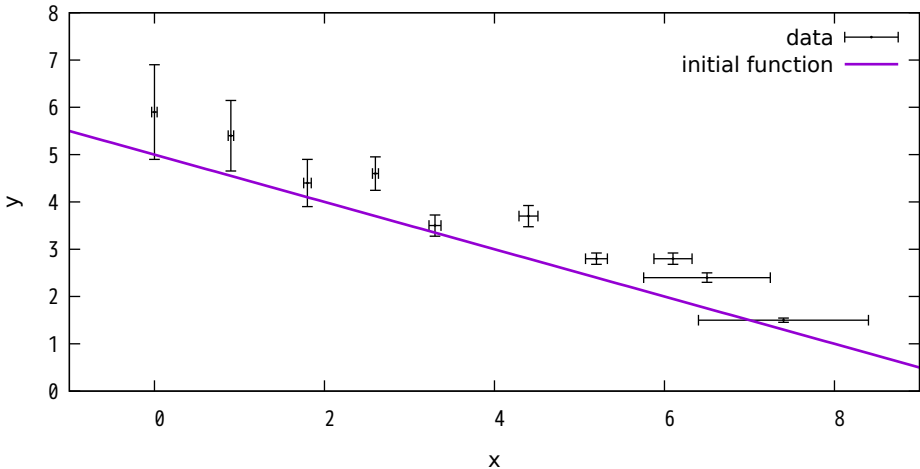

Pearson's data and York's weights  
function fit with no error terms

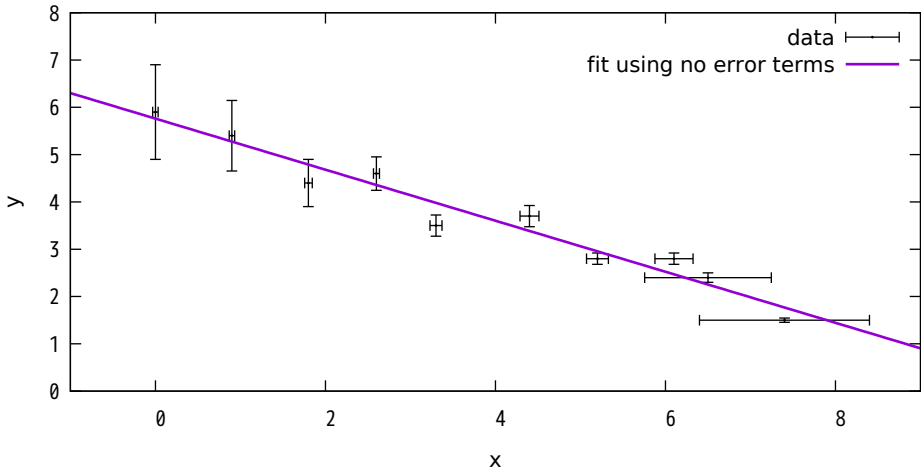

Pearson's data and York's weights  
function fit with yerror keyword

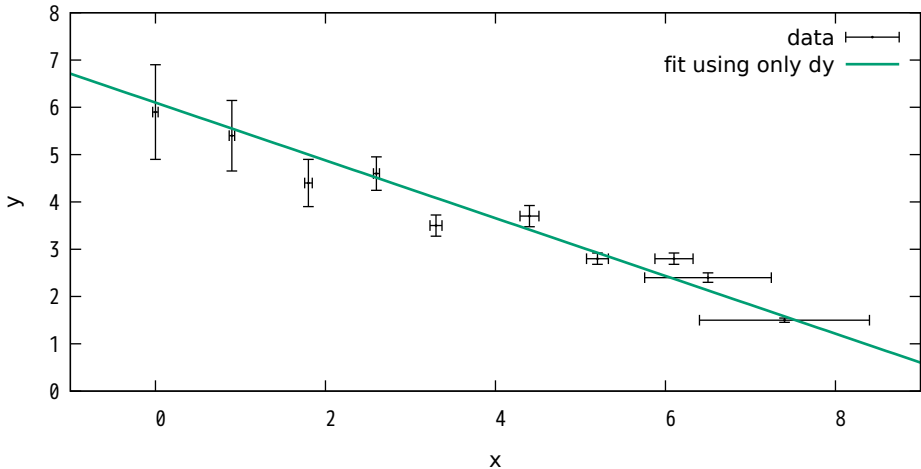

Pearson's data and York's weights  
function fit with xyerror keyword

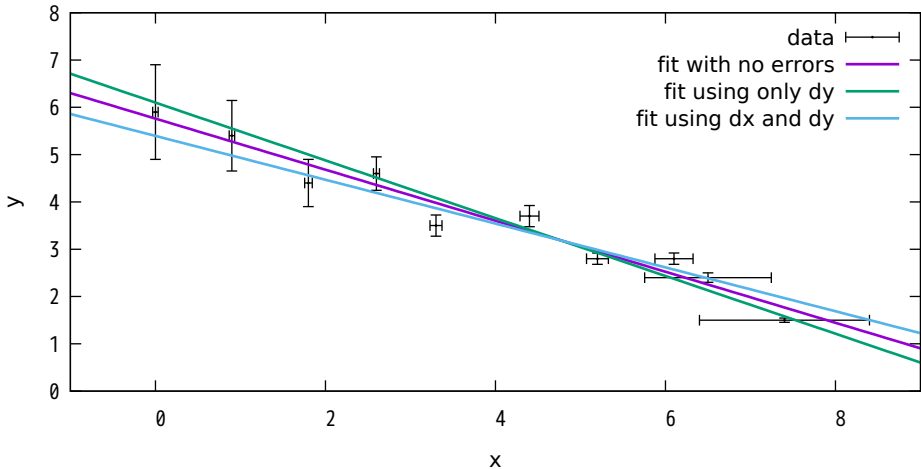

Plot a function of a named variable

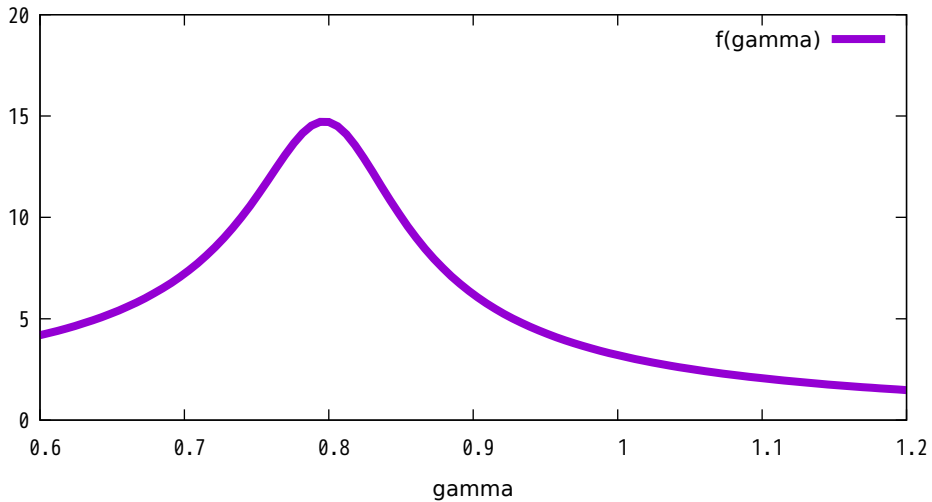



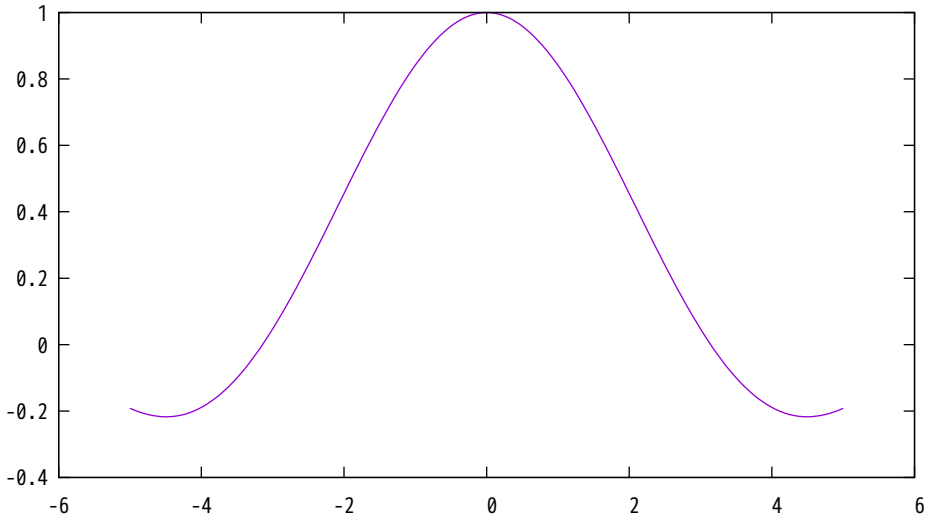

t, sin(t)/t or sin(x)/x —

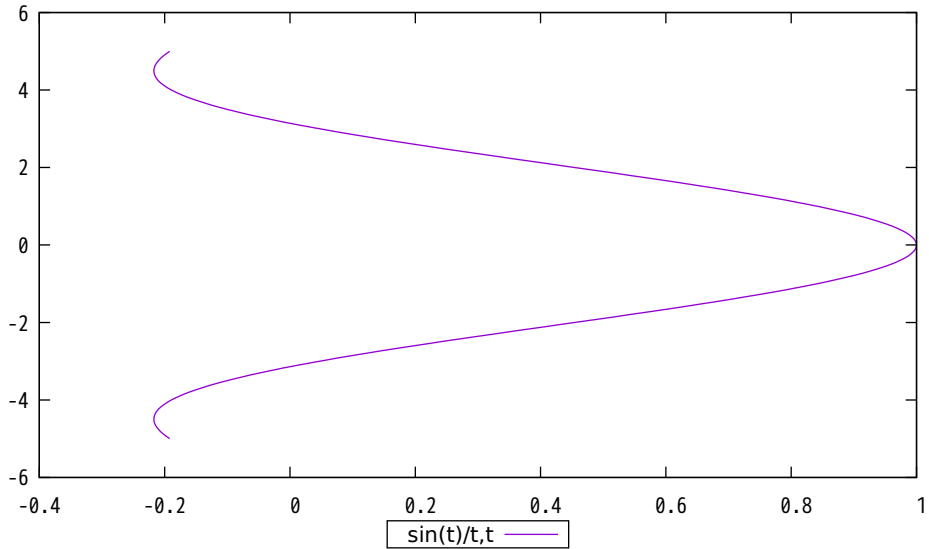

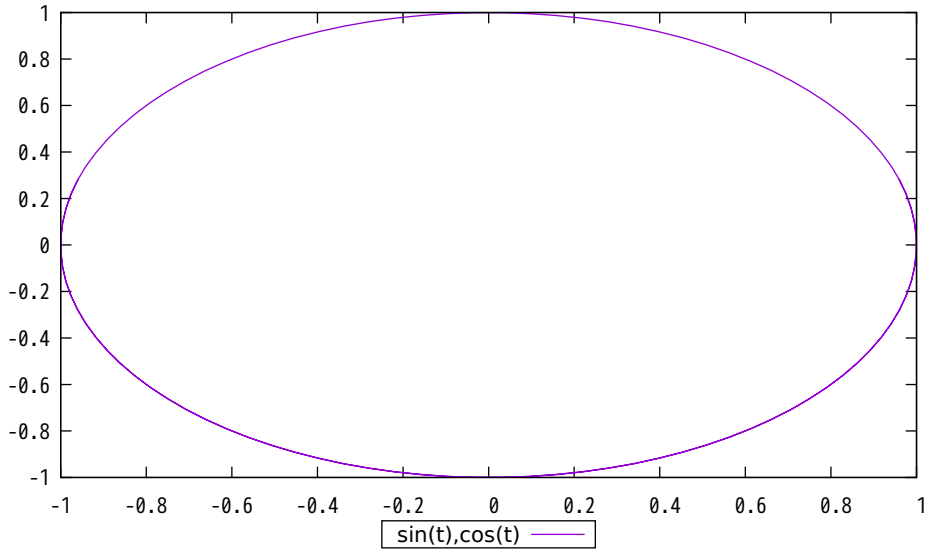

# Parametric Conic Sections

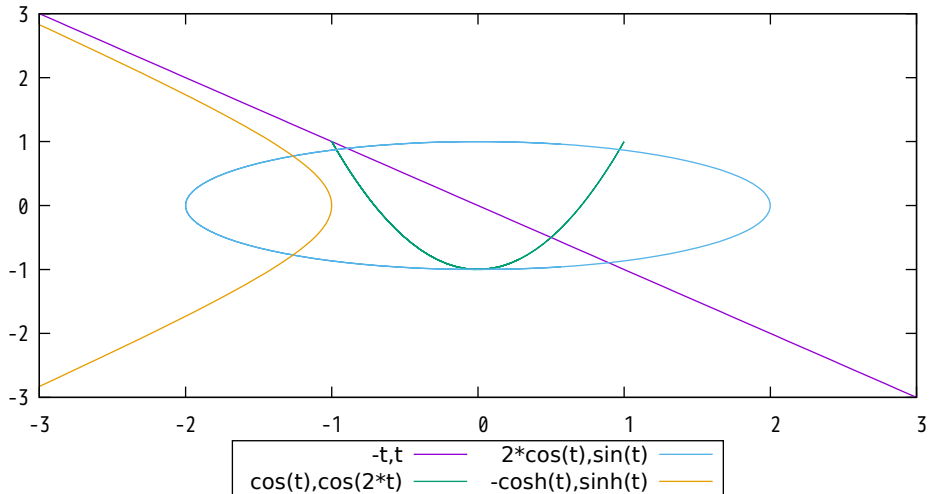

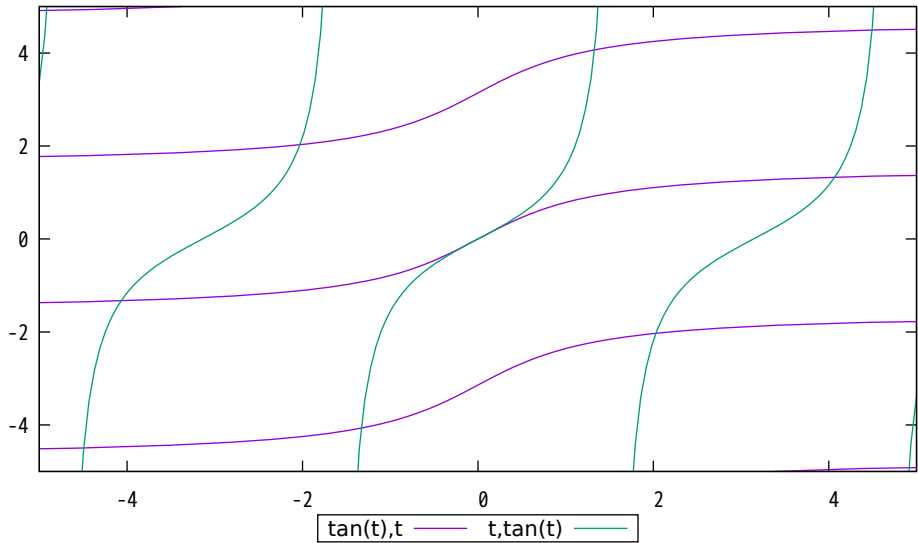

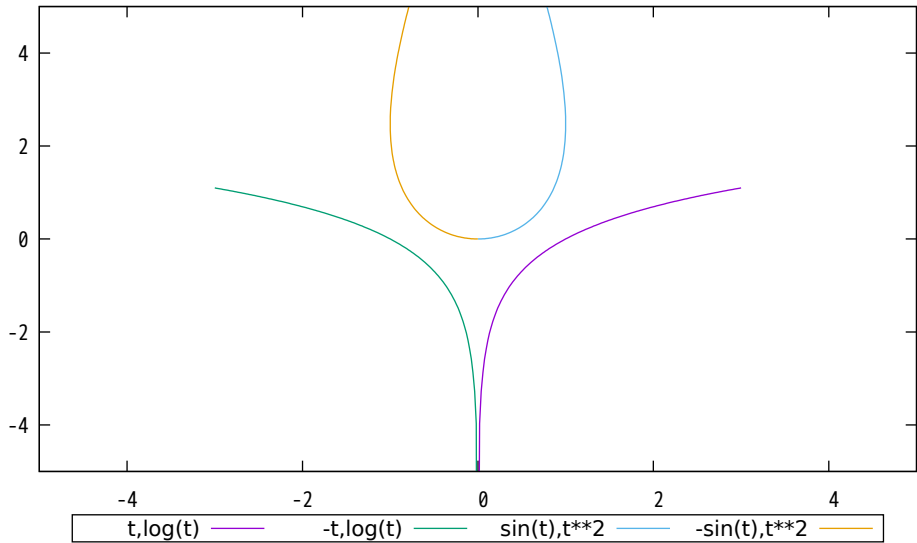

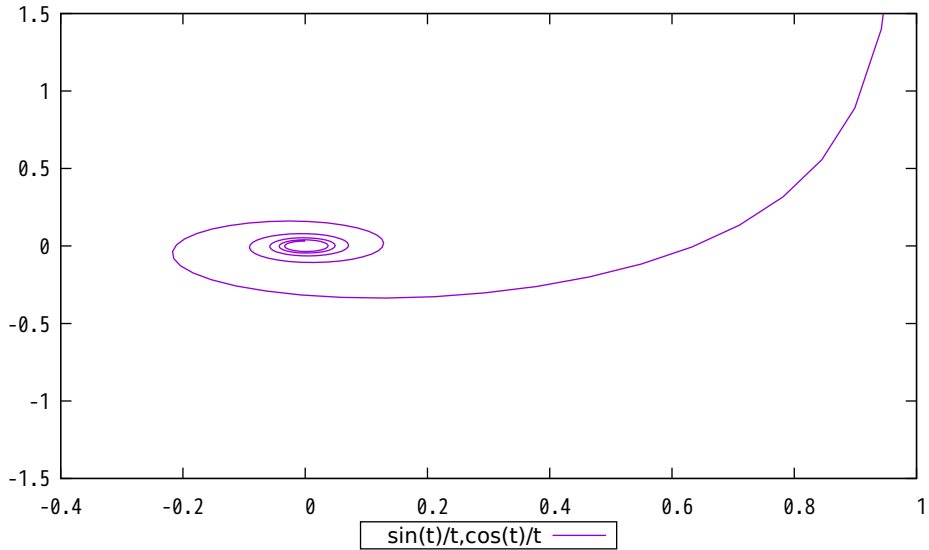

Decouple range of parametric axes  $u/v$   
from that of display axes  $x/y/z$

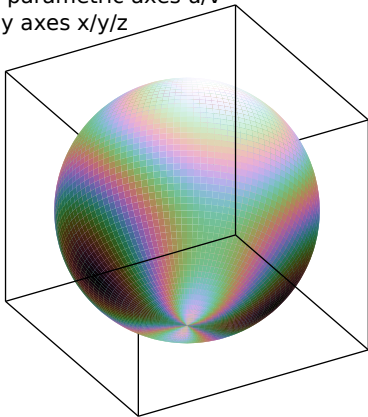



## Piecewise function sampling

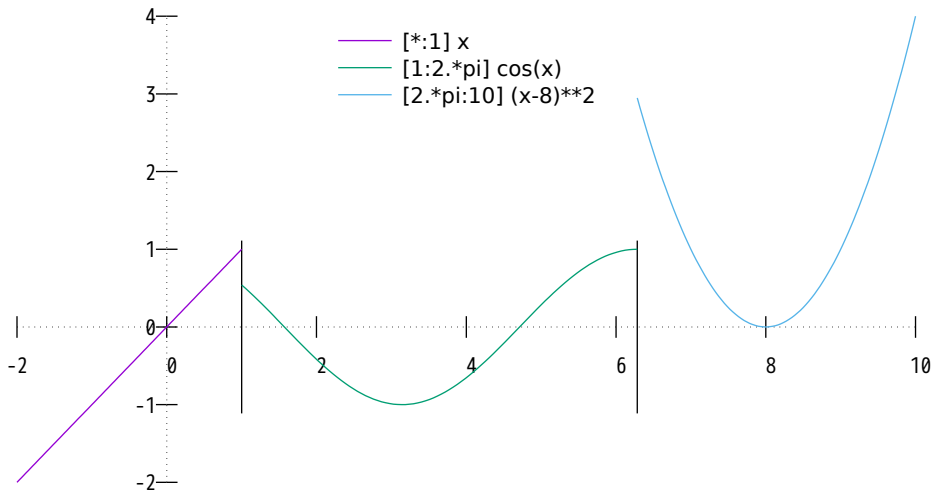

# Piecewise approximation to the Normal Cumulative Distribution Function

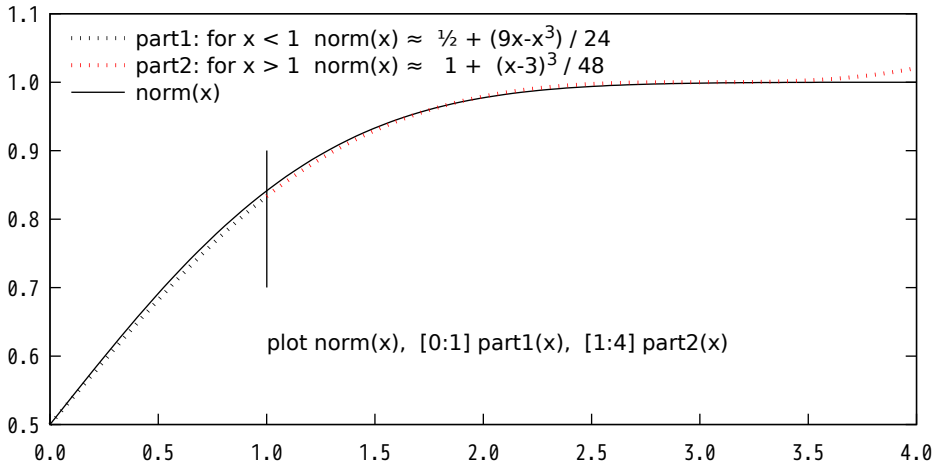

## Piecewise function of one parameter in 3D

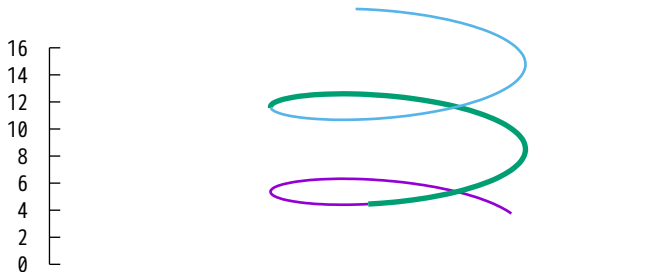

$[h=1:5]$  '+' using  $(\cos(h)):(\sin(h)):(h)$  — purple —  
 $[h=5:10]$  '+' using  $(\cos(h)):(\sin(h)):(h)$  — green —  
 $[h=10:15]$  '+' using  $(\cos(h)):(\sin(h)):(h)$  — blue —

Three circles (with aspect ratio distortion)

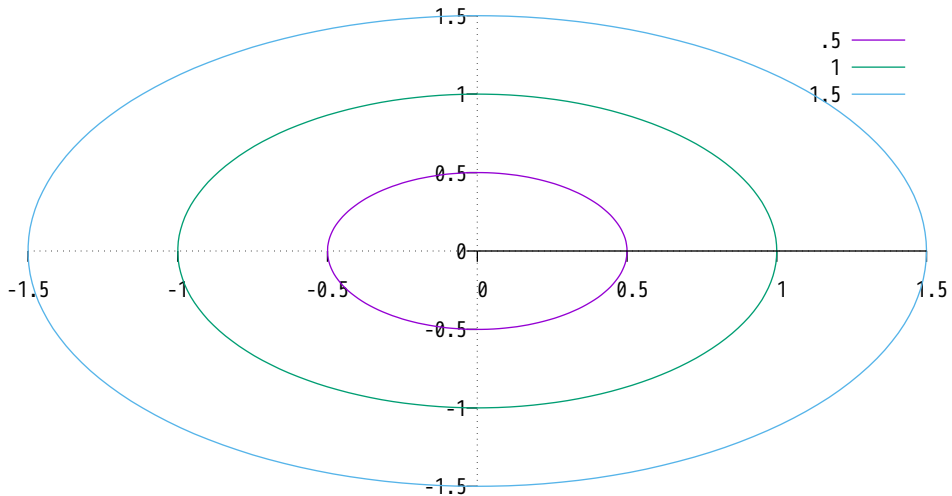

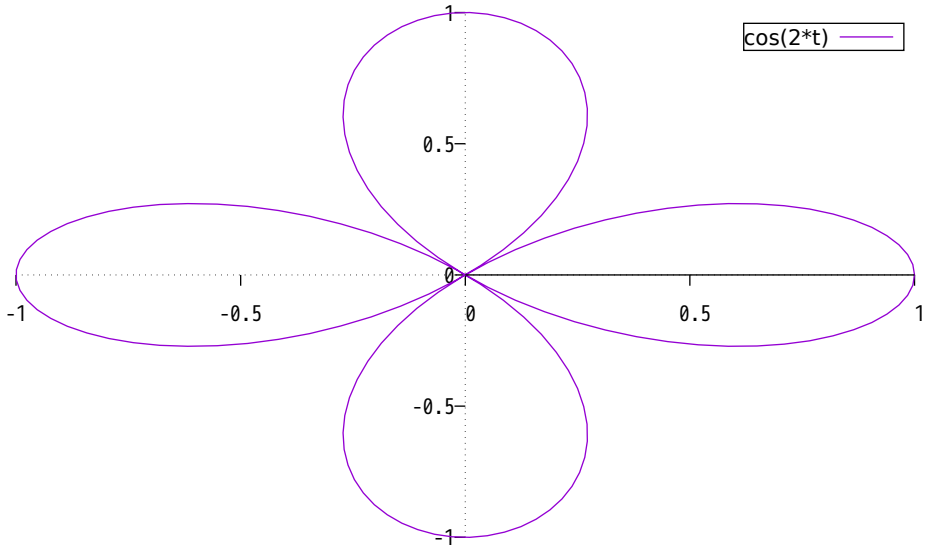

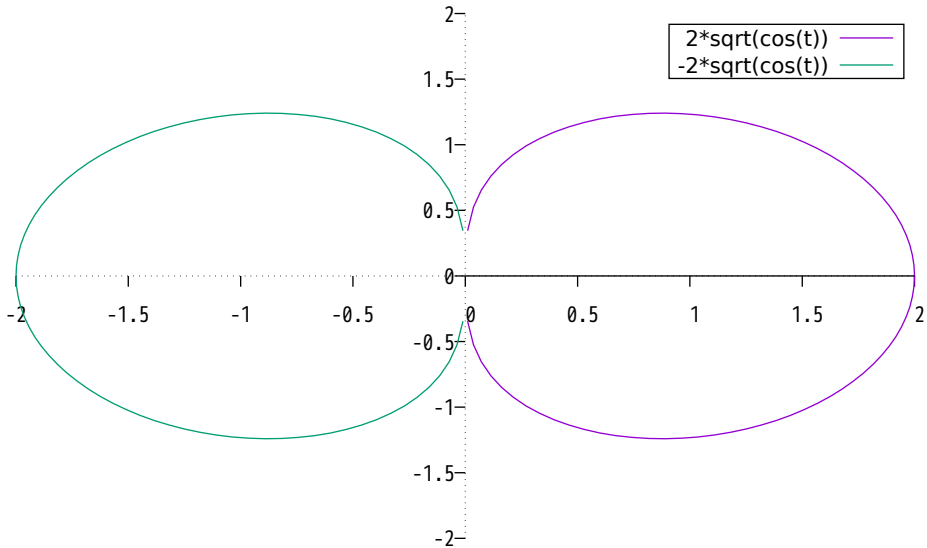

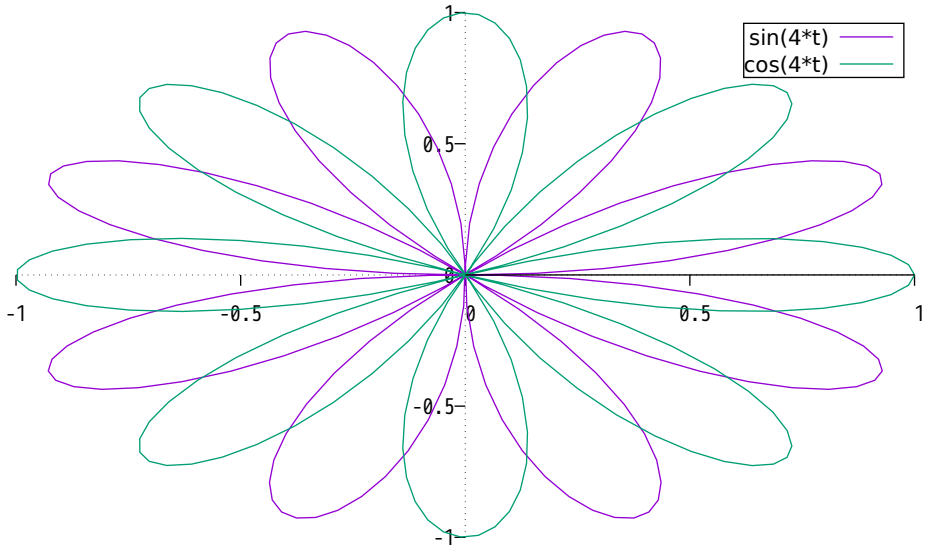

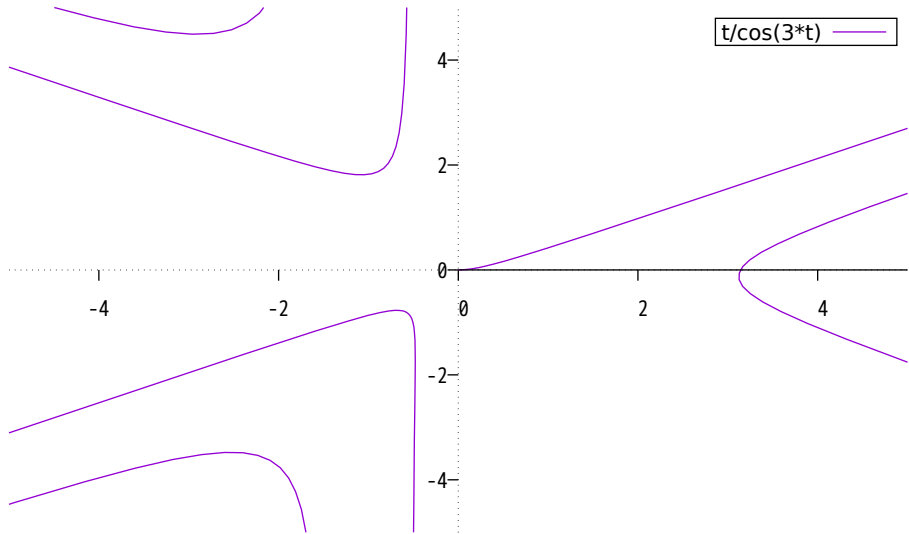



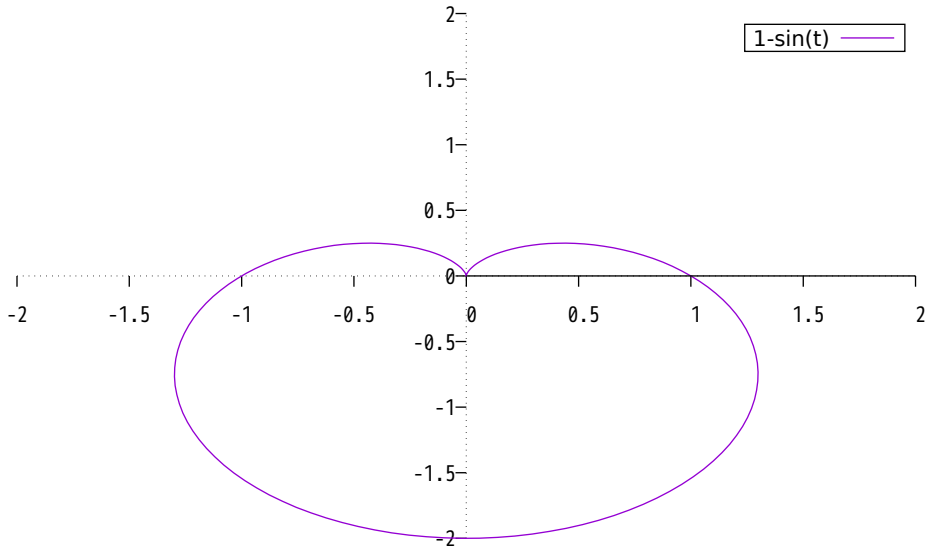

$2*t$  ———

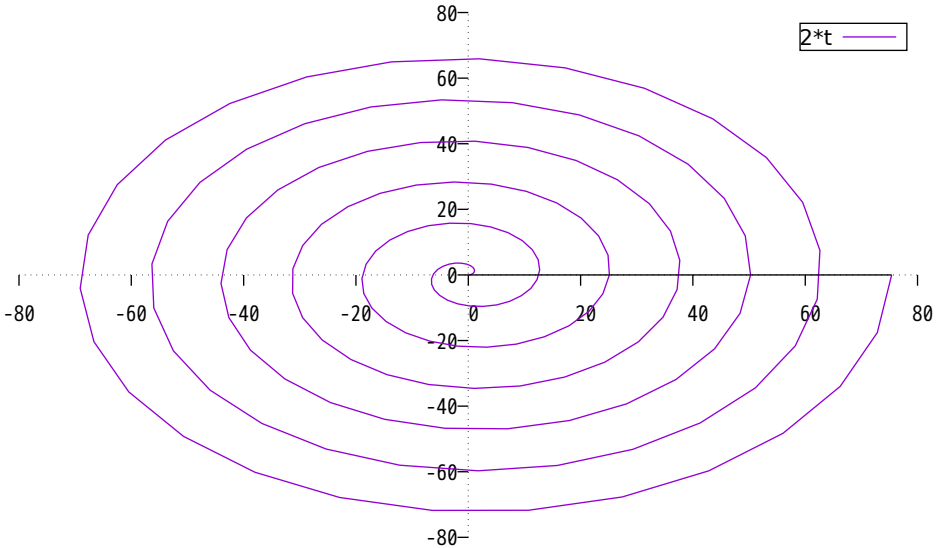

Butterfly

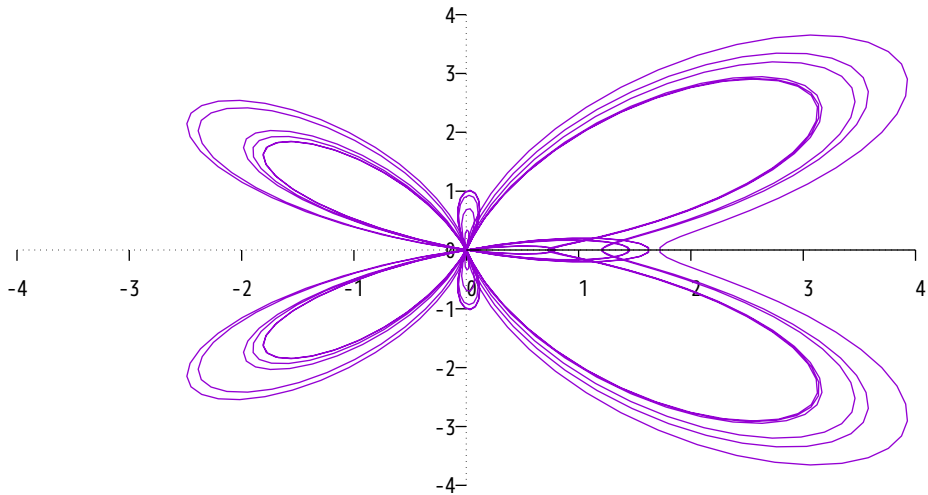

bounding radius 2.5  
 $3. + \sin(t) * \cos(5 * t)$  —

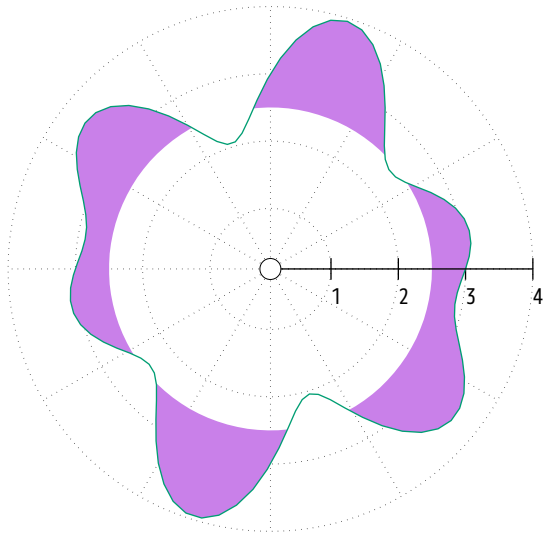

# Primitive Smith Chart

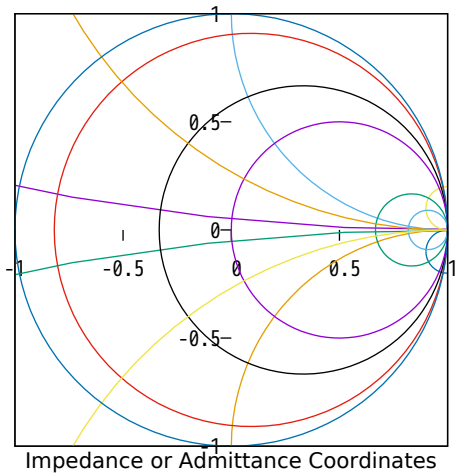

# Antenna Pattern

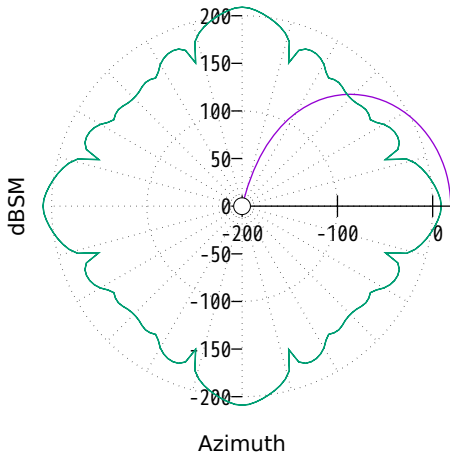

log scale polar axis

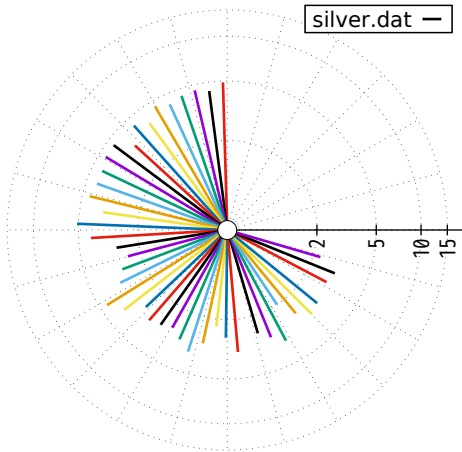

# yerrors in polar mode

polar error bars 

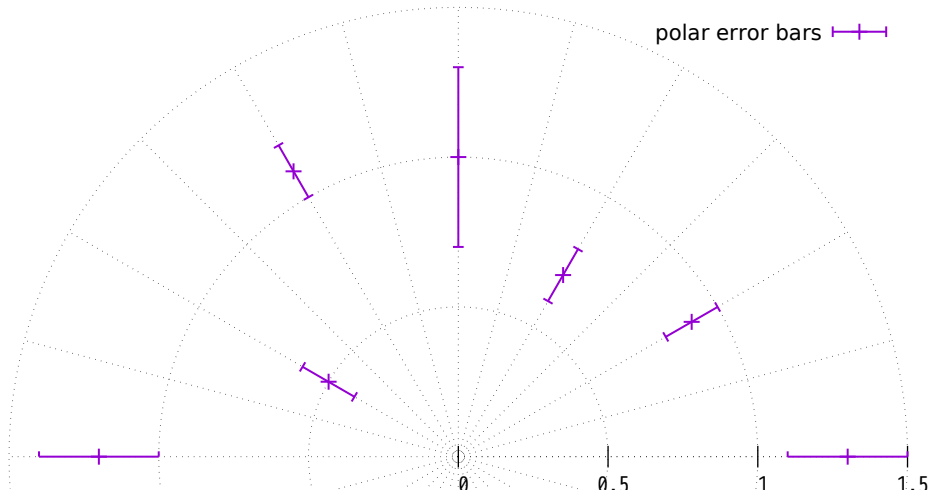



**Solar path at  
Latitude 47.67 N**

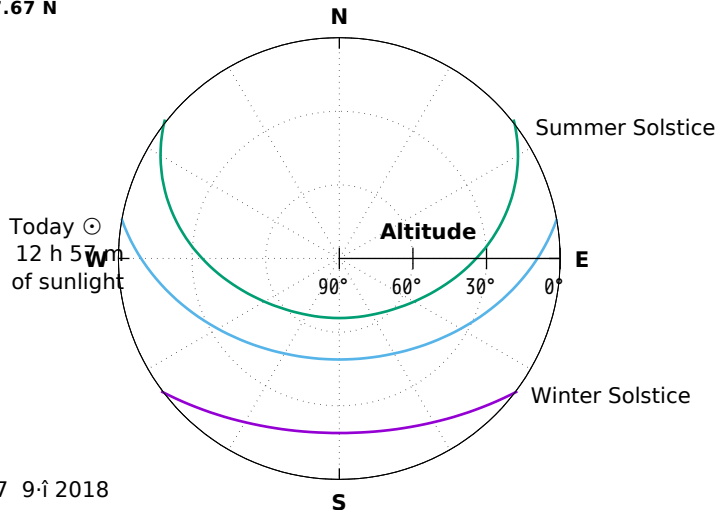

Seattle - 07 9-1 2018

## Angle labels (ttics) for polar plots

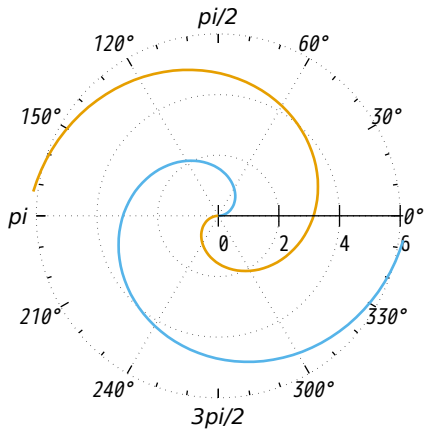

Polar plot with border and rotated labels for ttics

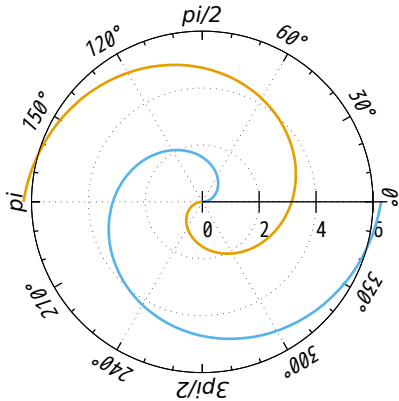

Theta origin at top, increasing clockwise

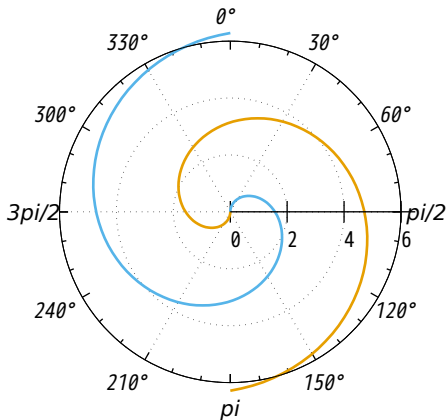

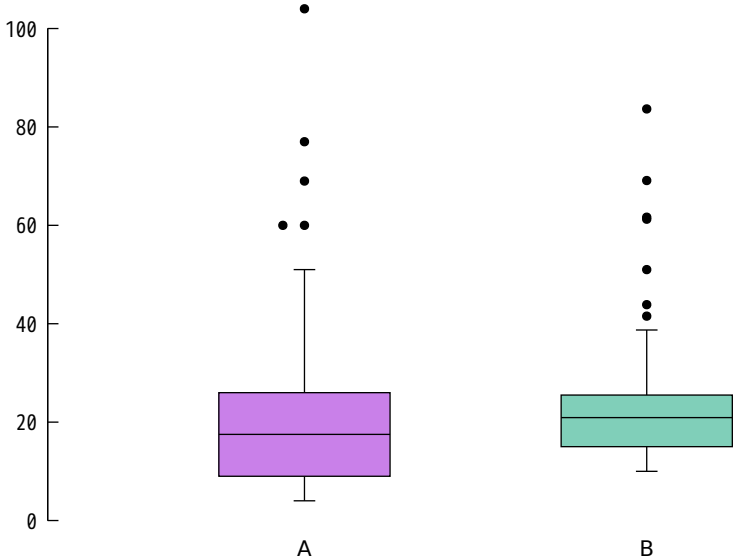

Distribution of energy usage of the continents, grouped by type of energy source

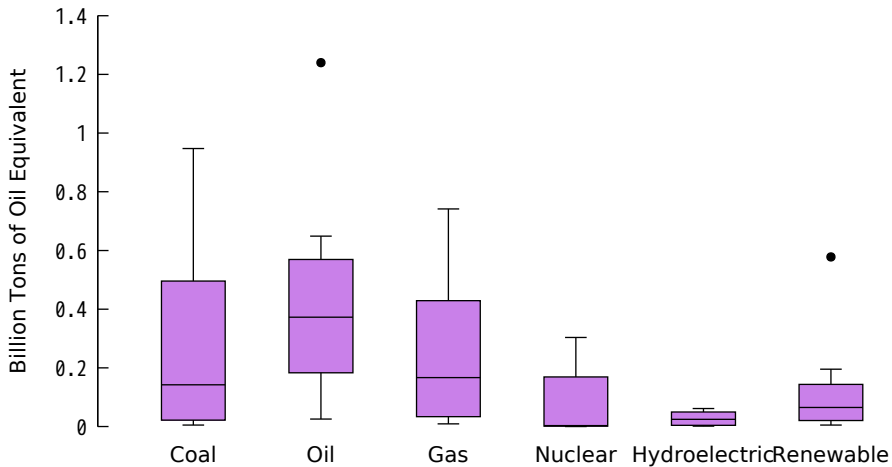

Distribution of energy usage of the continents, grouped by type of energy source, assign individual colors (linetypes) to the factors taken from column 4

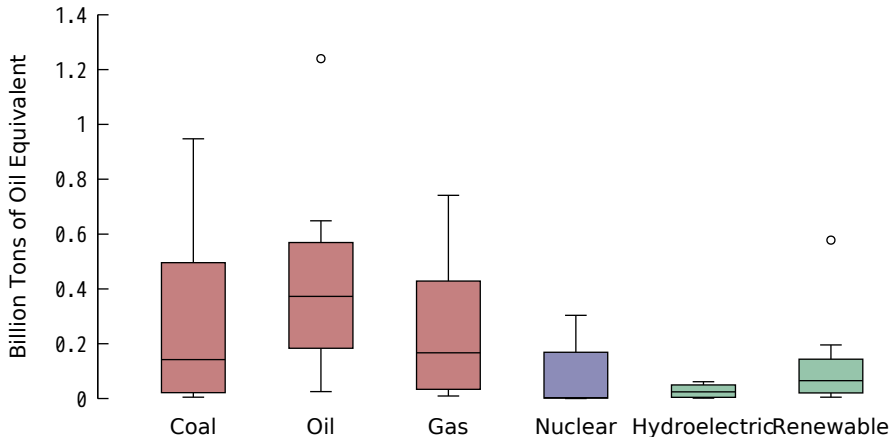

Distribution of energy usage of the continents, sorted by name of energy source

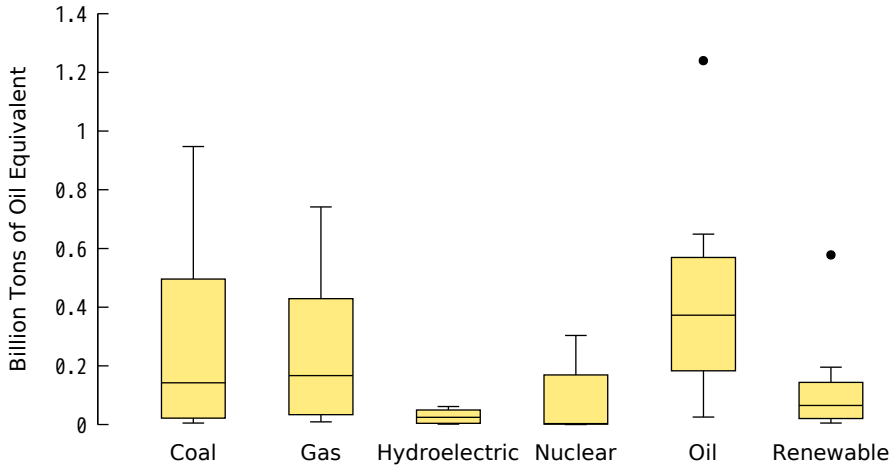



Distribution of energy usage explicitly ordered by name of energy source

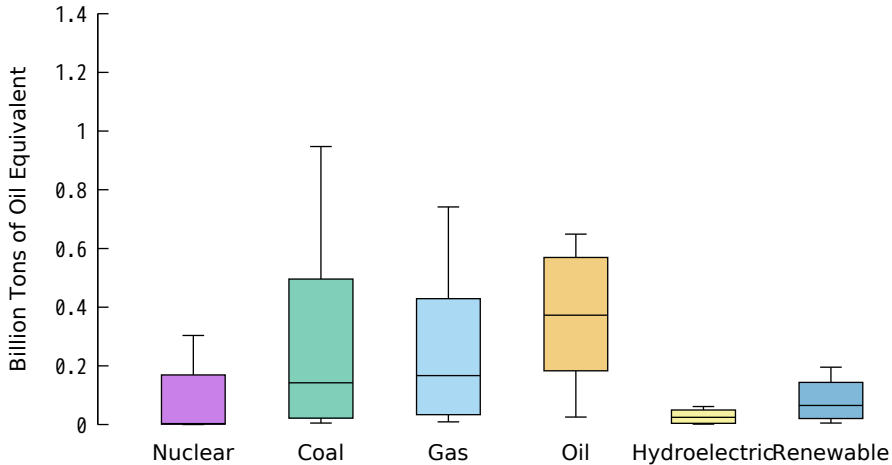

no jitter

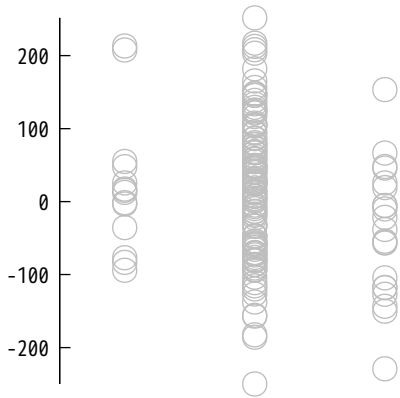

A

B

C

jitter

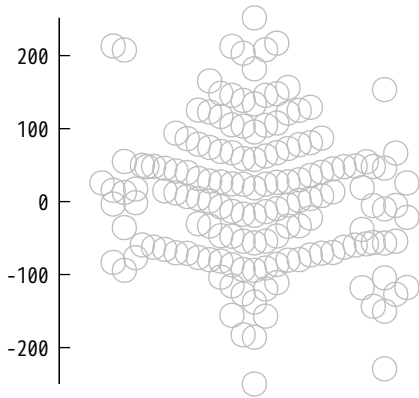

A

B

C

vertical overlap criterion

jitter overlap 0.5

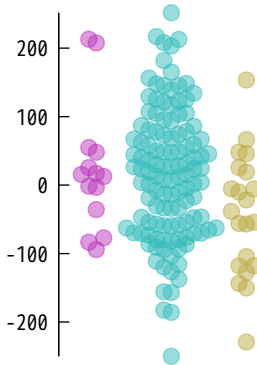

A

B

C

jitter overlap 1.0

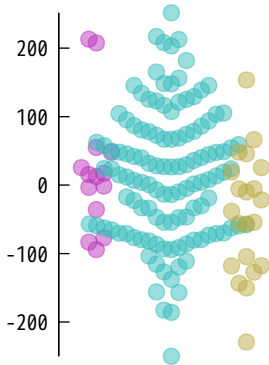

A

B

C

jitter overlap 1.5

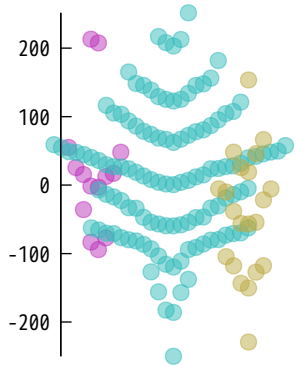

A

B

C

spread parameter scales the horizontal jitter

jitter spread 0.4

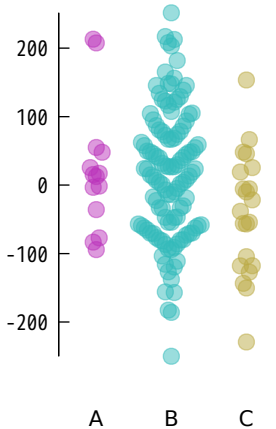

jitter spread 0.7

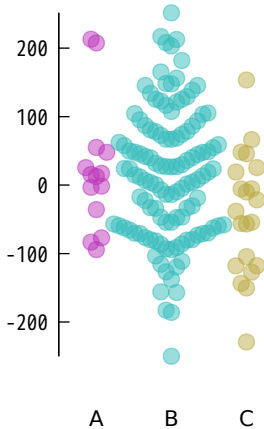

jitter spread 1.0

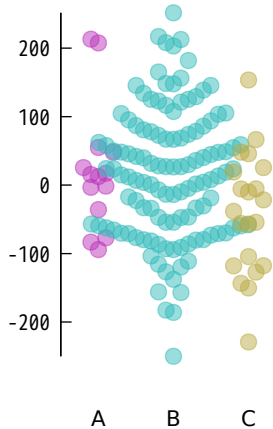

# Plot appearance is also affected by point size

pointsize 0.5

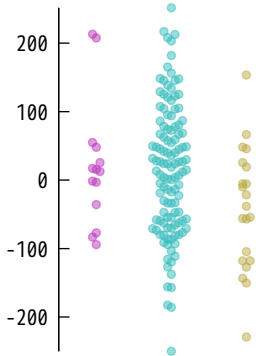

A

B

C

pointsize 1.0

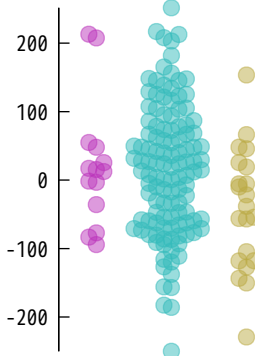

A

B

C

pointsize 2.0

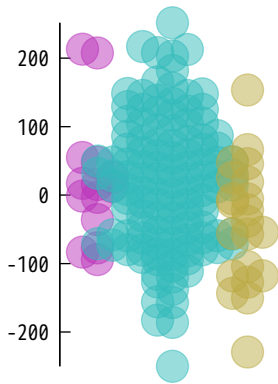

A

B

C

# Jitter style options

## swarm (default)

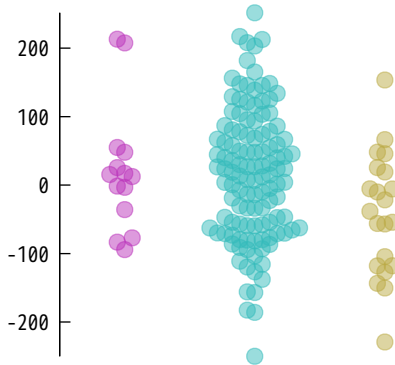

A

B

C

## square

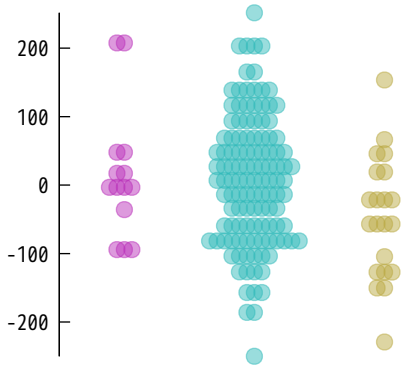

A

B

C

# Jitter style options

## no wrap

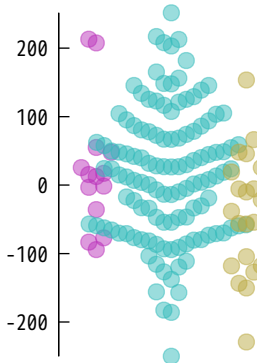

A

B

C

## wrap 5

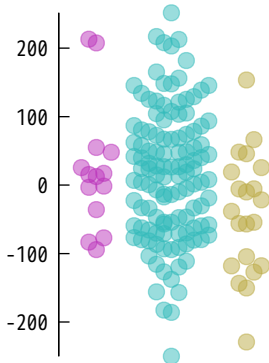

A

B

C

## wrap 3

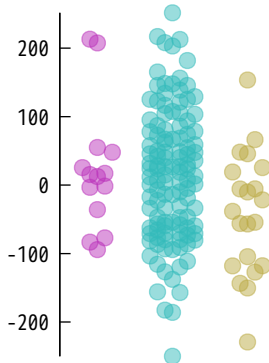

A

B

C

Jitter style option  
vertical

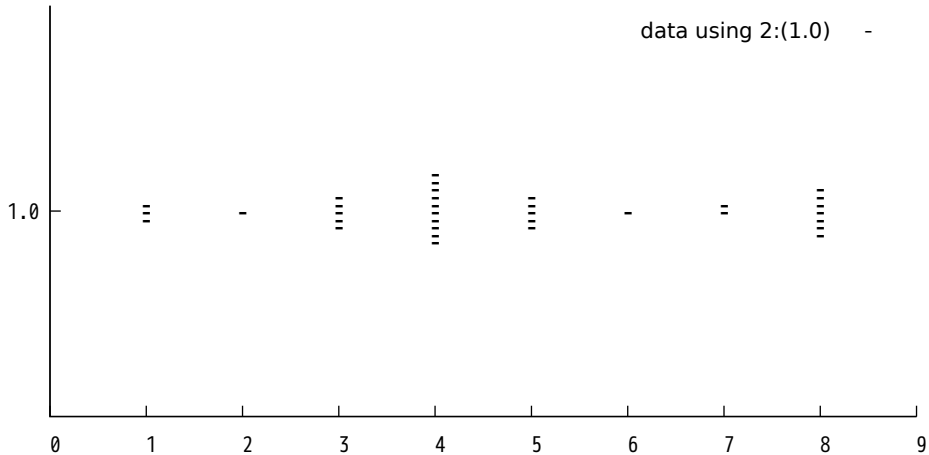



swarm jitter with a large number of points  
approximates a violin plot

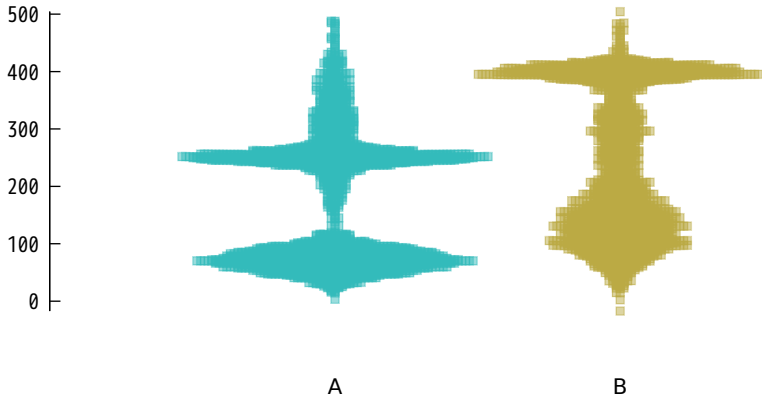

# Gaussian random jitter

500  
400  
300  
200  
100  
0

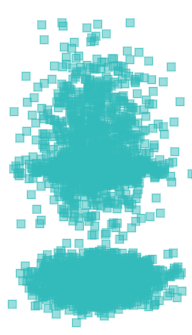

A

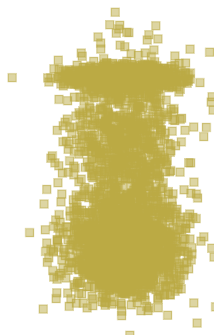

B

Same data - kernel density

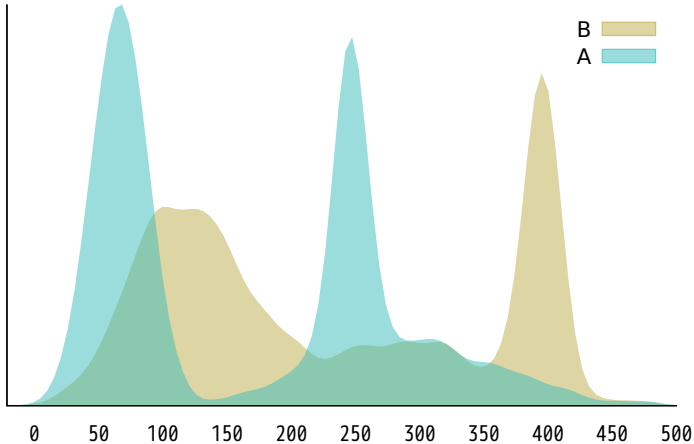

kdensity mirrored sideways to give a violin plot

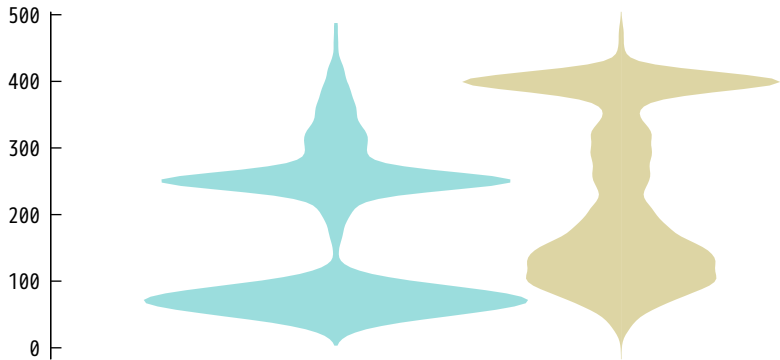

## Superimposed violin plot and box plot

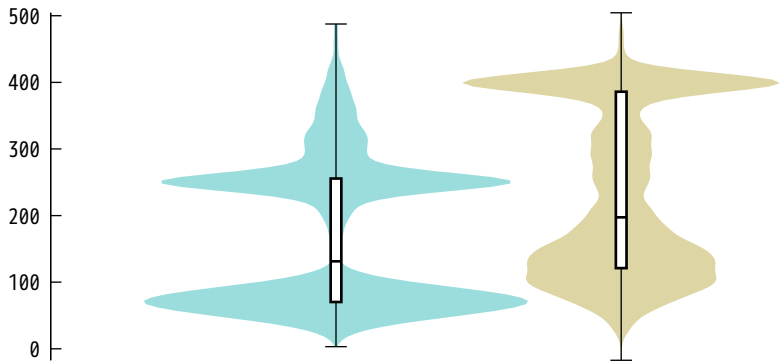

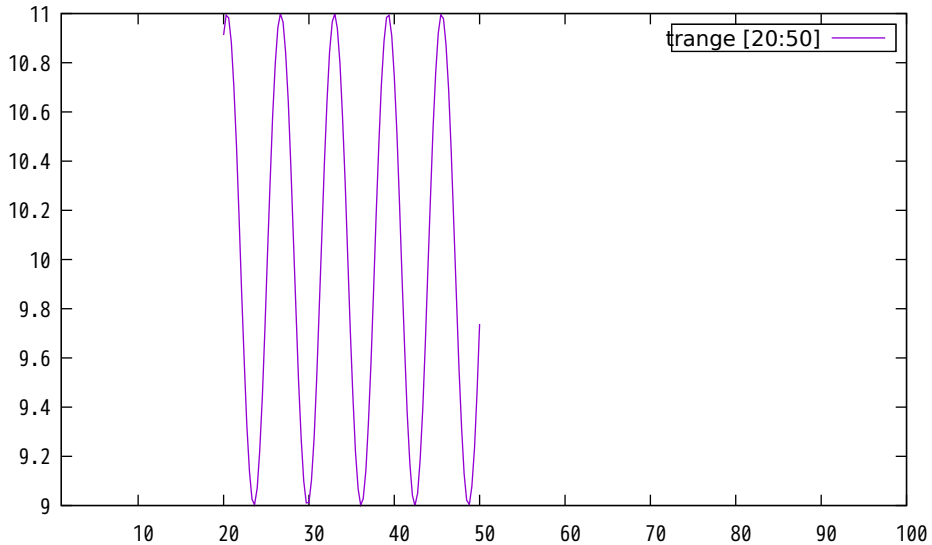

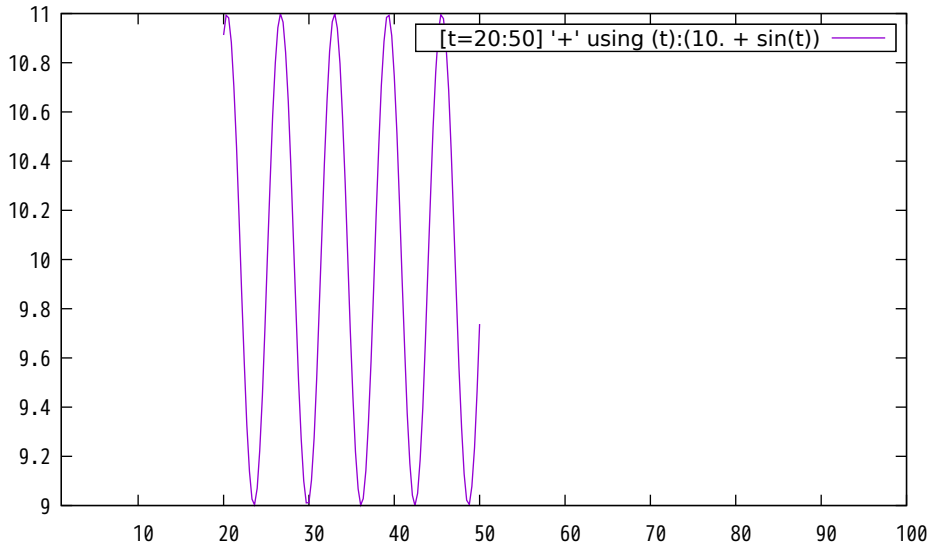

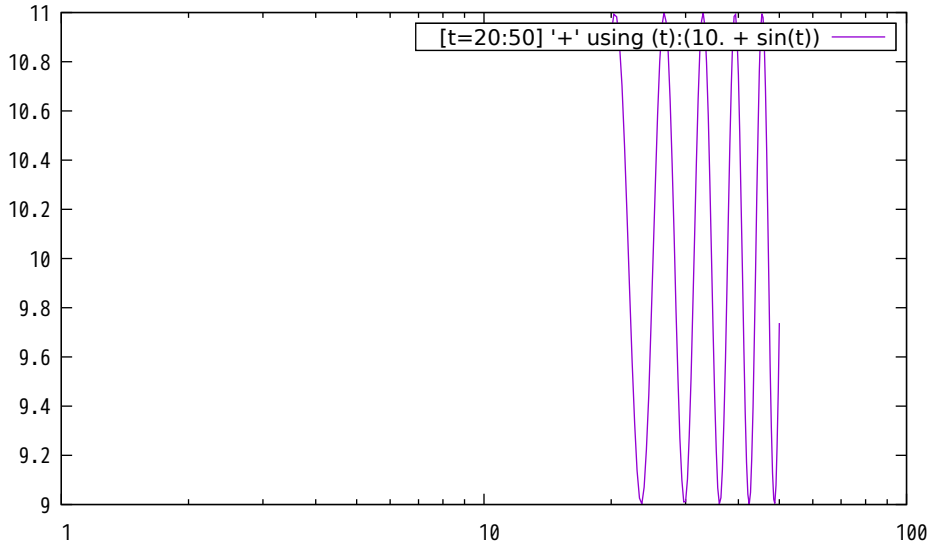



'++' using 1:2:(\$1\*\$2) ———

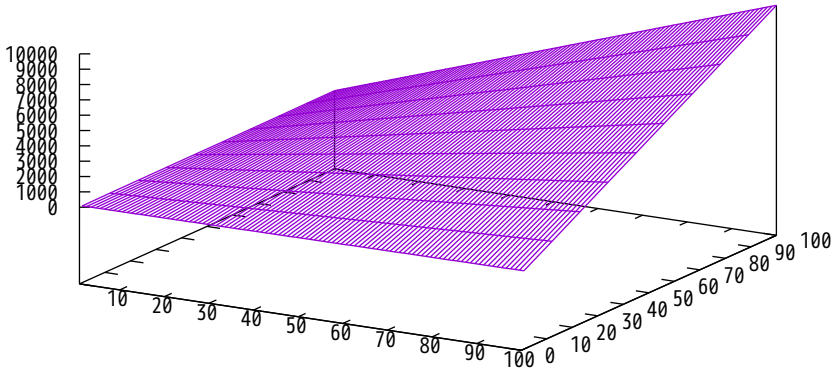

'++' using 1:2:(\$1\*\$2) ———

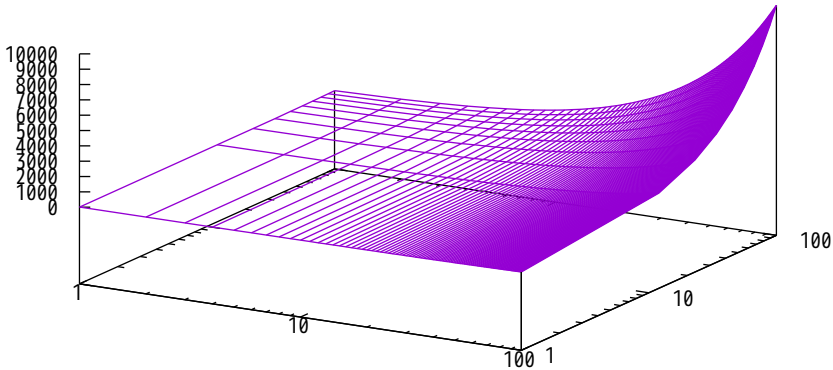

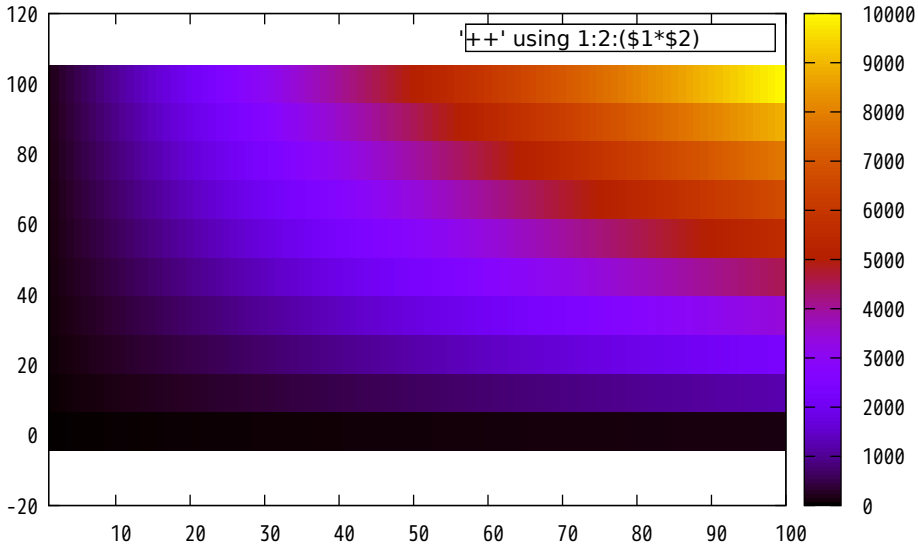

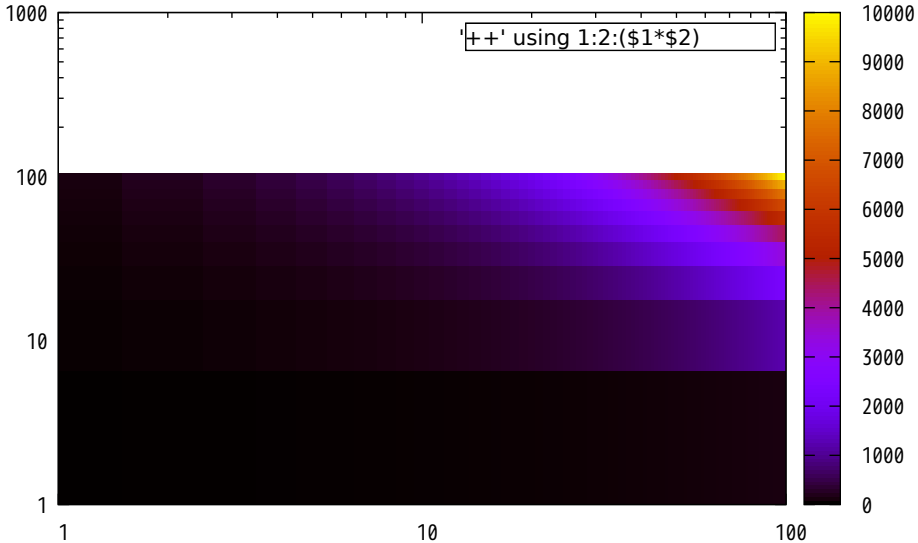

Piecewise function sampling along linear x

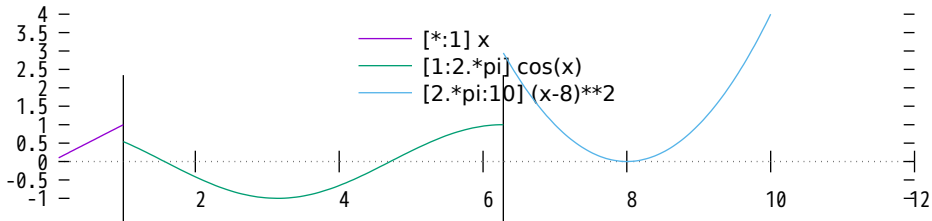
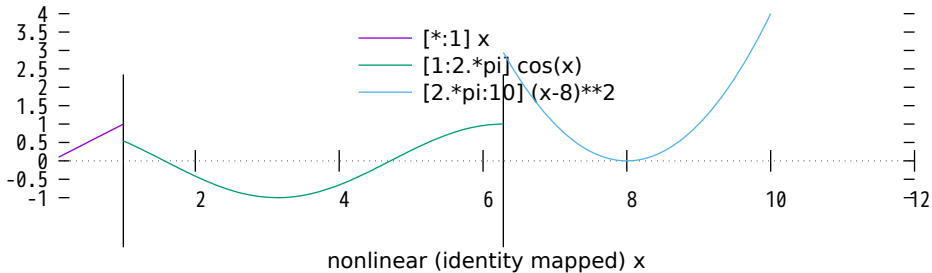

### 3D sampling range distinct from plot x/y range

'++' using  $1:2:(1*25.*\sin(2/10))$  — purple  
[u=30:70][v=0:50] '++' using  $1:2:(u*v)$  — light blue  
[u=40:80][v=30:60] '++' using  $(u):(v):(u*\sqrt{v})$  — yellow  
[u=1:100][v=500:1000] '++' using  $(90):(u):(v)$  — dark blue

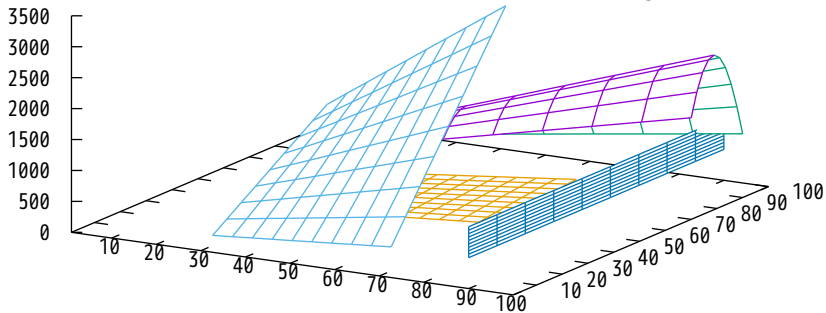

3D custom sampling on u and v using pseudofile '++'

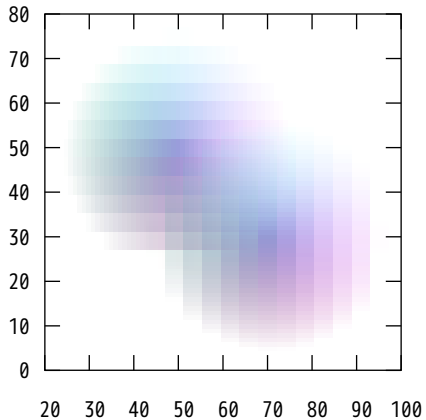

2D custom sampling on u and v using pseudofile '++'

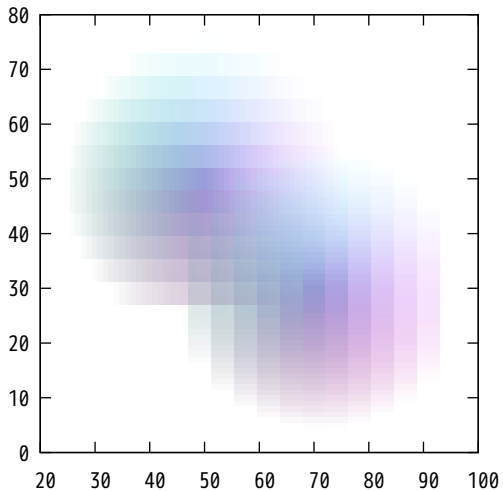



# Sampling one dimension in 2D

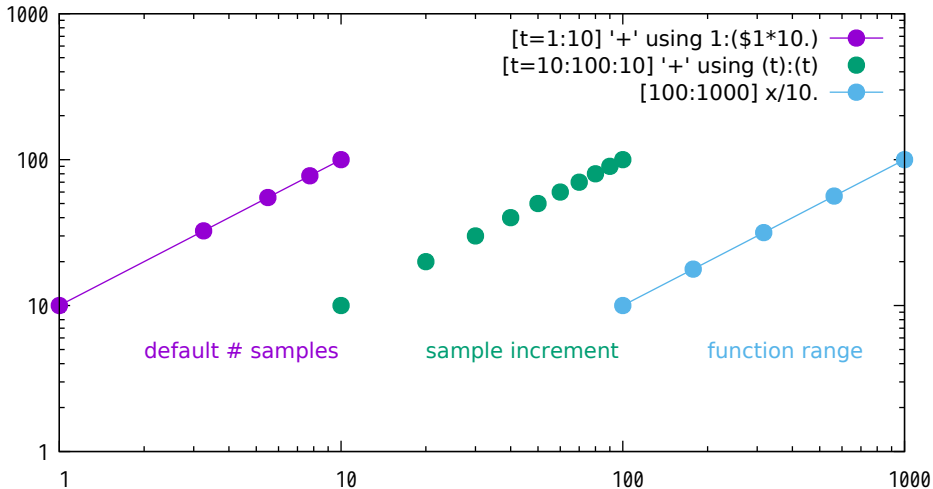

# Sampling one dimension in 3D

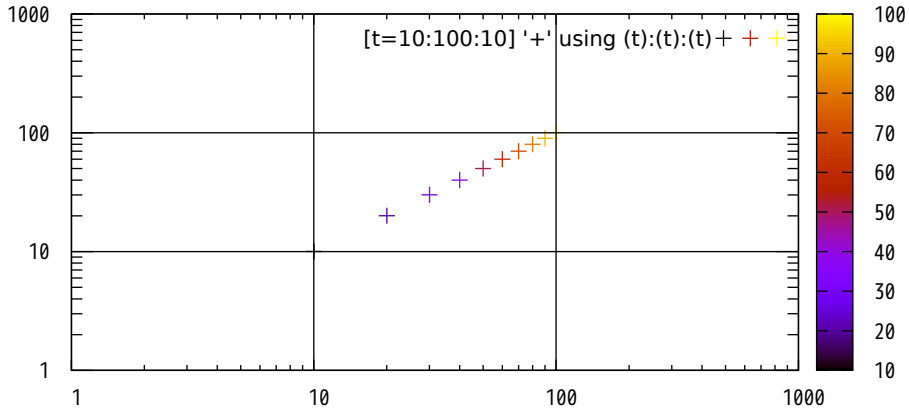

Second Order System Transfer Function - Magnitude

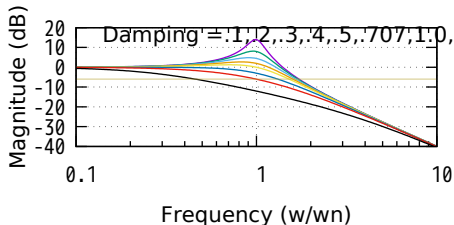

Second Order System - Unit Step Response

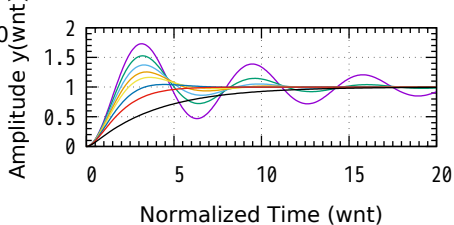

Second Order System Transfer Function - Phase

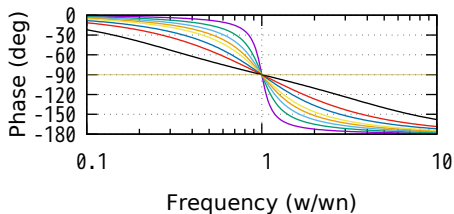

Second Order System - Unit Impulse Response

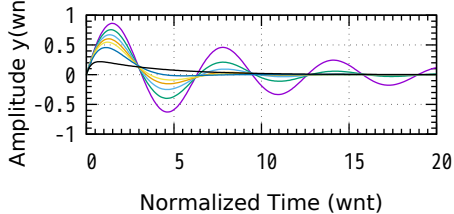

# Multiplot layout 3, 1

Plot 1

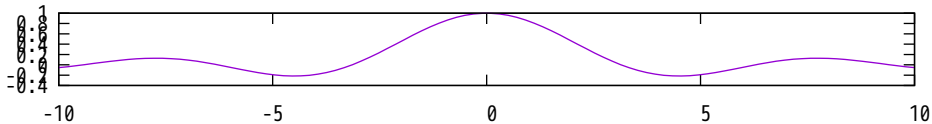

Plot 2

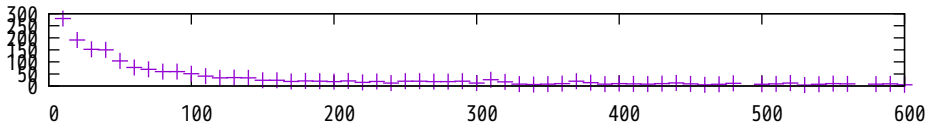

Plot 3

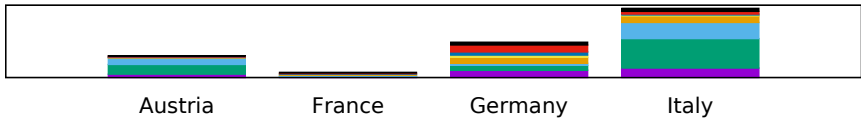

# Multiplot layout 1, 3

Plot 1

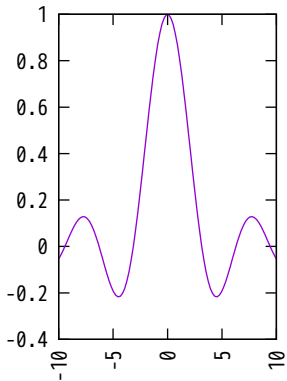

Plot 2

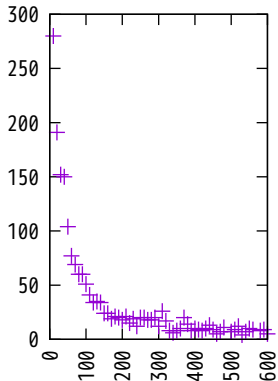

Plot 3

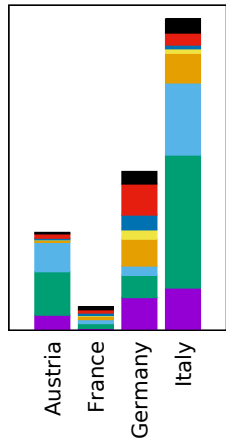

Same plot with a multi-line title  
showing adjustment of plot area to accommodate it  
Also note 'reset' command between plots 2 and 3

Plot 1

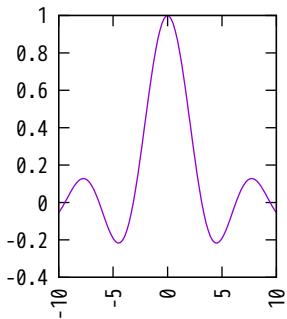

Plot 2

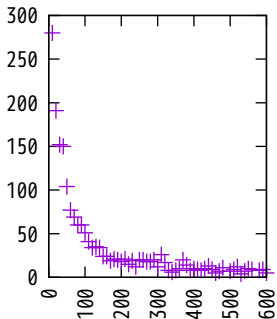

Plot 3

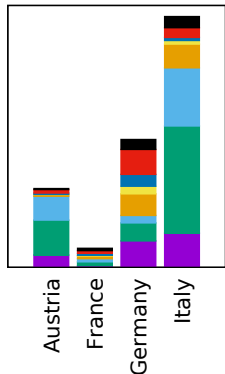

## Auto-layout of stacked plots

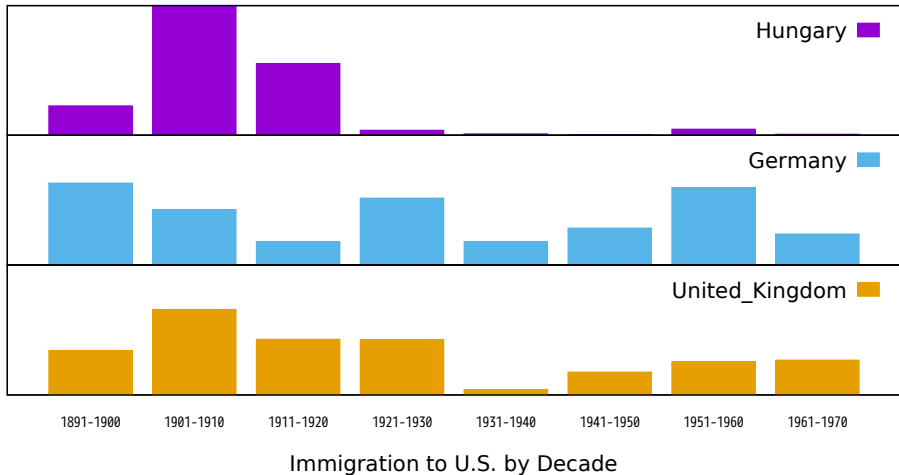

## Expanding one of the plots to use additional space

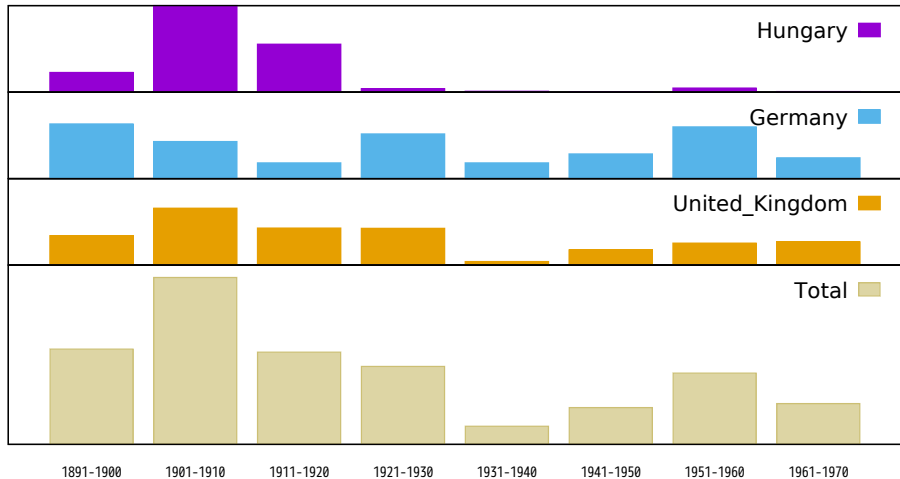

Immigration to U.S. by Decade



# Multiplot with explicit page margins

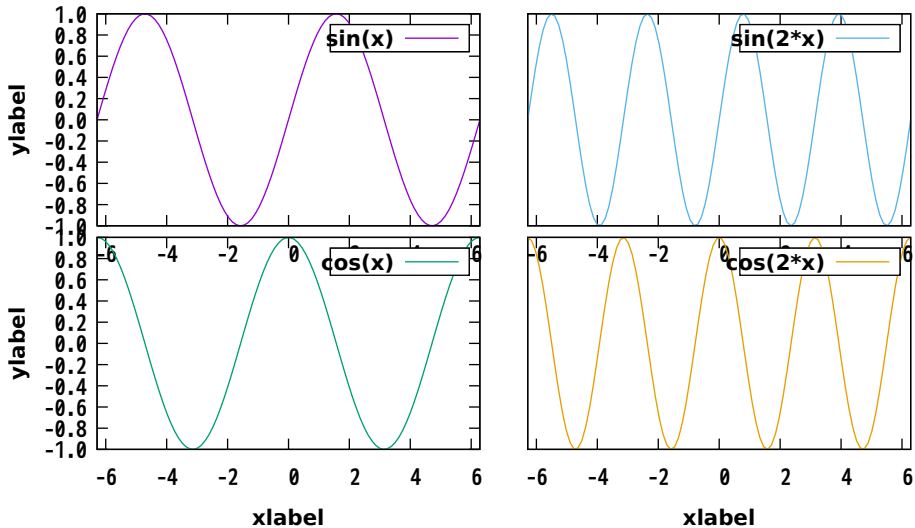

### 3D surface from a grid (matrix) of Z values

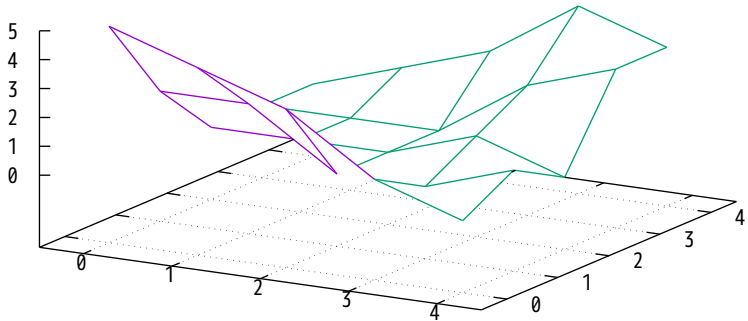

# 3D surface from a function

$x*y$  —

This is the surface boundary

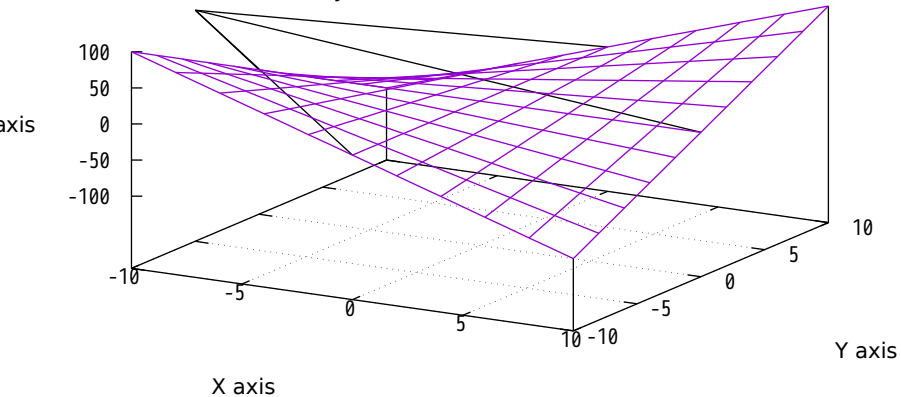

3D surface from a function

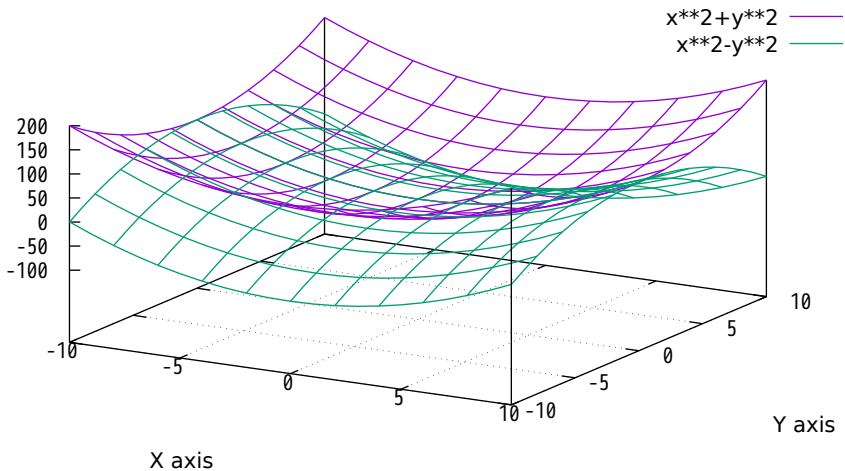

3D surface from a function

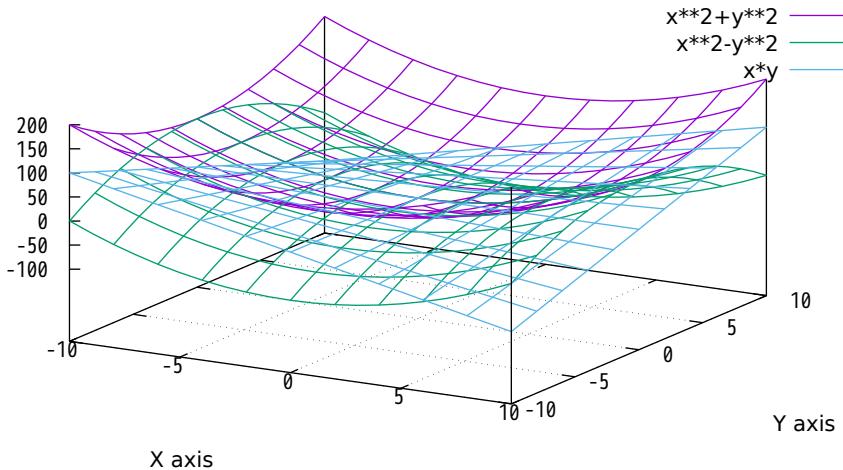

### 3D surface from a function

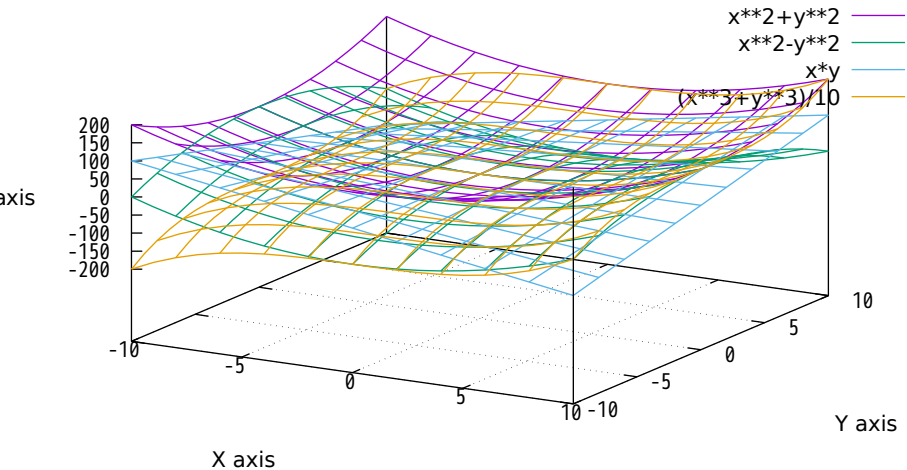

3D gnuplot demo ( ticslevel = 0.0 )

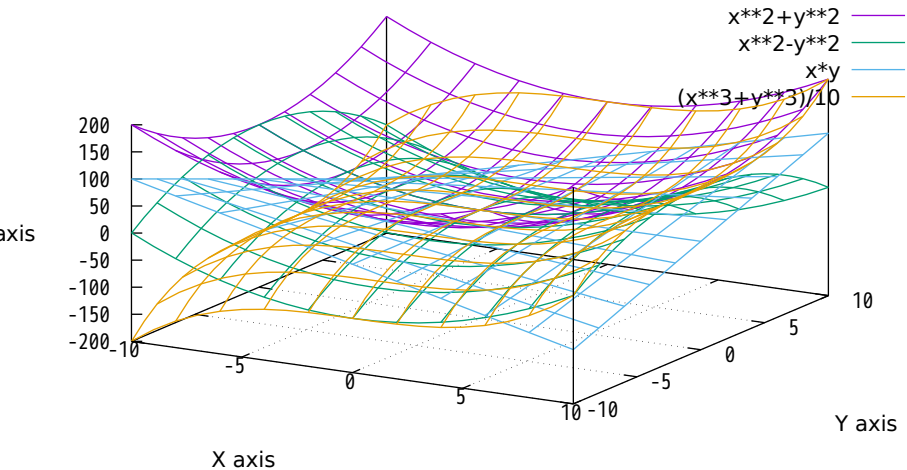

### 3D gnuplot demo ( ticslevel = 2.0 )

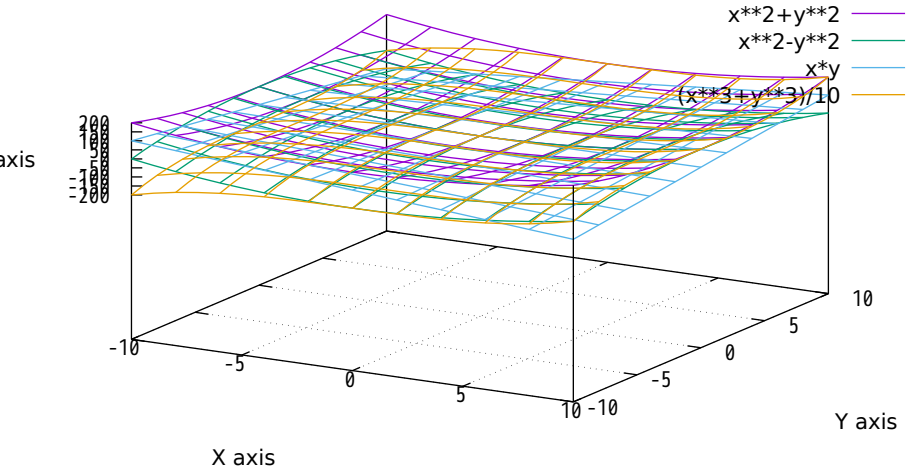



3D gnuplot demo ( ticslevel = 0.5 )

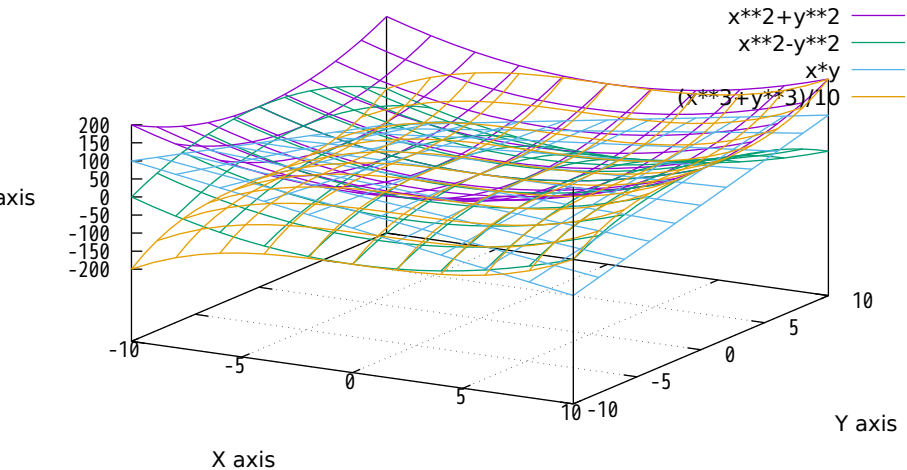

# 3D gnuplot demo

$x*y$  +

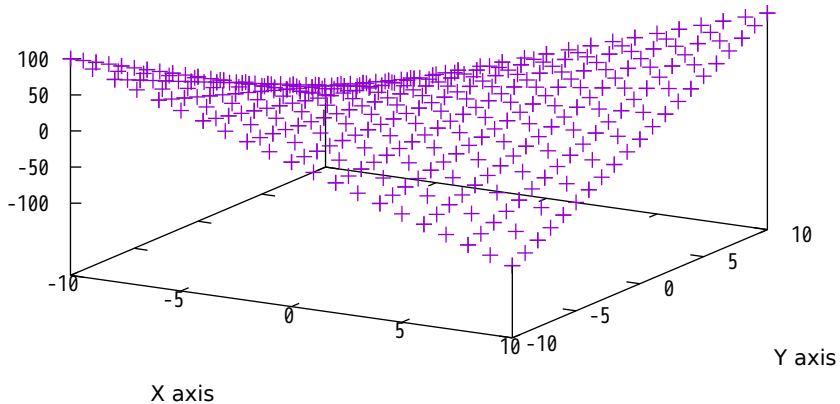

# Surfaces with no grid or tics

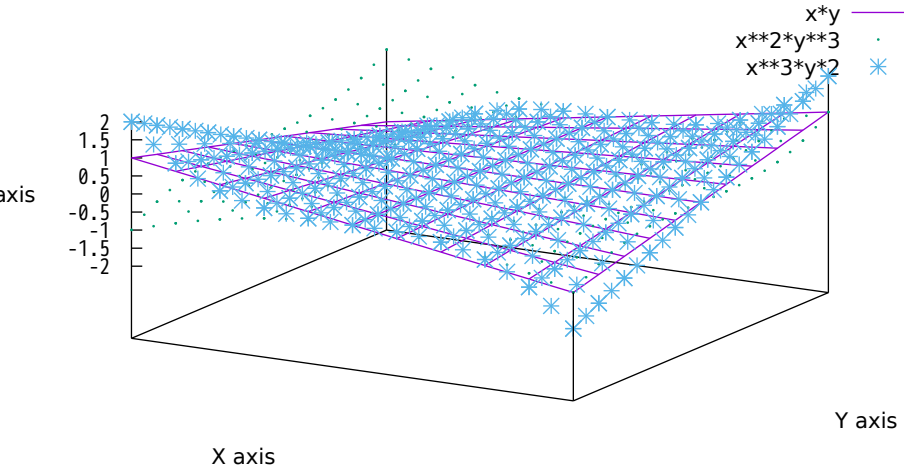

Surfaces with z log scale

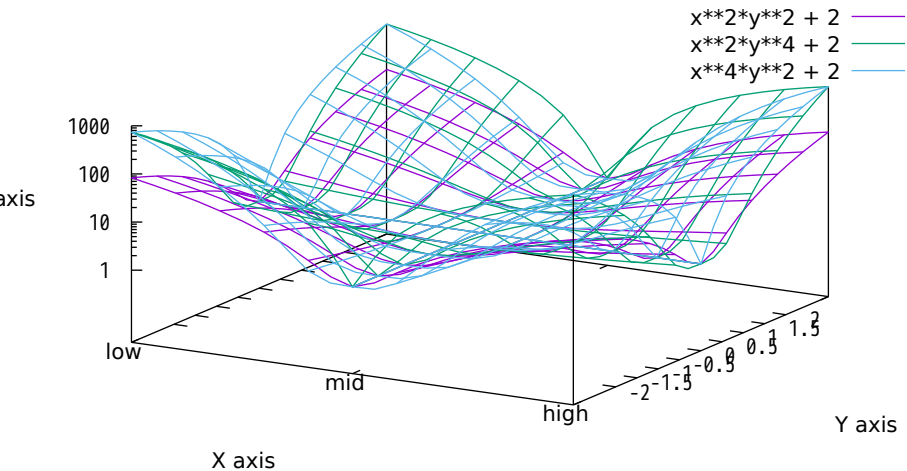

### 3D gnuplot demo

$$u*v / (u**2 + v**2 + 0.1) \text{ ———}$$

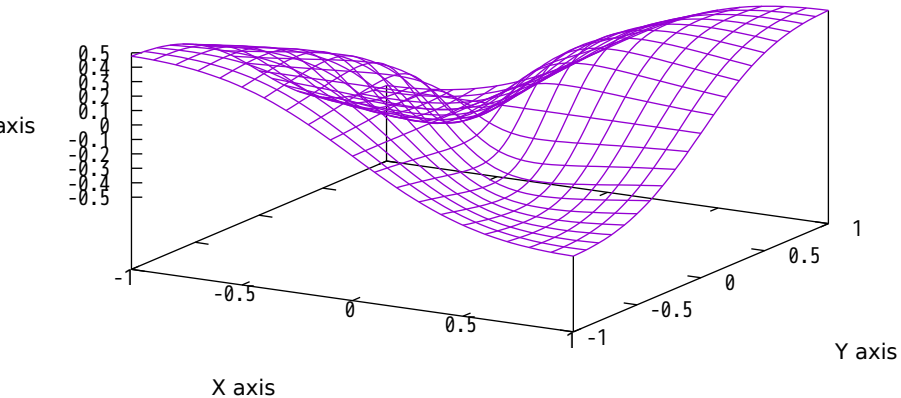

### 3D gnuplot demo

$\sin(x) * \cos(y)$  —

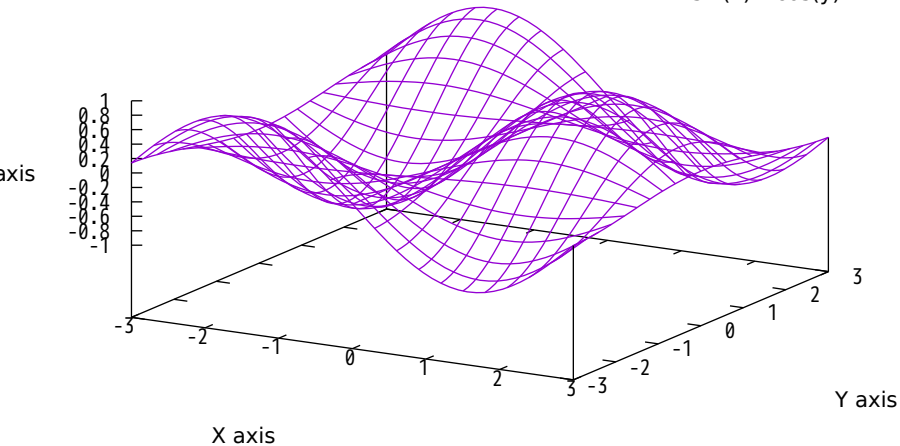

### 3D gnuplot demo

$\sin(x) * \cos(y)$  —

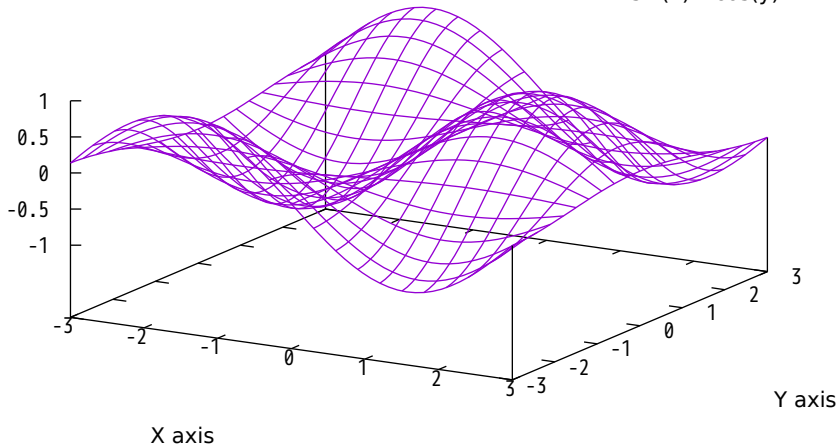

# Sinc function

$\text{sinc}(u,v)$  —

This is equal to 1

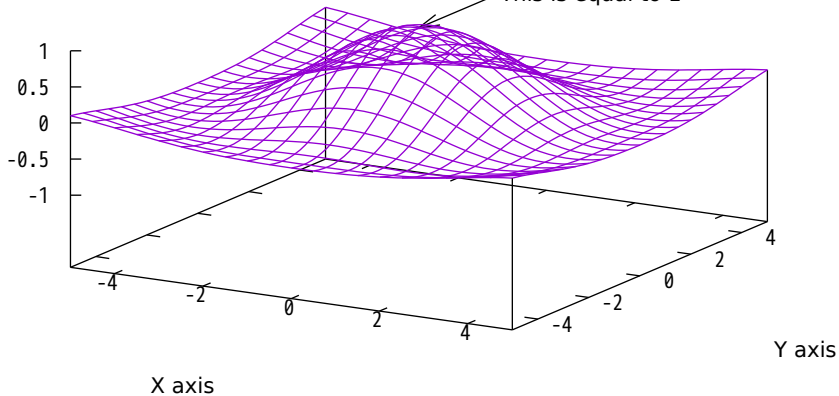



# Sinc function

$\text{sinc}(u,v)$  —

This is equal to 1

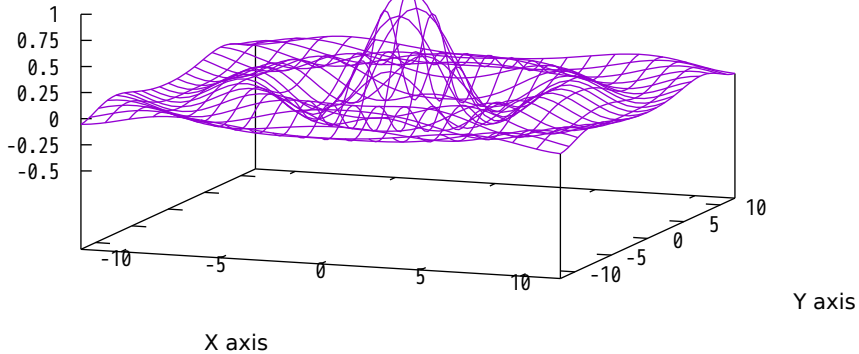

fence plot constructed with separate parametric surfaces

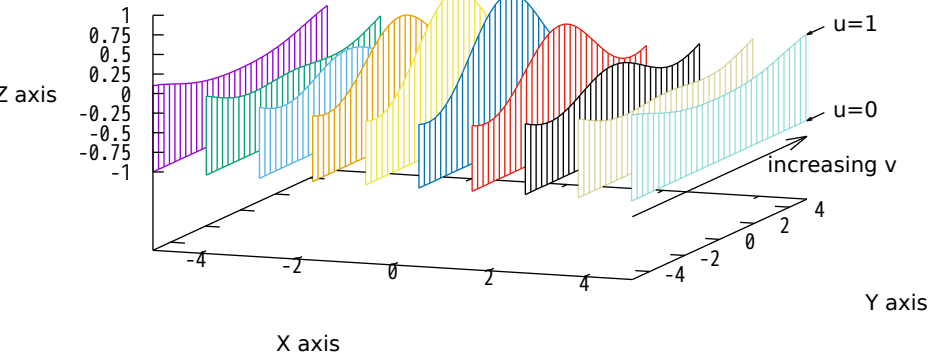

"fence plot" using single parametric surface with undefined points

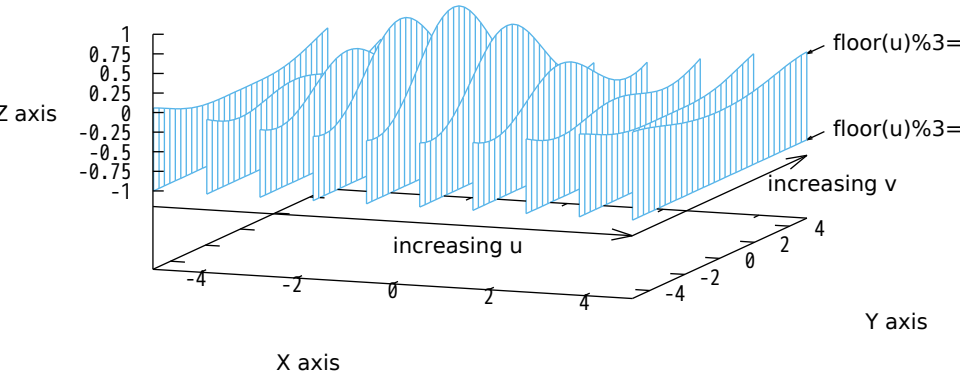

This has logarithmic scale

$$x^{**2}+y^{**2}$$

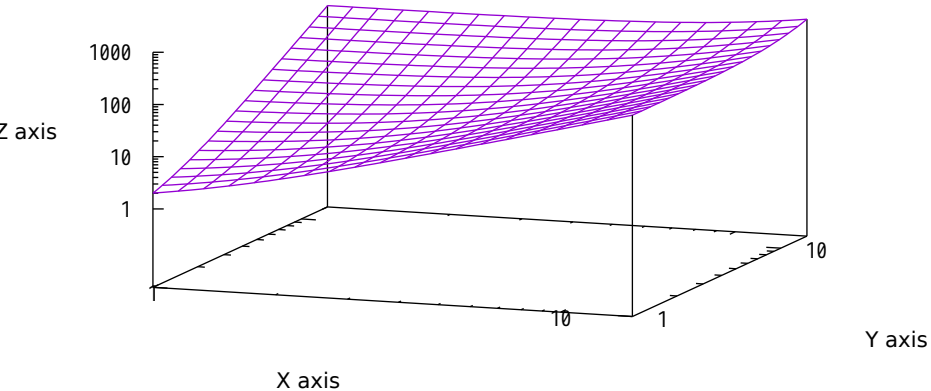

# Data grid plotting

"glass.dat" —

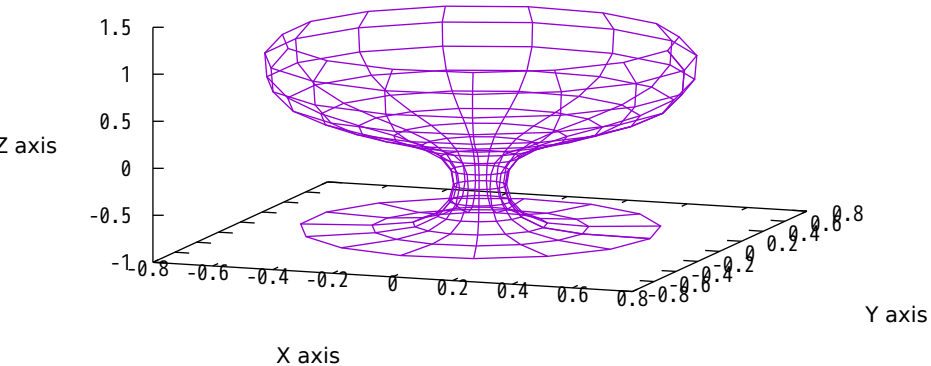

# Data grid plotting

"glass.dat" using 3:2:1 

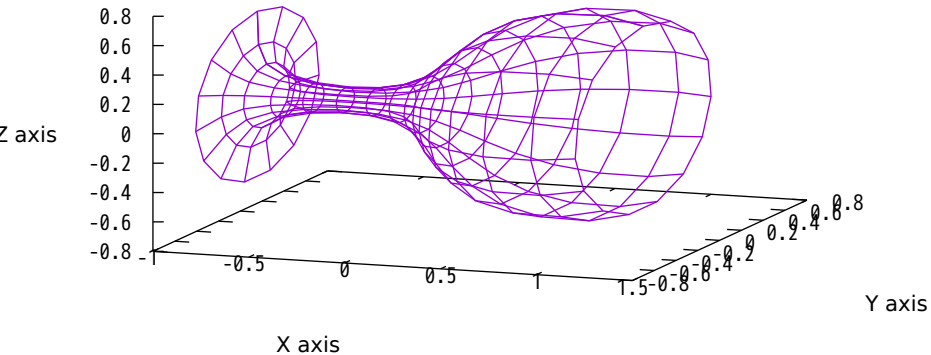

# Data grid plotting

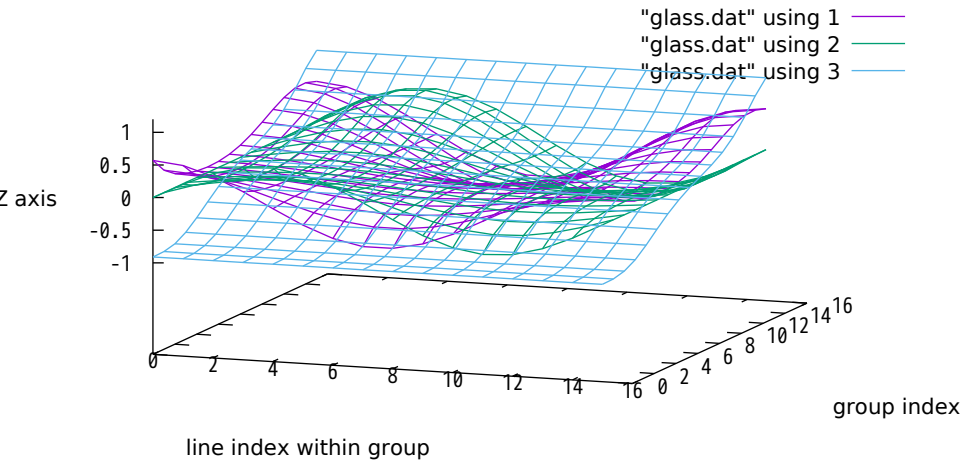

plot of part of a data file

'glass.dat' every 2::0::12 

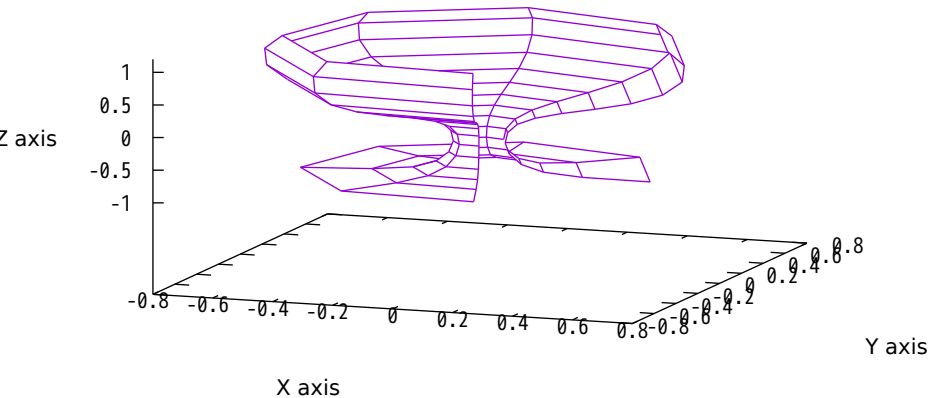



plot with "set pm3d" (implemented with some terminals)

'glass.dat' every 2::0::12 —

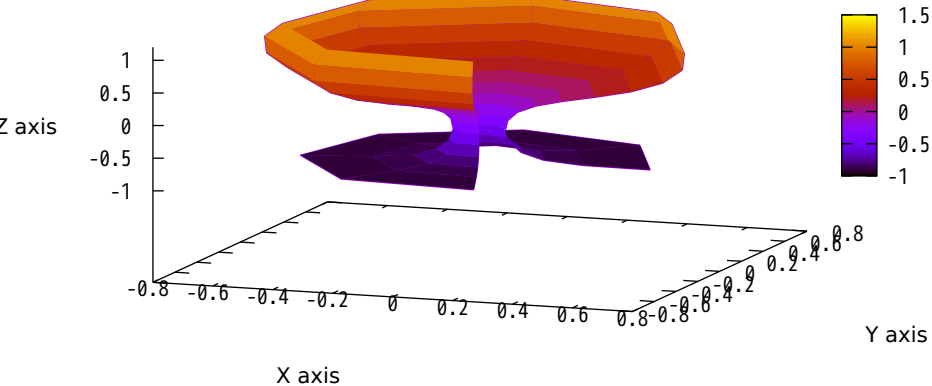

# Test of spherical coordinates

"glass.dat" —

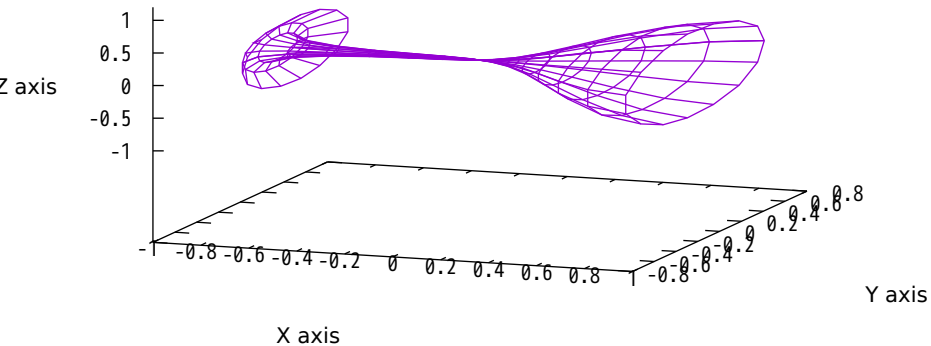

# Mandelbrot function

`mand({0,0},compl(x,y),30)` —

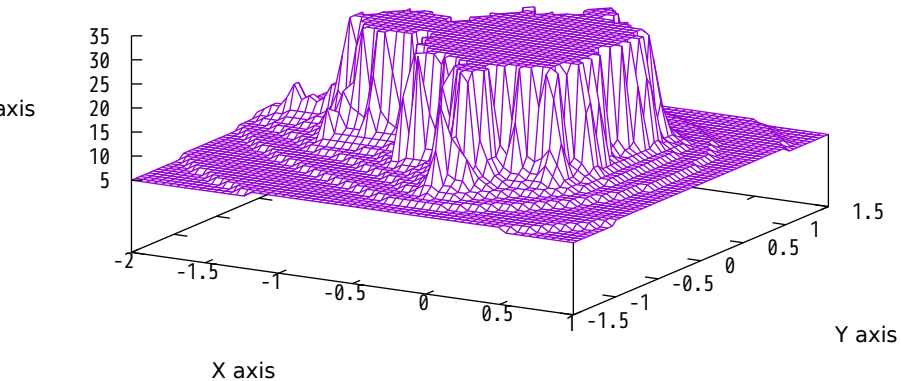

# Demo of specifying discrete contour levels - default contours

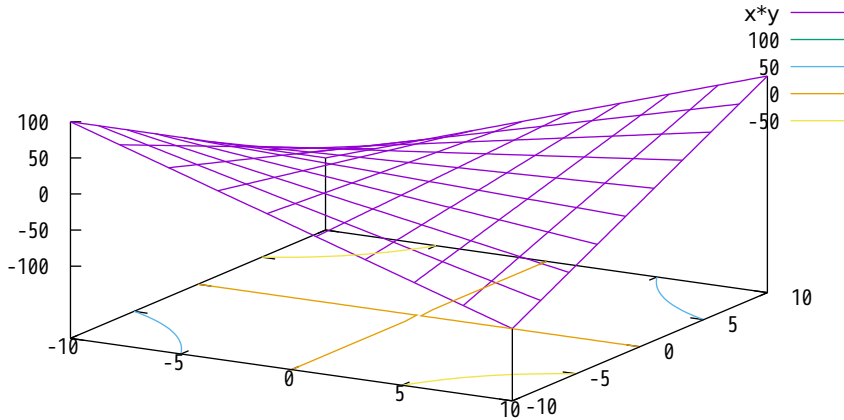

3 discrete contours at 0 15 75

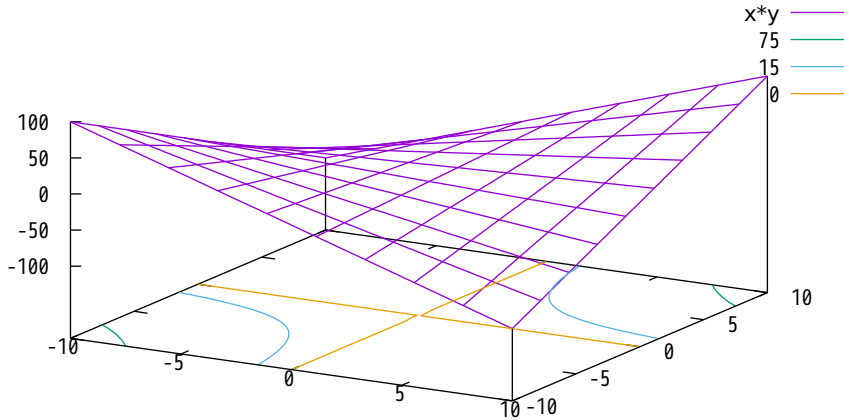

9 incremental contours starting at -20, stepping by 5

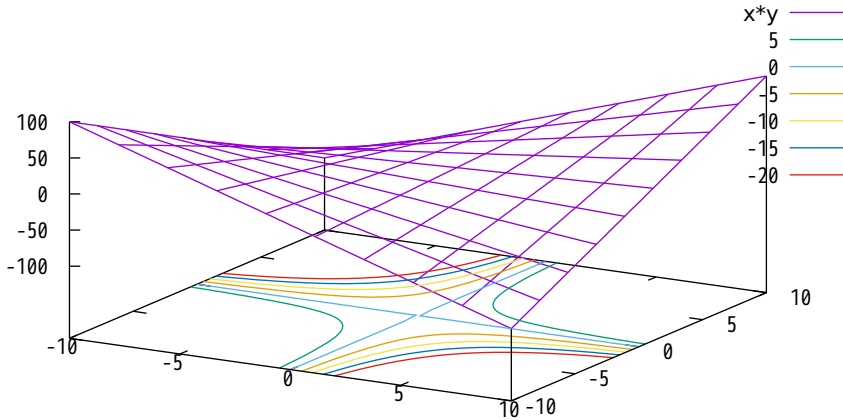

## Hidden line removal of explicit surfaces

$$1 / (x*x + y*y + 1) \quad \text{—}$$

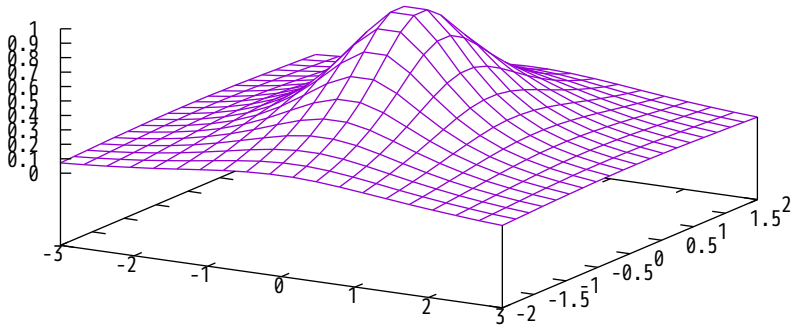

## Hidden line removal of explicit surfaces

$$x*y / (x**2 + y**2 + 0.1) \quad \text{—}$$

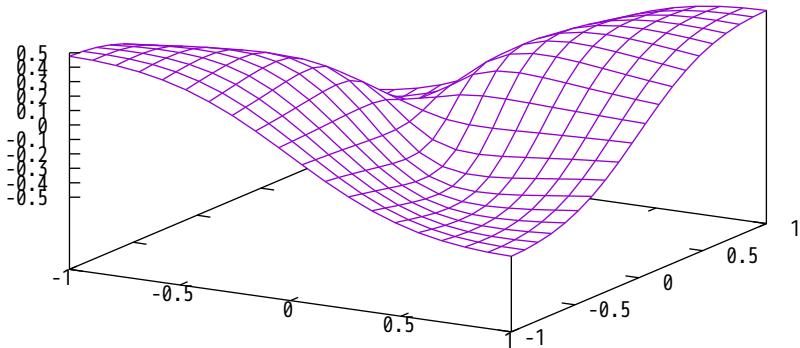



## Hidden line removal of explicit surfaces

$$\sin(x^2 + y^2) / (x^2 + y^2) \quad \text{— purple line}$$

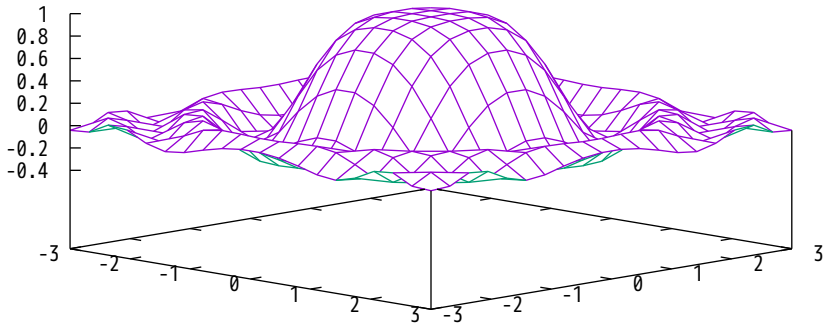

# Hidden line removal of explicit surfaces

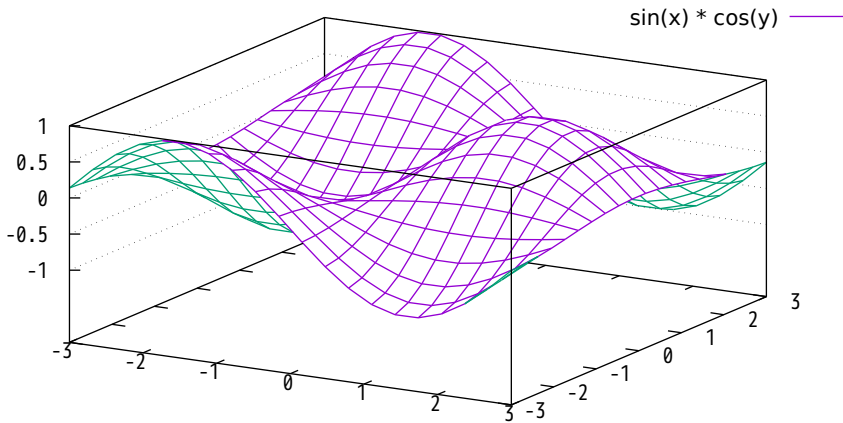

# Hidden line removal of explicit surfaces

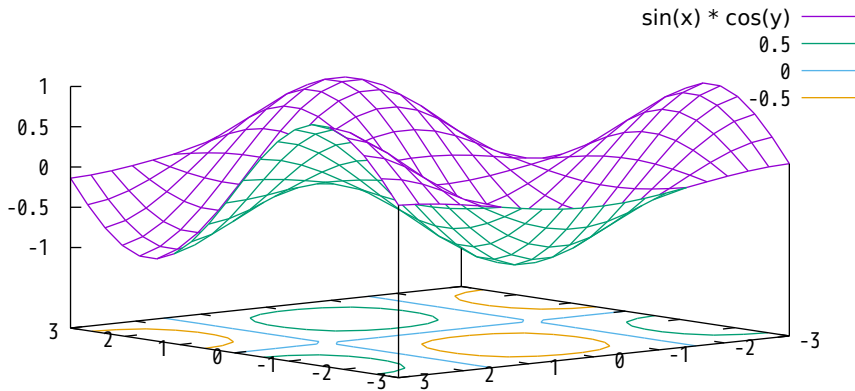

# Hidden line removal of explicit surfaces

"glass.dat" using 1

0.5

0

-0.5

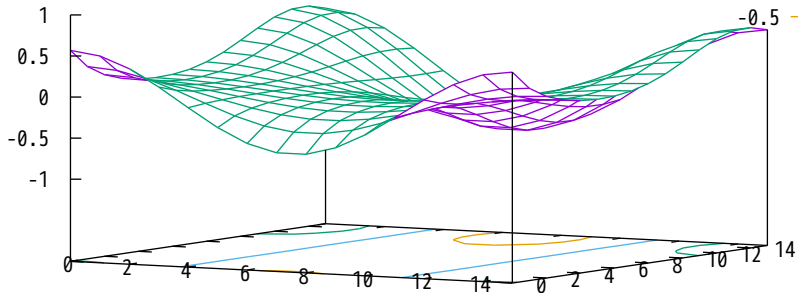

# Hidden line removal of explicit surfaces

"glass.dat" using 1 — purple  
0.5 — green  
0 — blue  
-0.5 — orange

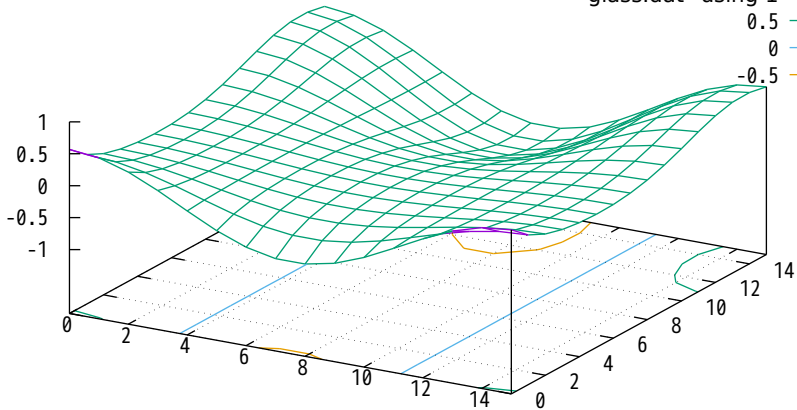

# The Valley of the Gnu

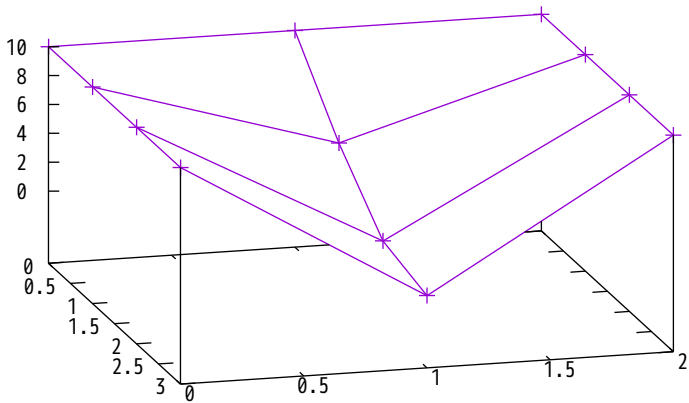

# dgrid3d splines

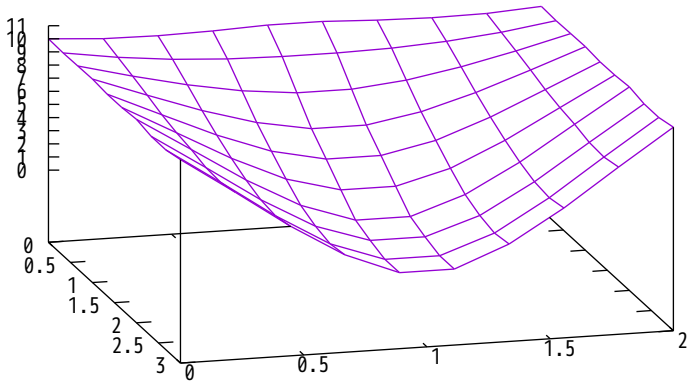

dgrid3d 30,30 qnorm 1

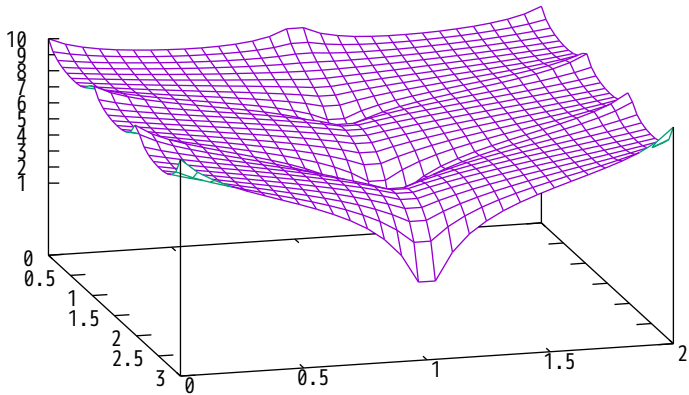



dgrid3d 30,30 qnorm 2

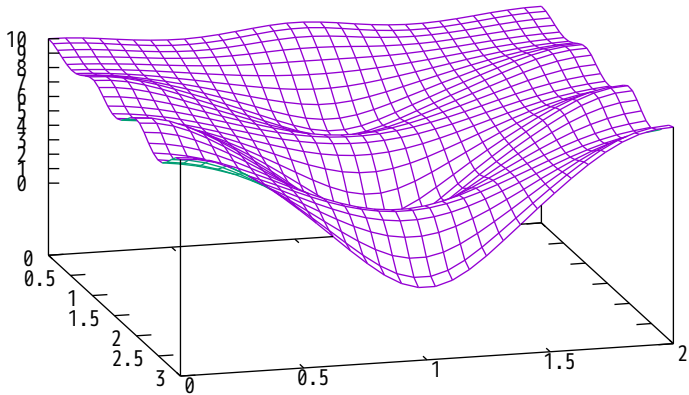

dgrid3d 30,30 qnorm 3

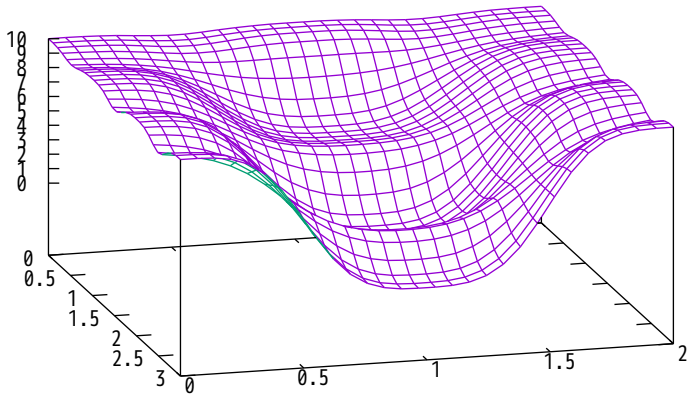

dgrid3d 30,30 qnorm 4

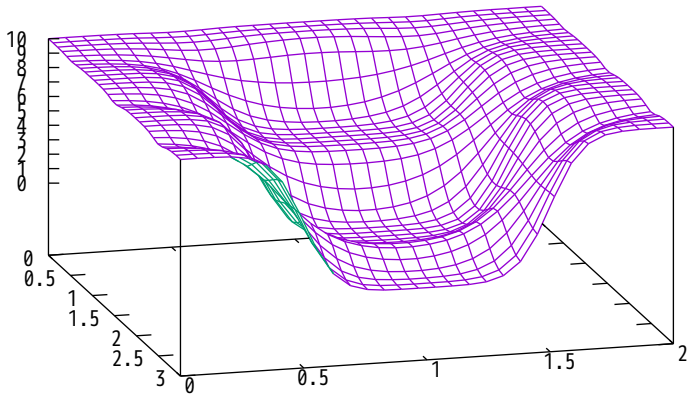

dgrid3d 30,30 qnorm 5

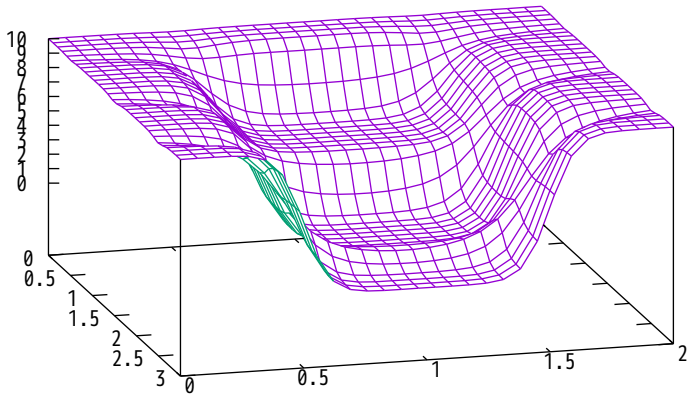

dgrid3d 30,30 gauss 1

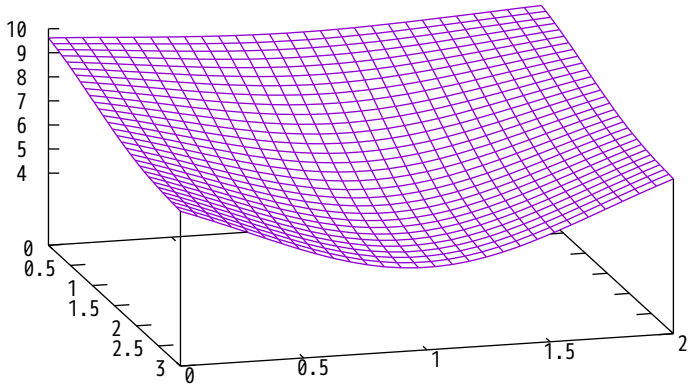

dgrid3d 30,30 gauss .75

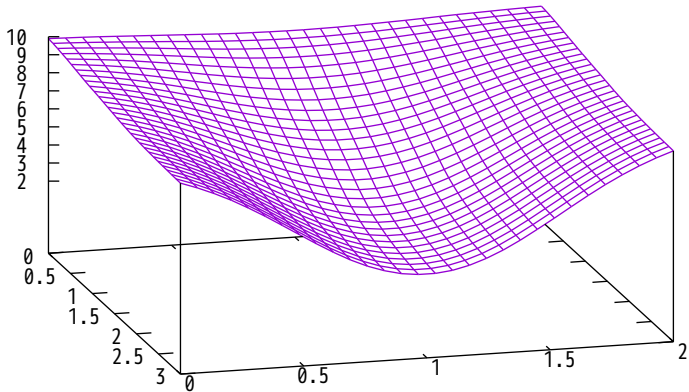

dgrid3d 30,30 gauss .5

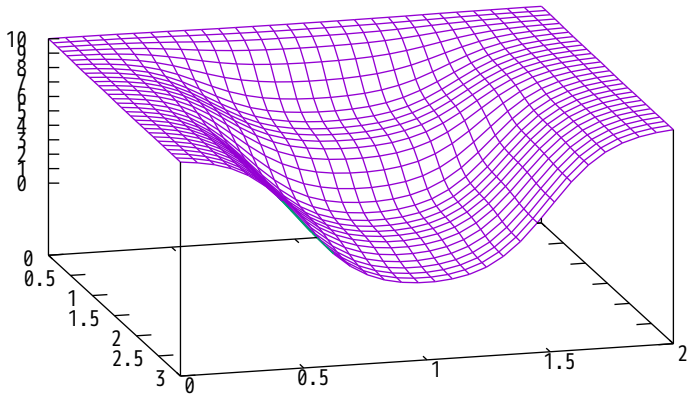

dgrid3d 30,30 gauss .35

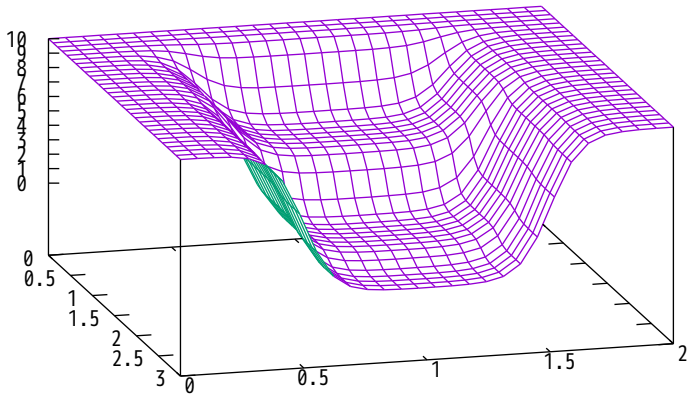



dgrid3d 30,30 gauss .25

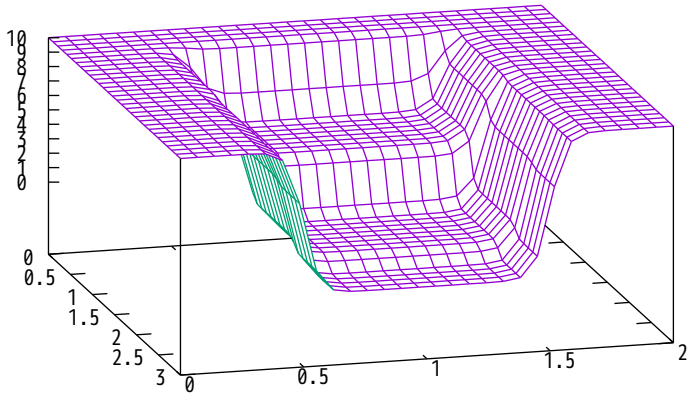

dgrid3d 30,30 gauss .5,.35

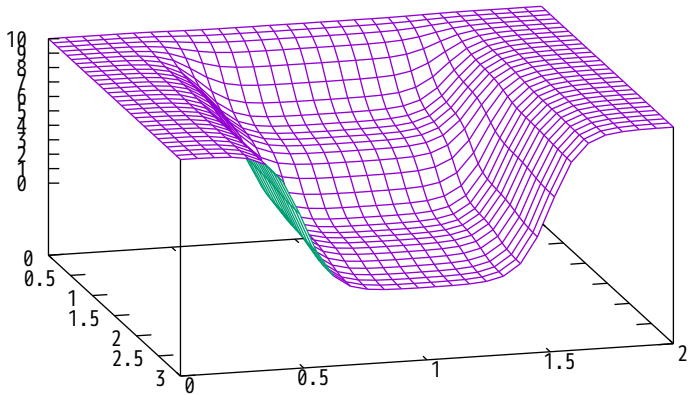

dgrid3d 30,30 gauss .35,.5

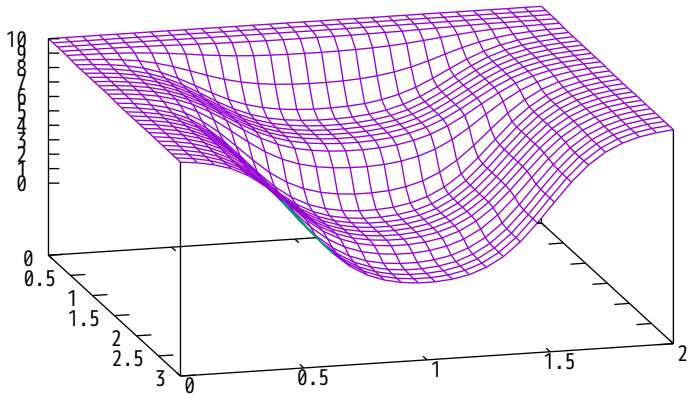

# Gnuplot Correspondences

## geographic coordinate system

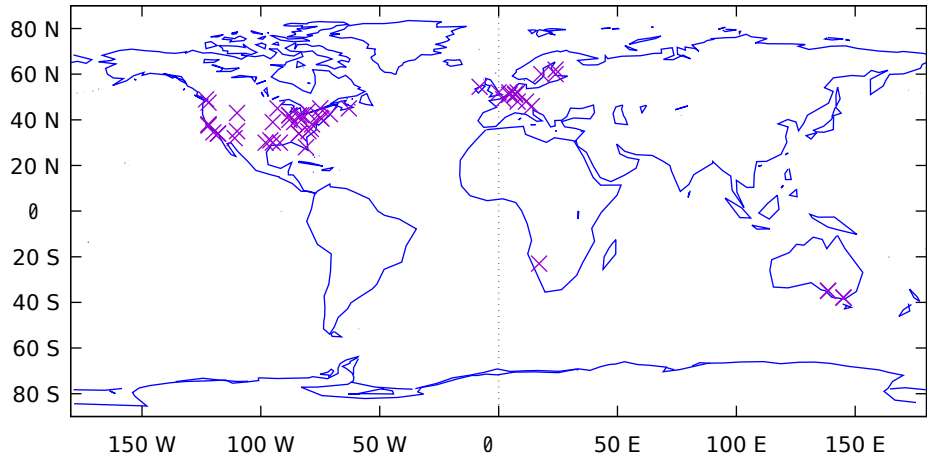

3D version using spherical coordinate system

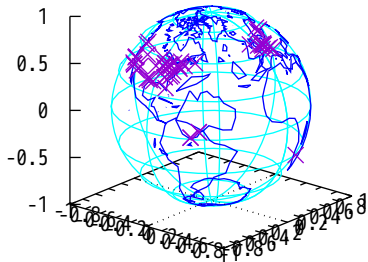

## 3D solid version with hidden line removal

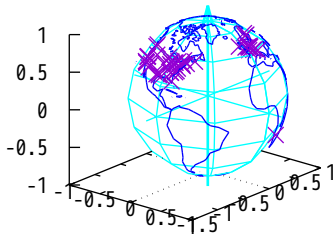

3D version using cylindrical coordinate system

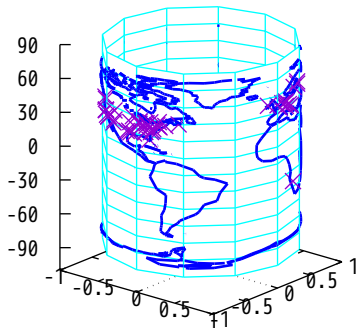

Labels colored by GeV plotted in spherical coordinate system

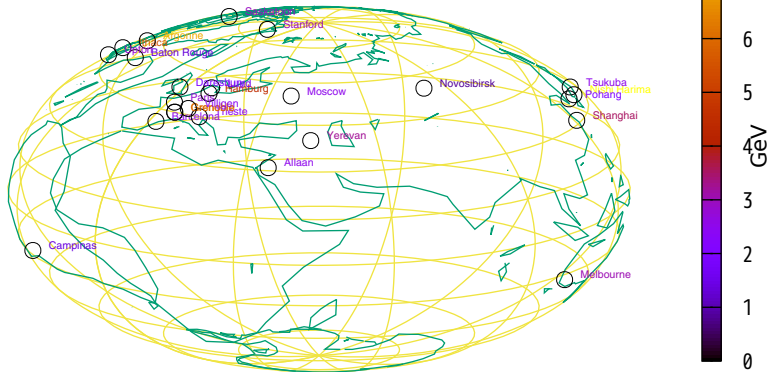



# Labels with hidden line removal

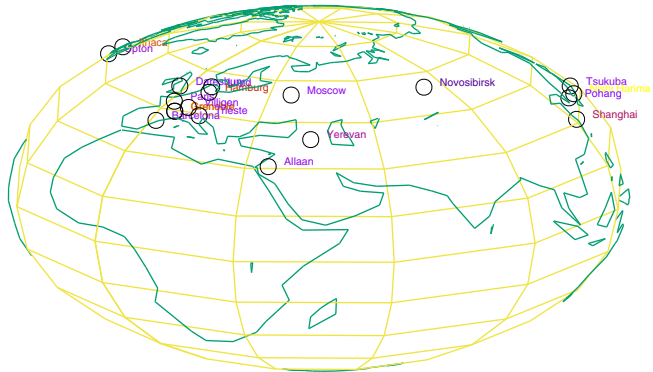

8  
7  
6  
5  
4 GeV  
3  
2  
1  
0

gamma function, very useful function for probability

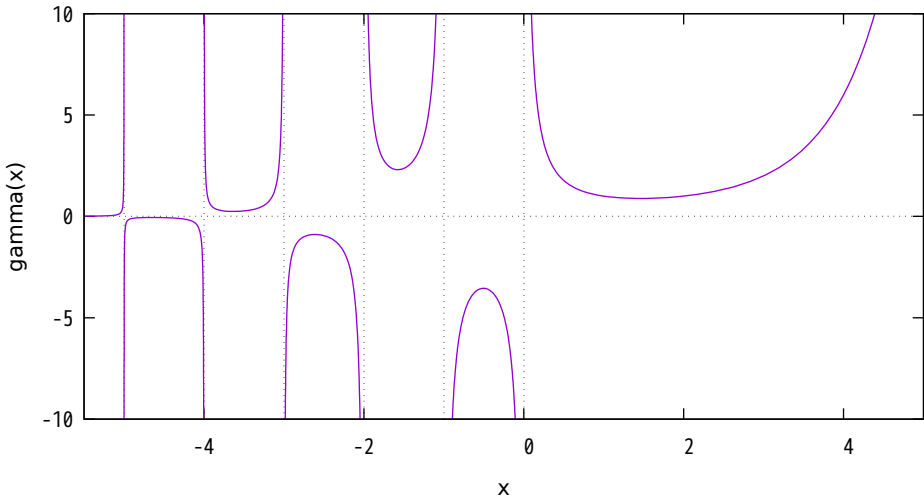

log gamma function, similarly very useful function

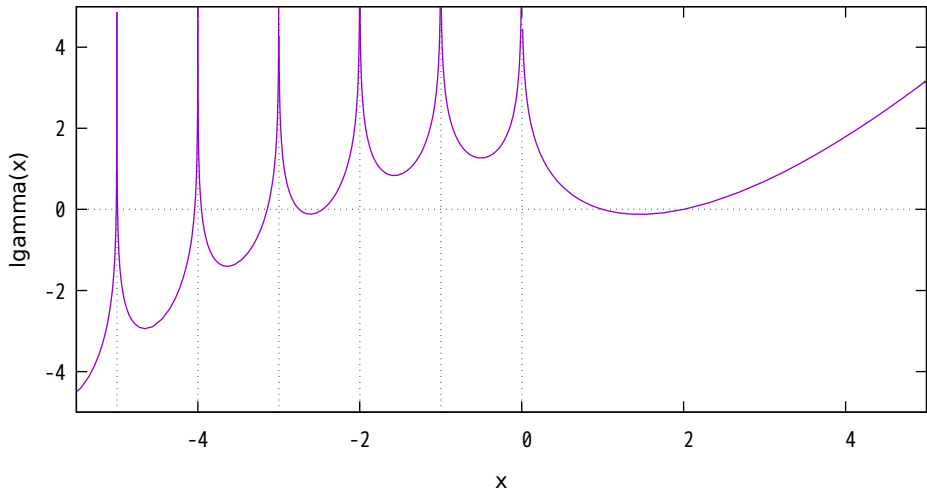

arcsin PDF with  $r = 2.0$

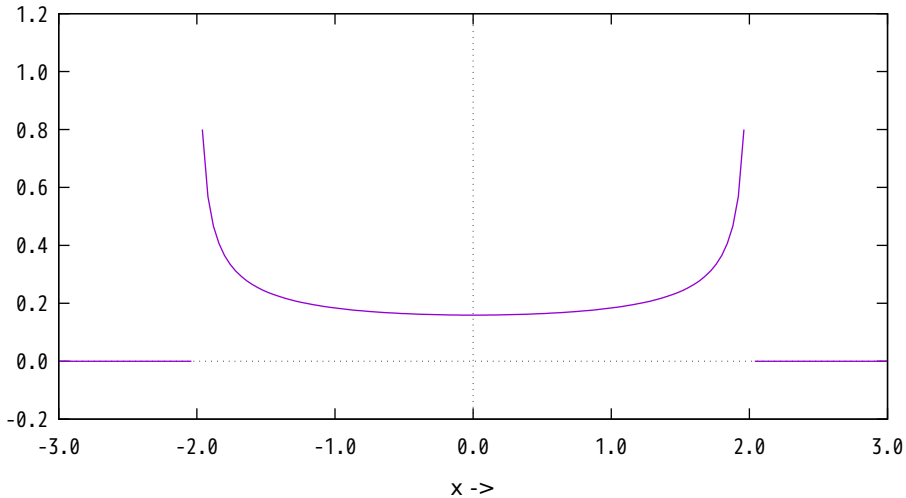

arcsin CDF with  $r = 2.0$

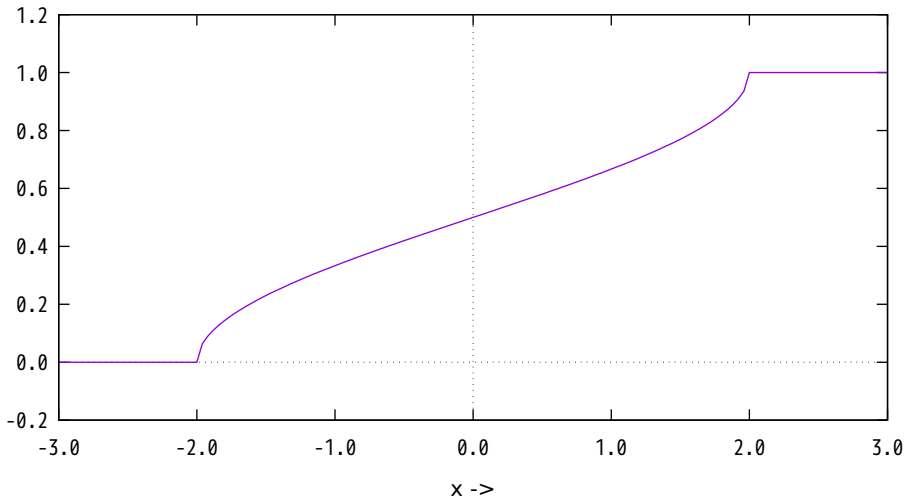

beta PDF

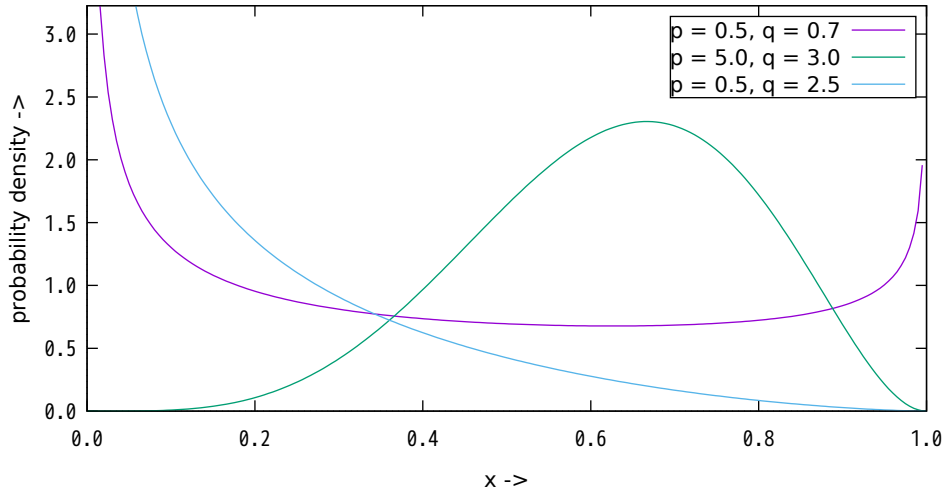

incomplete beta CDF

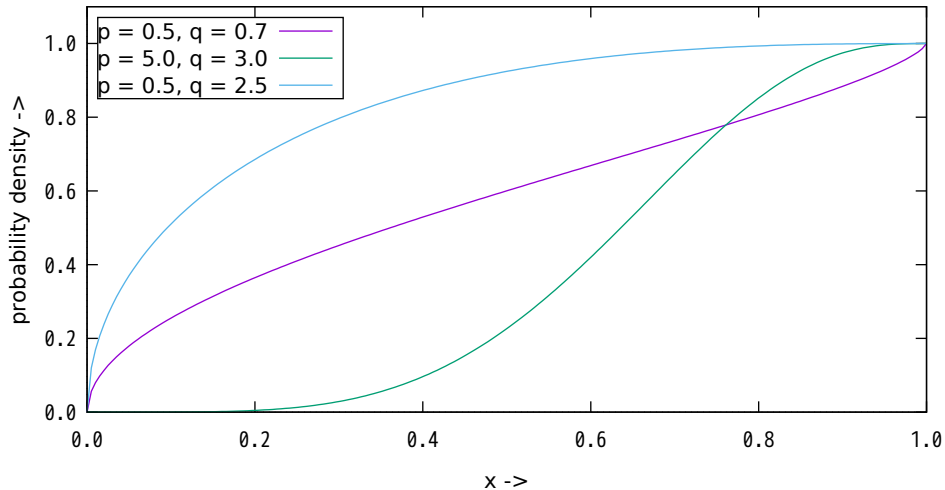

binomial PDF with  $n = 25$ ,  $p = 0.15$

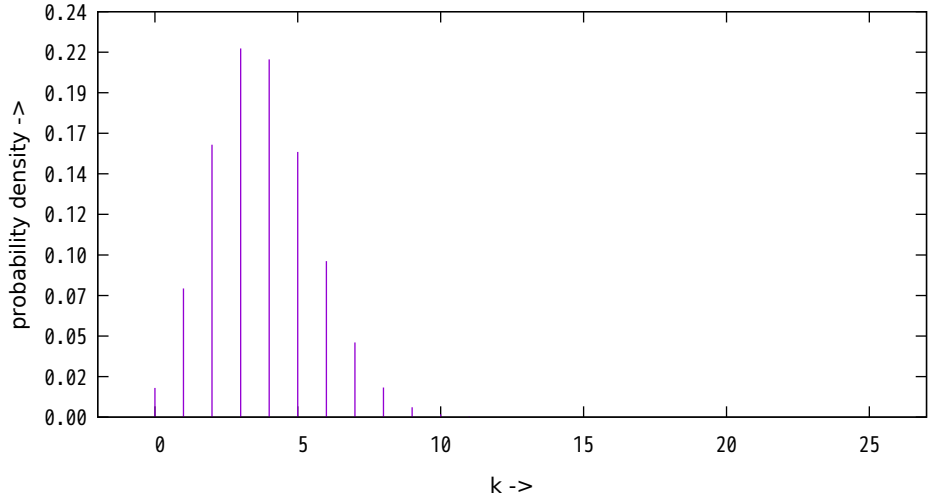



binomial CDF with  $n = 25$ ,  $p = 0.15$

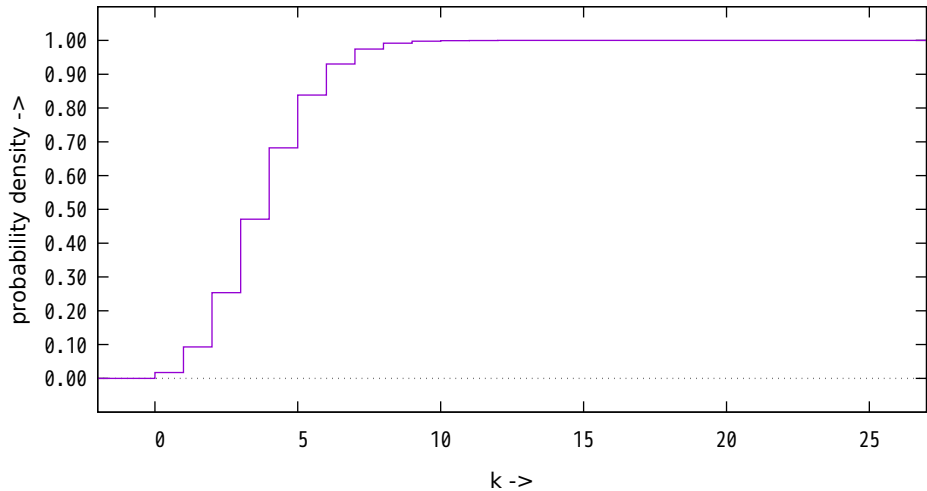

cauchy PDF

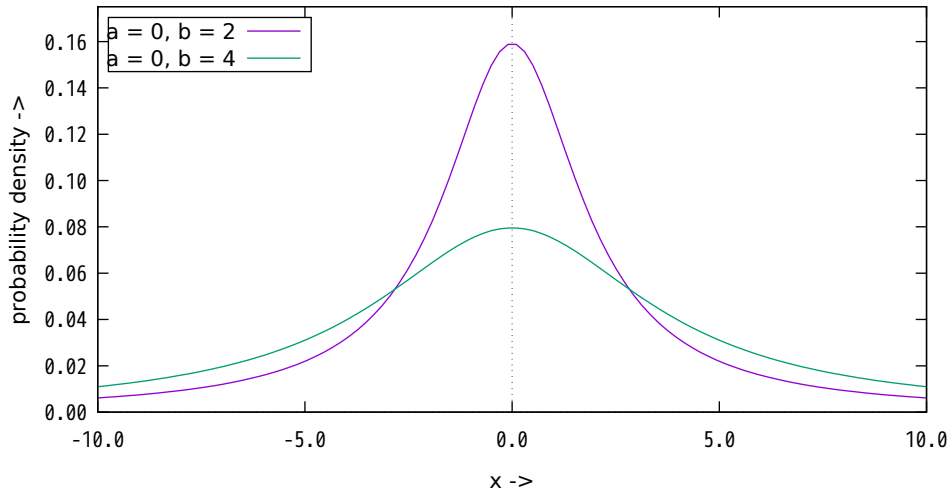

cauchy CDF

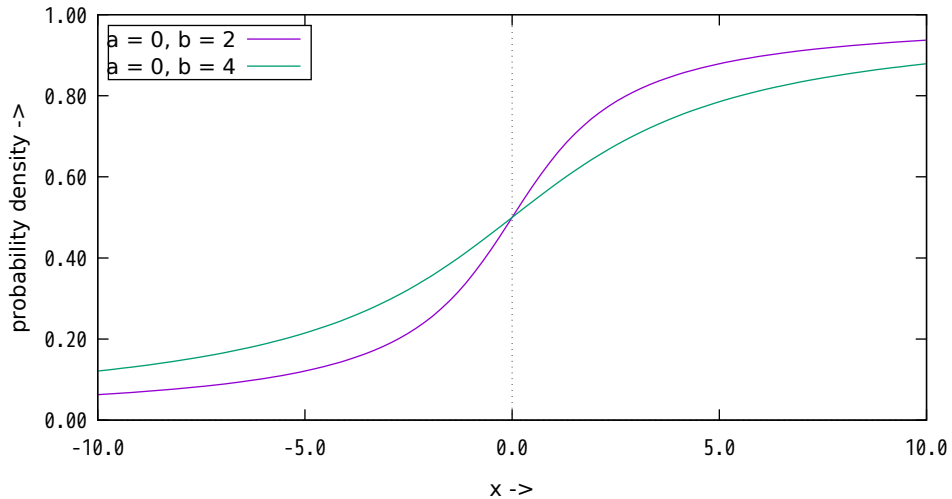



chi-square CDF

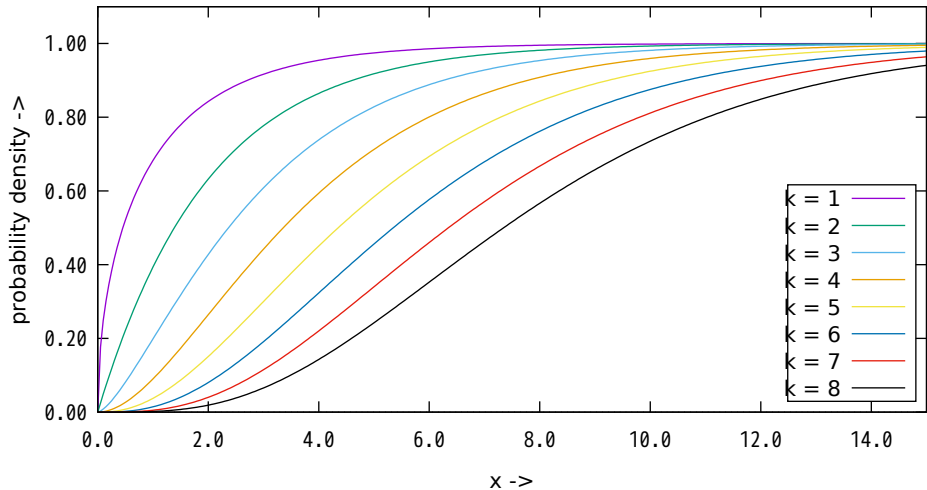

erlang PDF

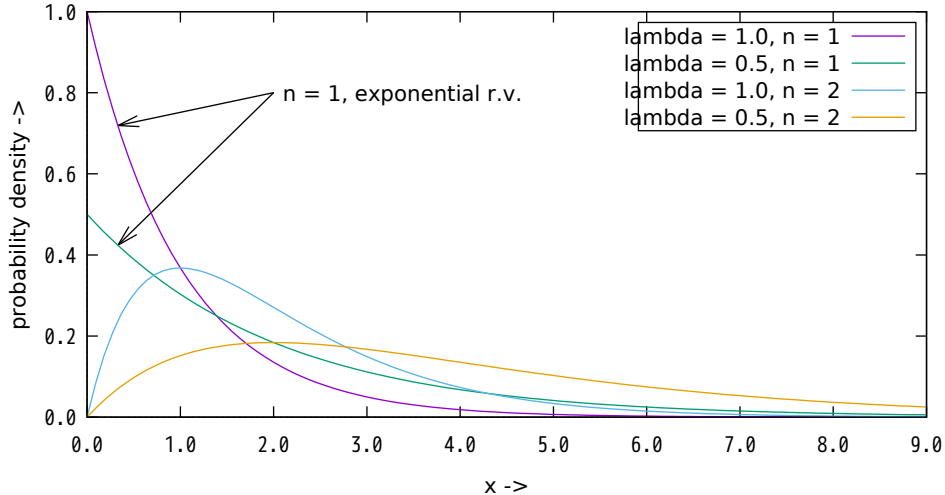

erlang CDF

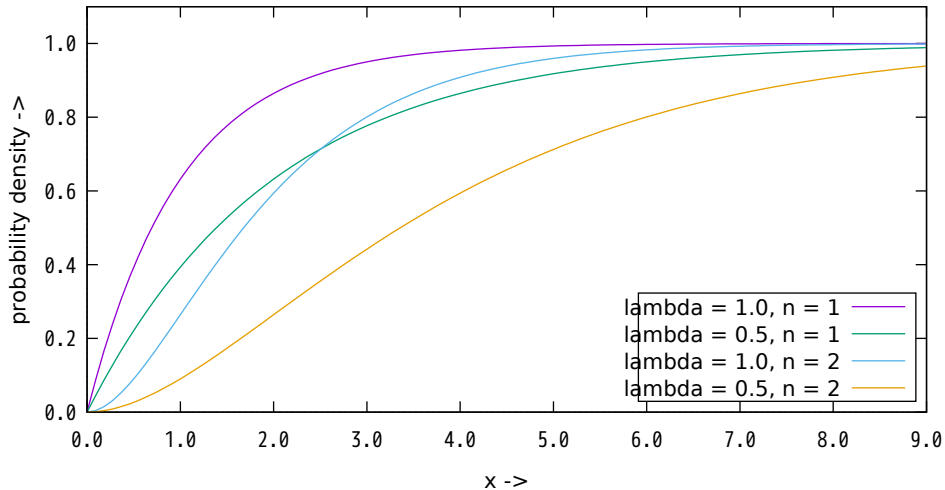

# extreme PDF

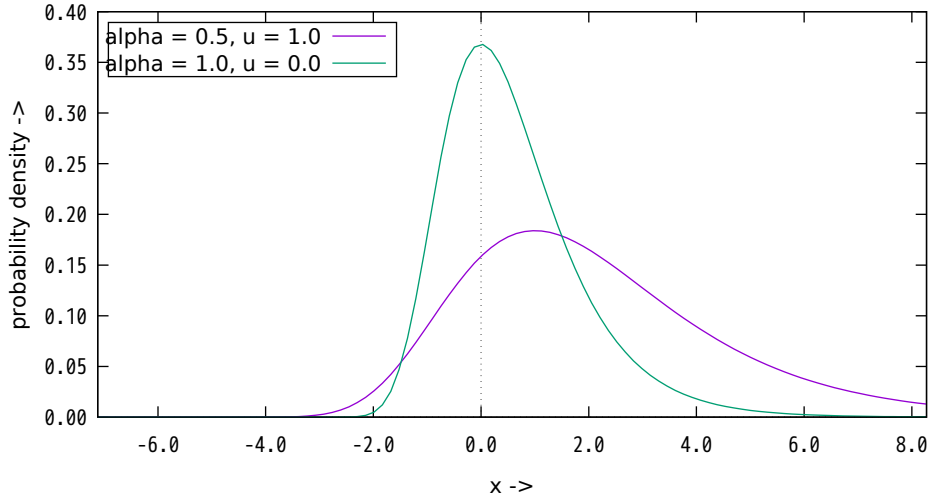



# extreme CDF

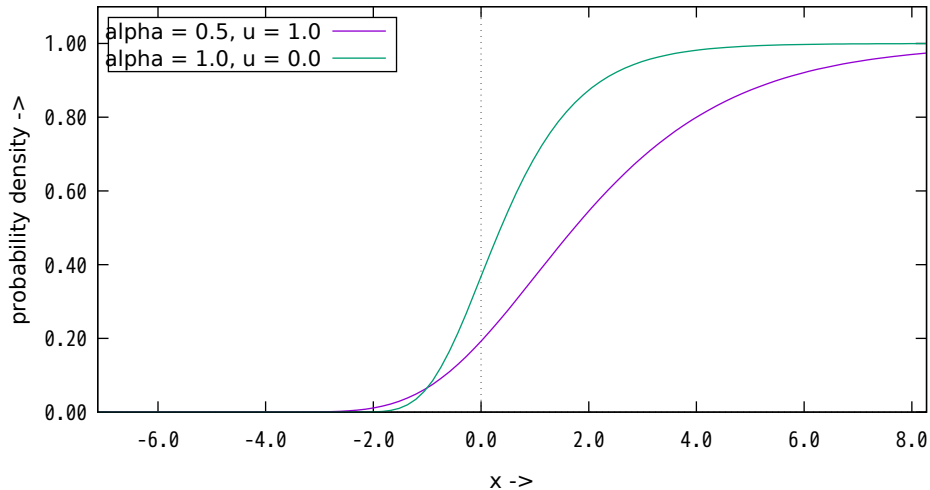

F PDF

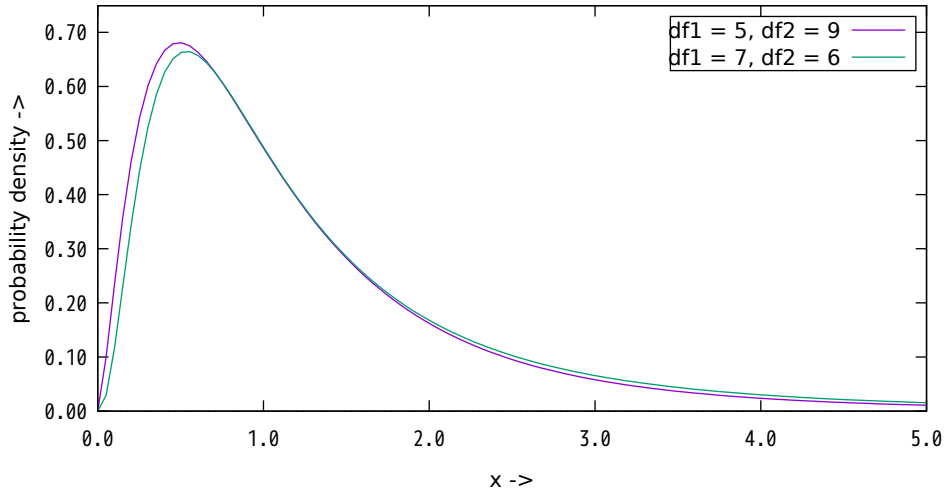

F CDF

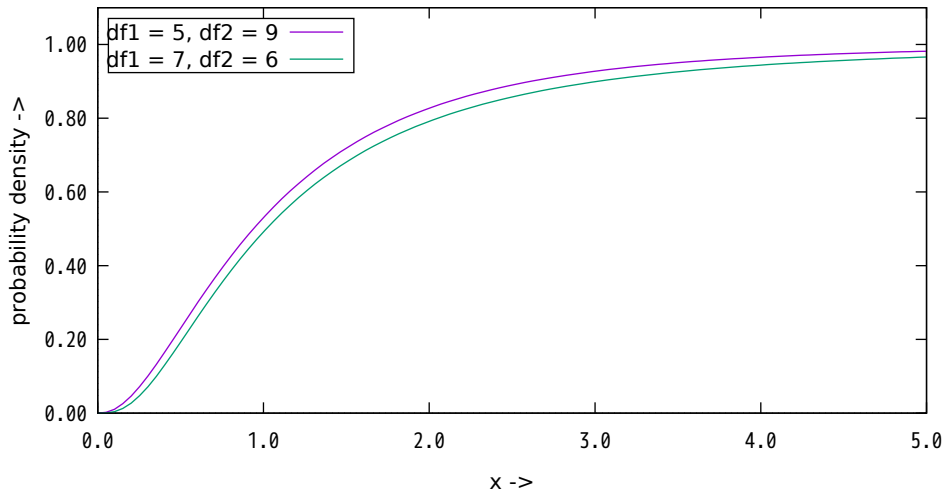

gamma PDF

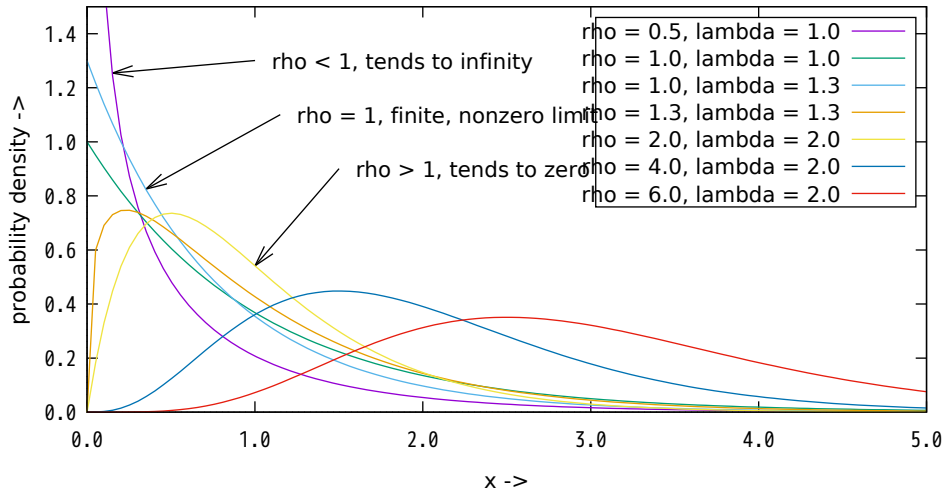

incomplete gamma CDF

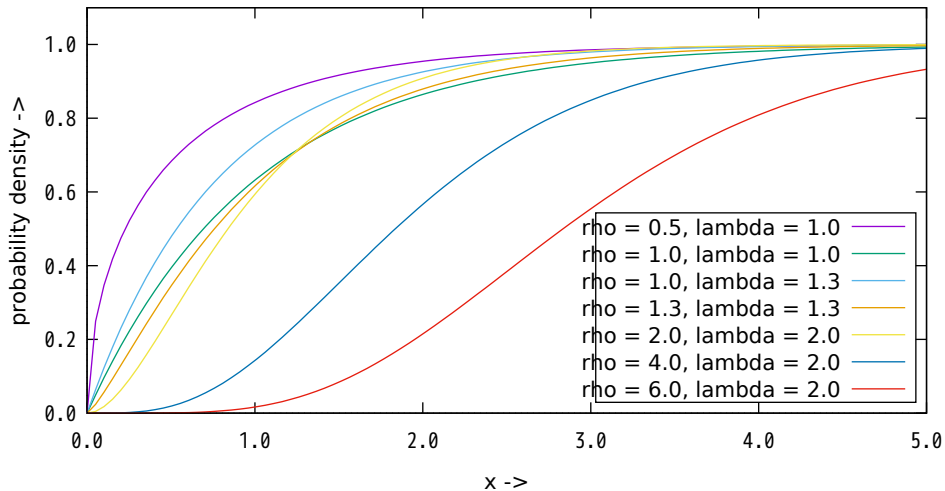

geometric PDF with  $p = 0.4$

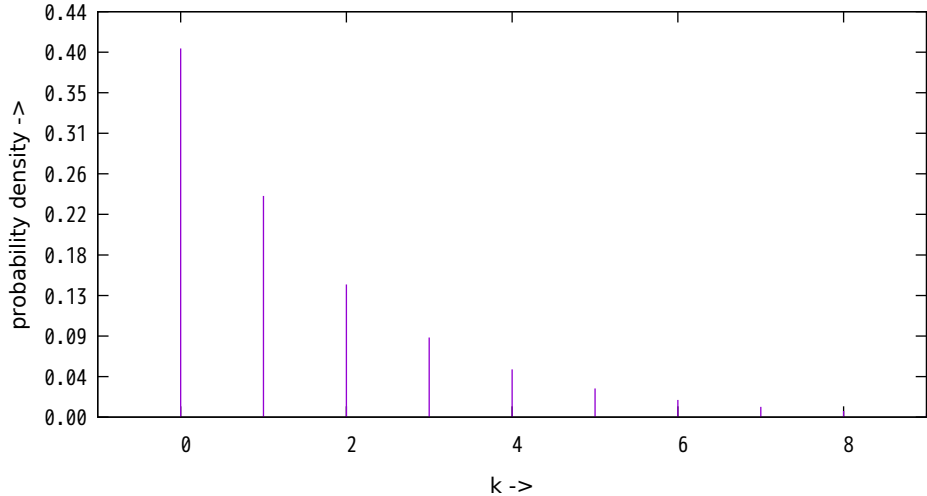

geometric CDF with  $p = 0.4$

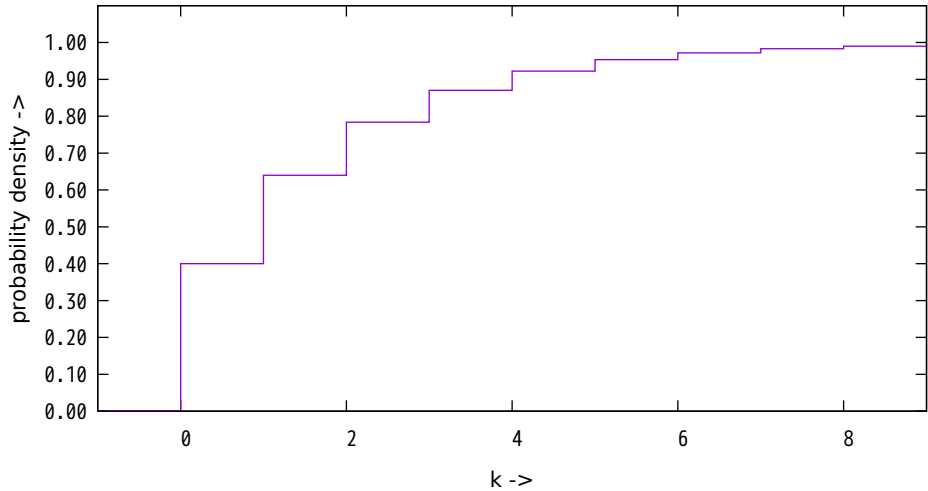

half normal PDF, sigma = 1.0

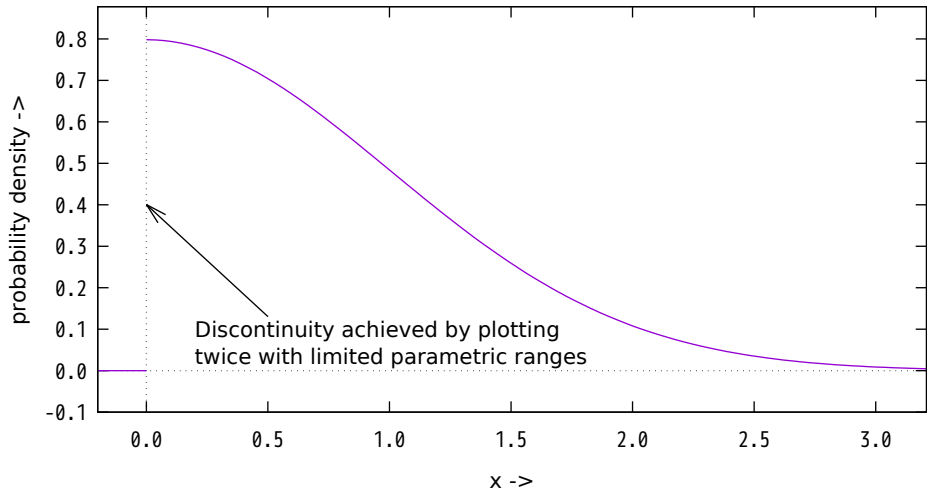



half normal CDF, sigma = 1.0

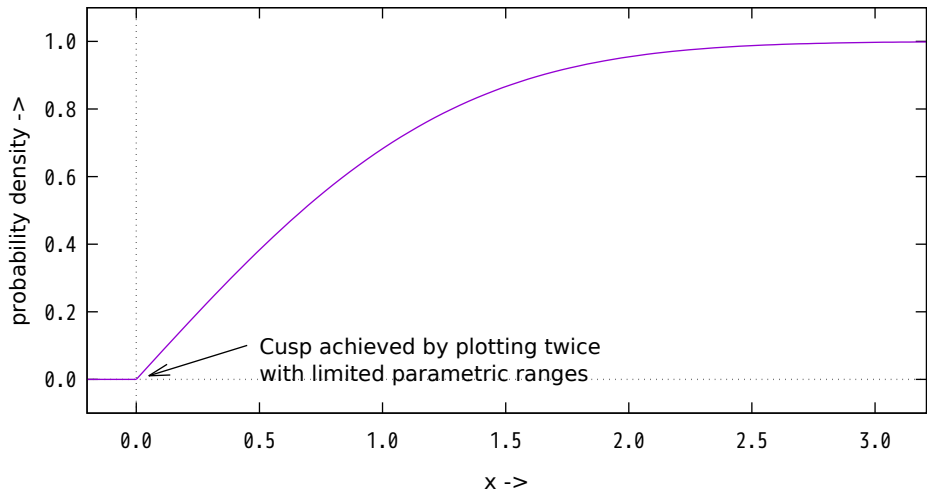

hypergeometric PDF with  $N = 75$ ,  $C = 25$ ,  $d = 10$

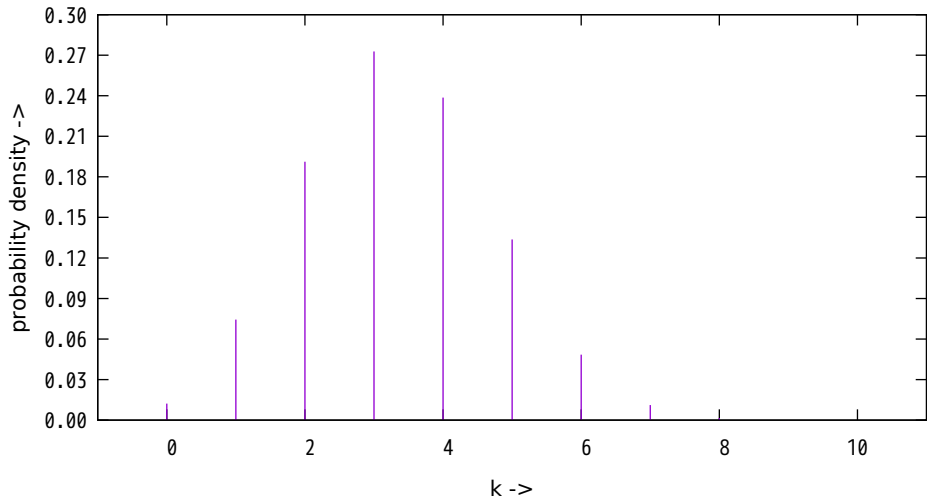

hypergeometric CDF with  $N = 75$ ,  $C = 25$ ,  $d = 10$

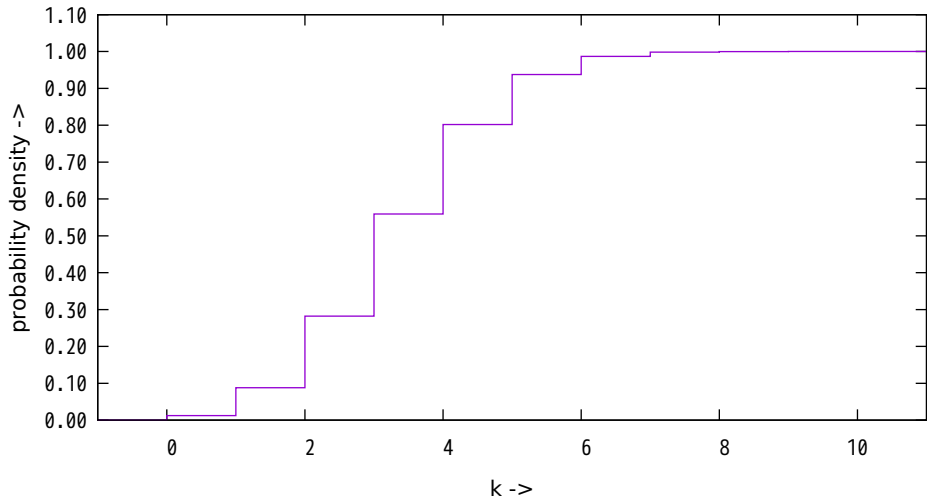

laplace (or double exponential) PDF with  $\mu = 0$ ,  $b = 1$

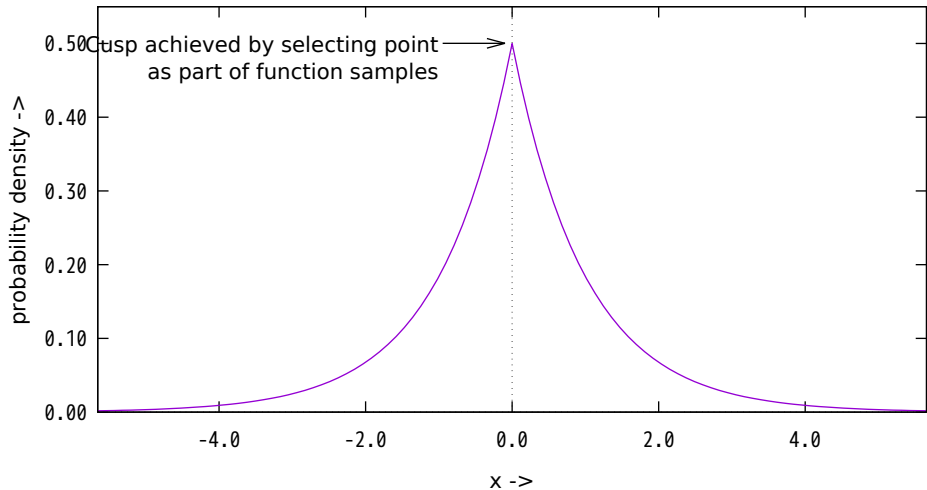

laplace (or double exponential) CDF with  $\mu = 0$ ,  $b = 1$

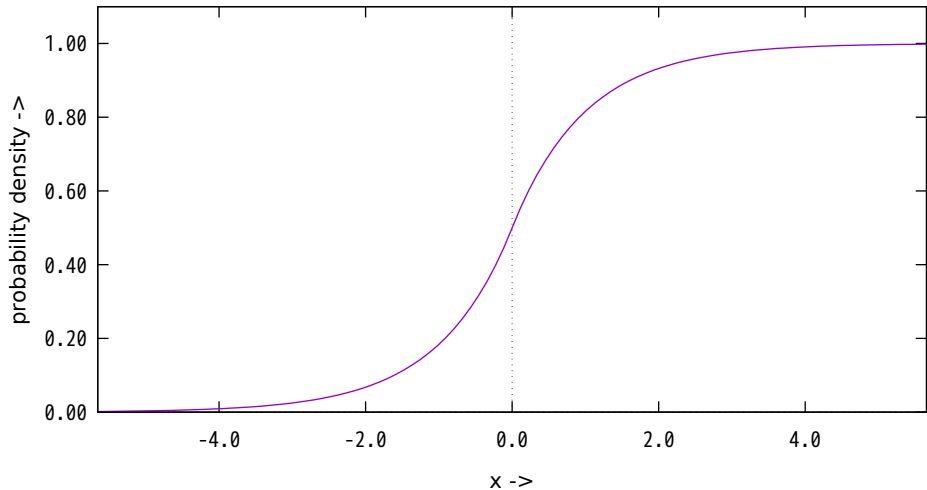

logistic PDF with  $a = 0$ ,  $\lambda = 2$

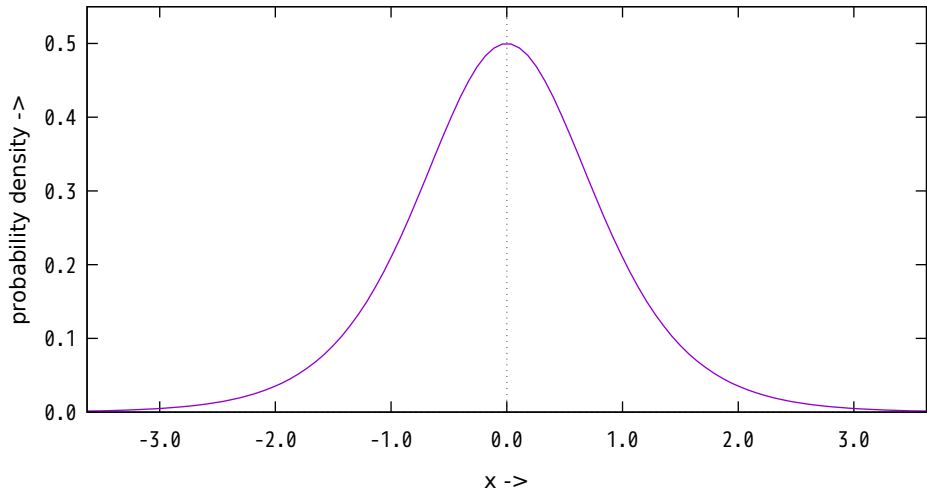

logistic CDF with  $a = 0$ ,  $\lambda = 2$

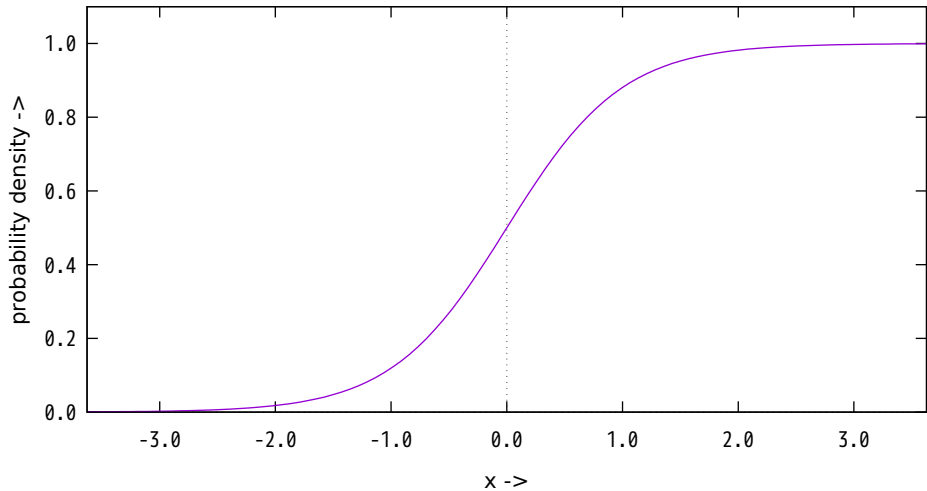

lognormal PDF with  $\mu = 1.0$ ,  $\sigma = 0.5$

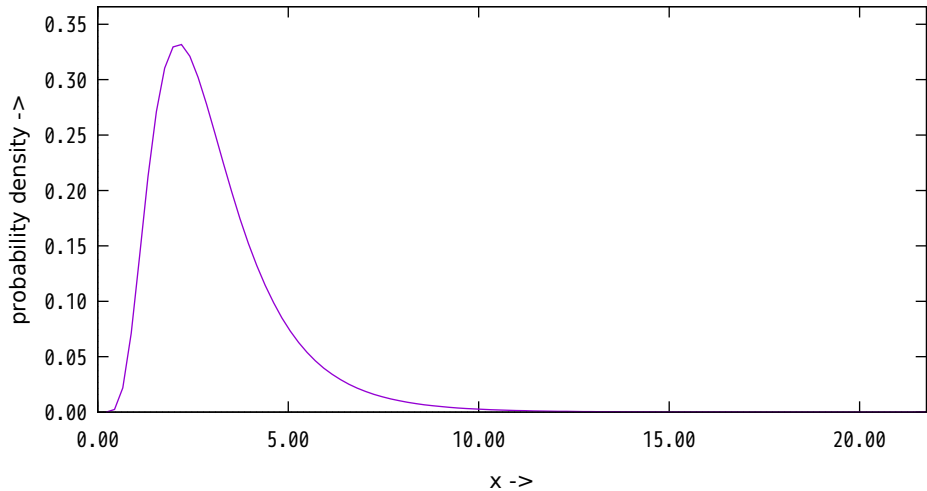



lognormal CDF with  $\mu = 1.0$ ,  $\sigma = 0.5$

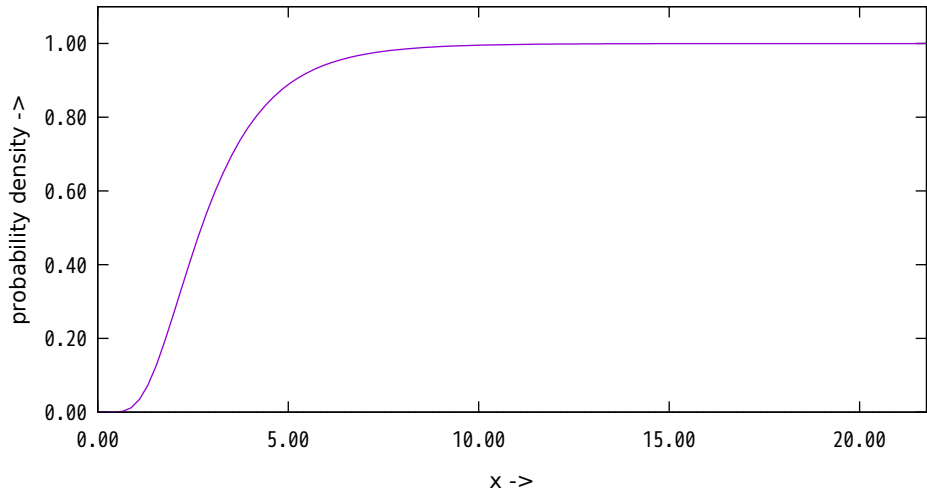

maxwell PDF

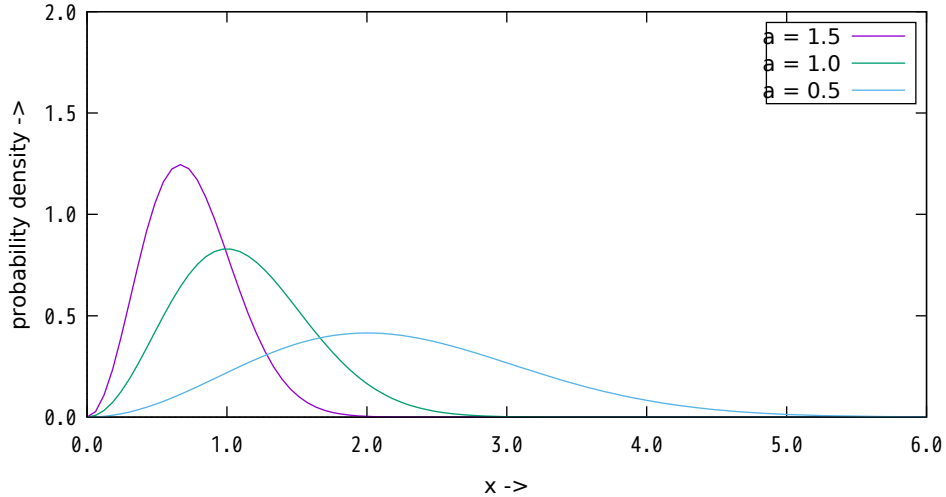

maxwell CDF

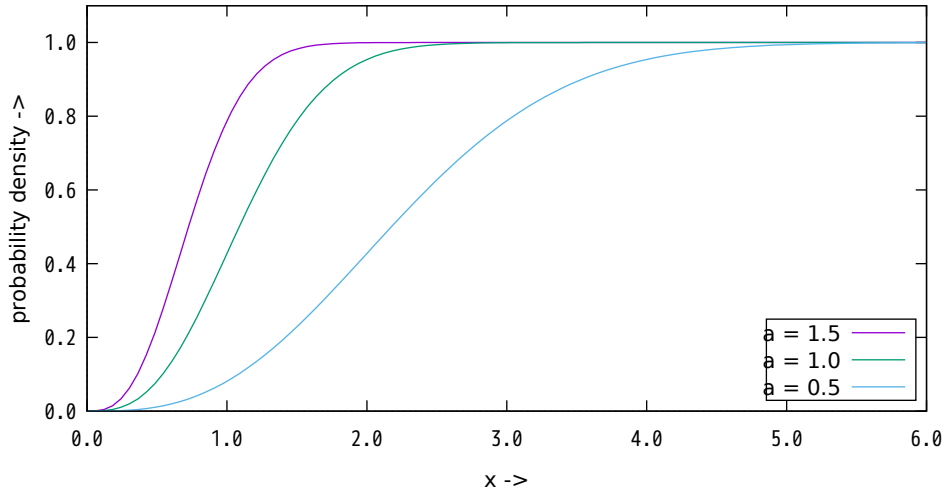

negative binomial (or pascal or polya) PDF with  $r = 8$ ,  $p = 0.4$

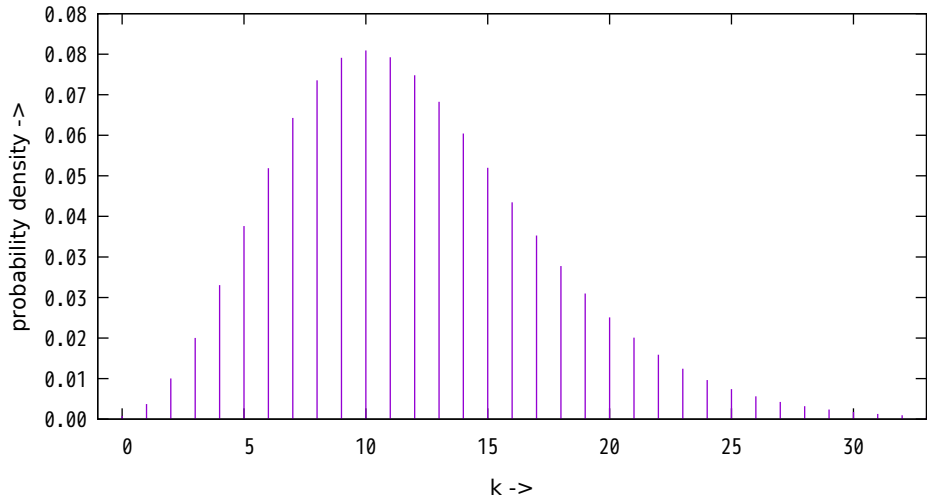

negative binomial (or pascal or polya) CDF with  $r = 8$ ,  $p = 0.4$

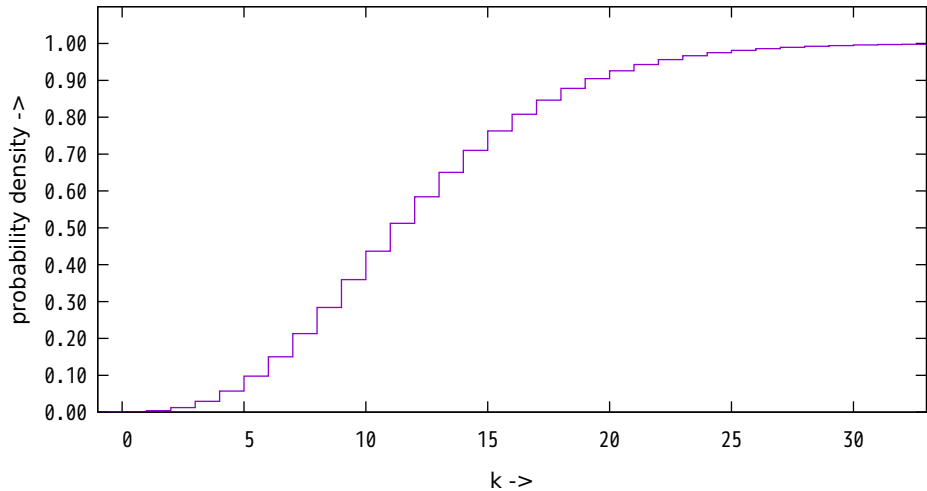

negative exponential (or exponential) PDF with lambda = 2.0

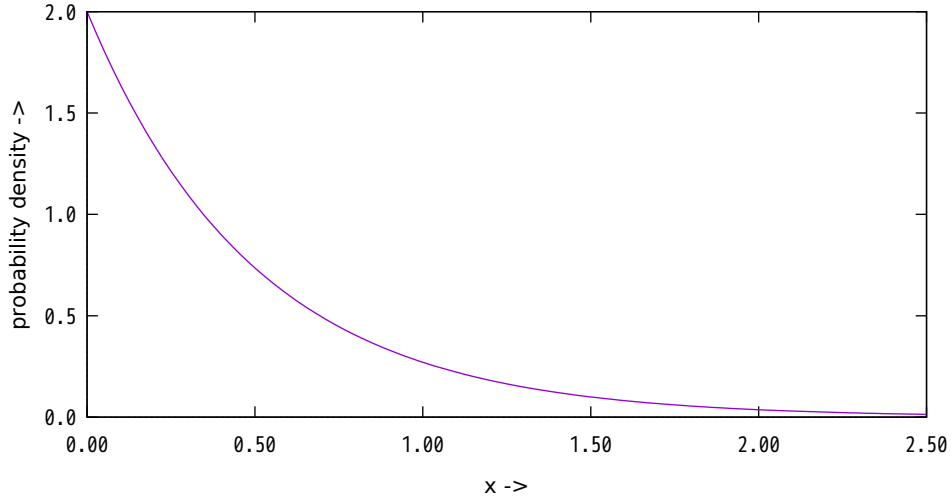

negative exponential (or exponential) CDF with lambda = 2.0

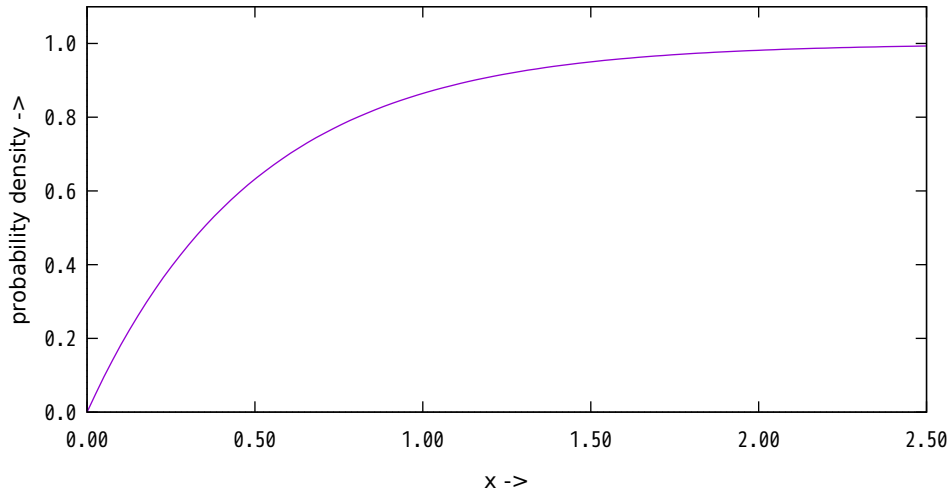

normal (also called gauss or bell-curved) PDF

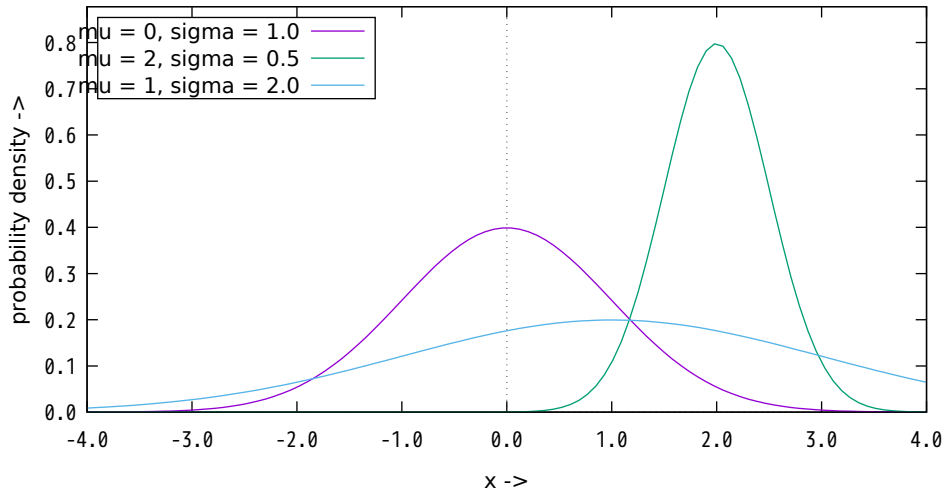



normal (also called gauss or bell-curved) CDF

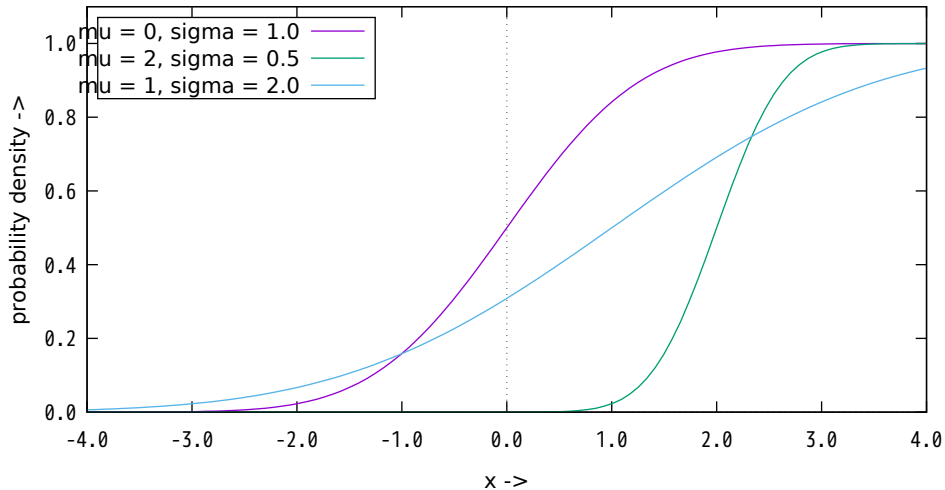

pareto PDF with  $a = 1$ ,  $b = 3$

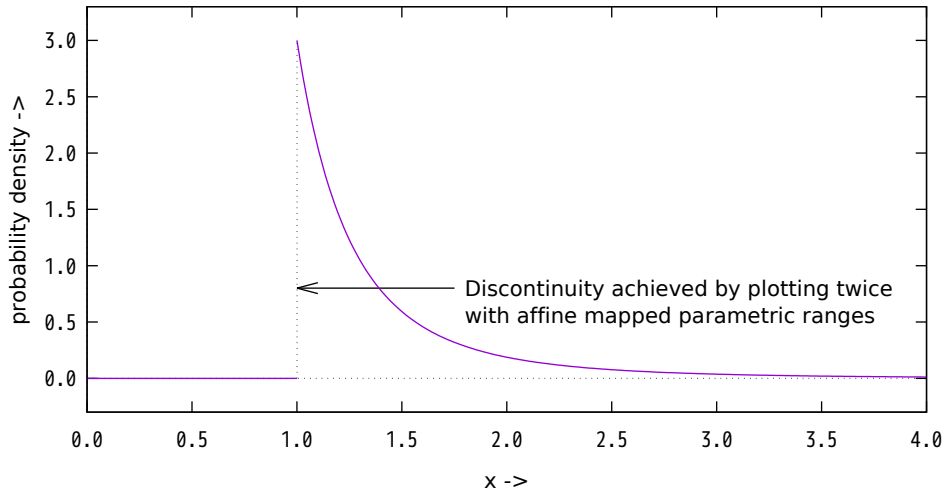

pareto CDF with  $a = 1$ ,  $b = 3$

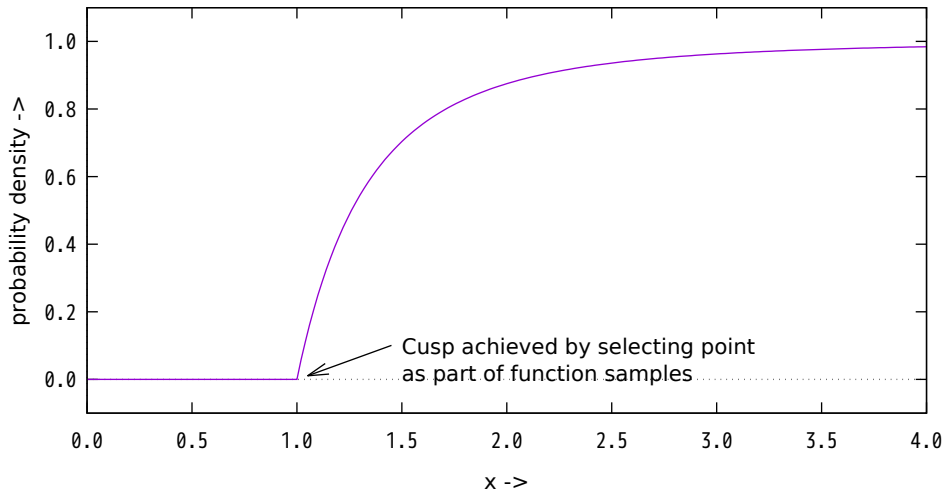

poisson PDF with  $\mu = 4.0$

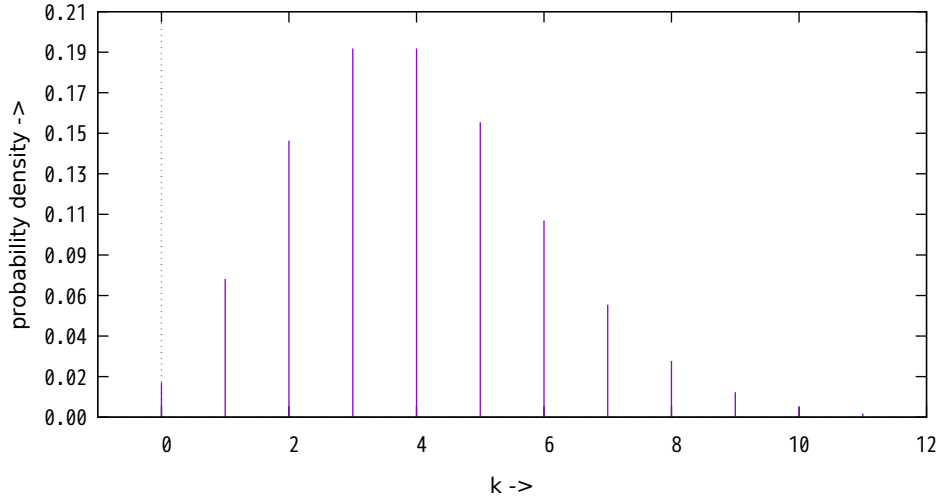

poisson CDF with mu = 4.0

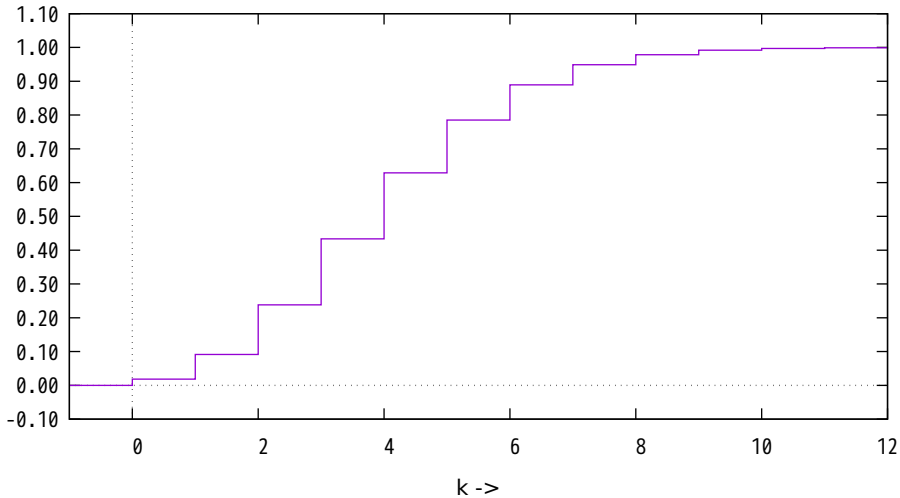

rayleigh PDF with lambda = 2.0

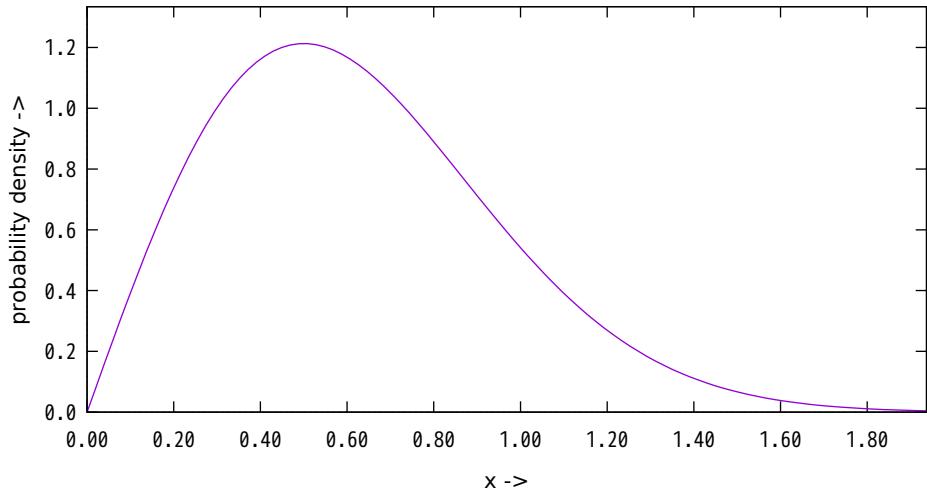

rayleigh CDF with lambda = 2.0

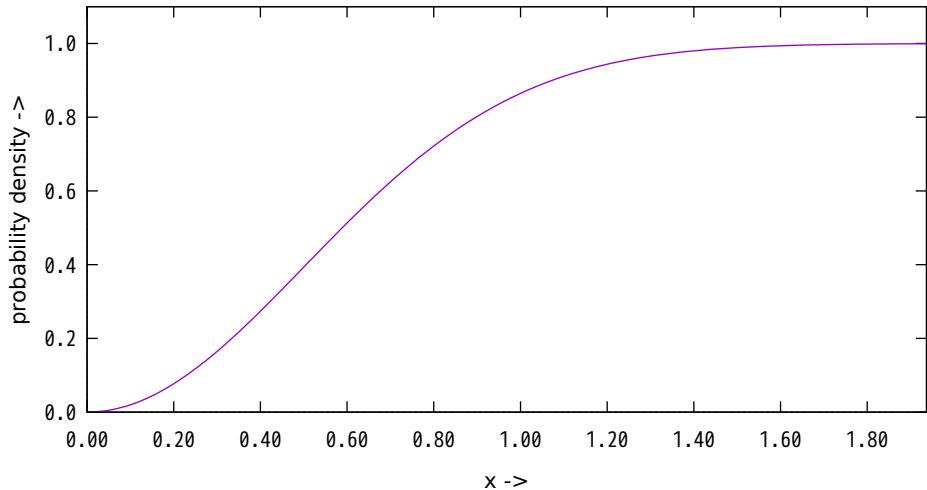

sine PDF

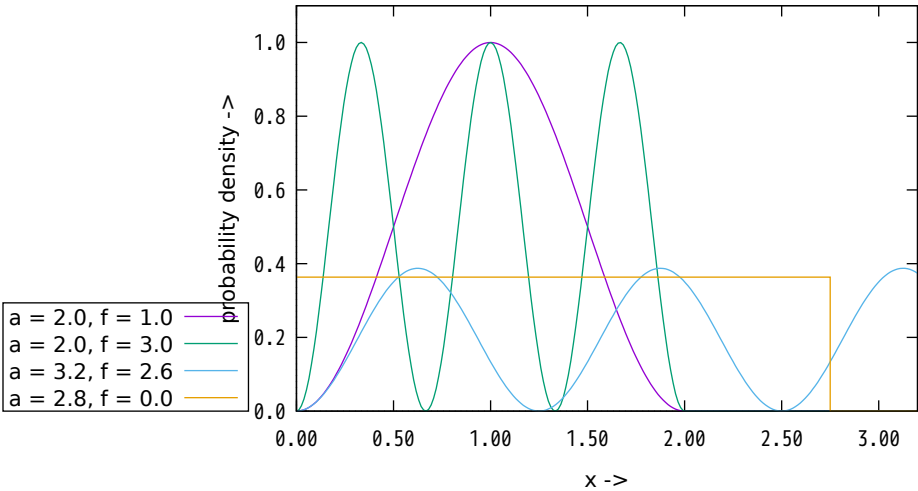



sine CDF

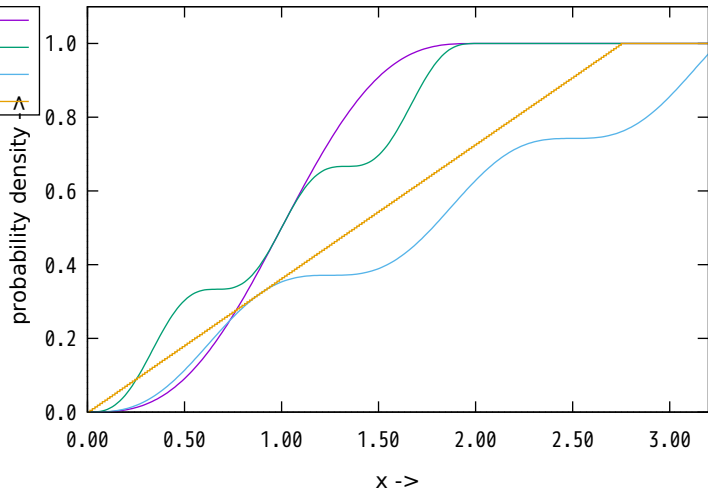
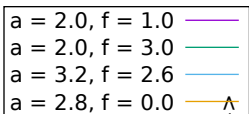

t PDF (and Gaussian limit)

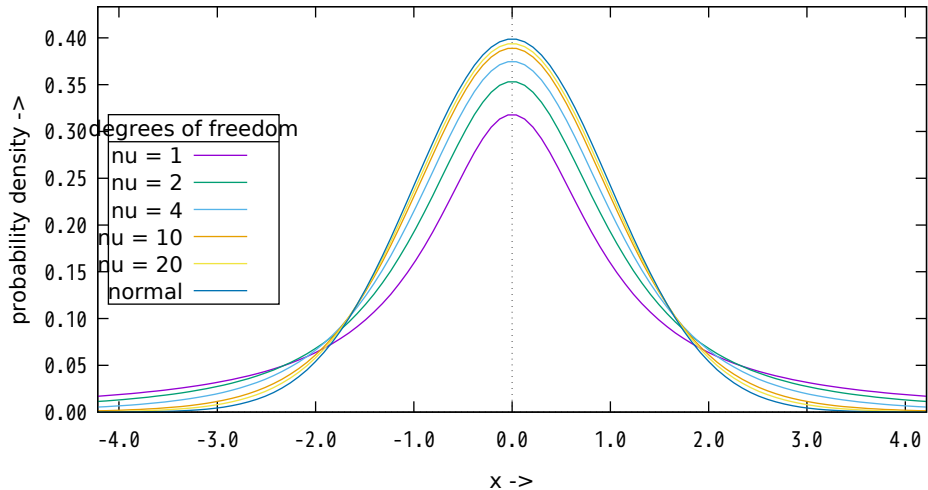

t CDF (and Gaussian limit)

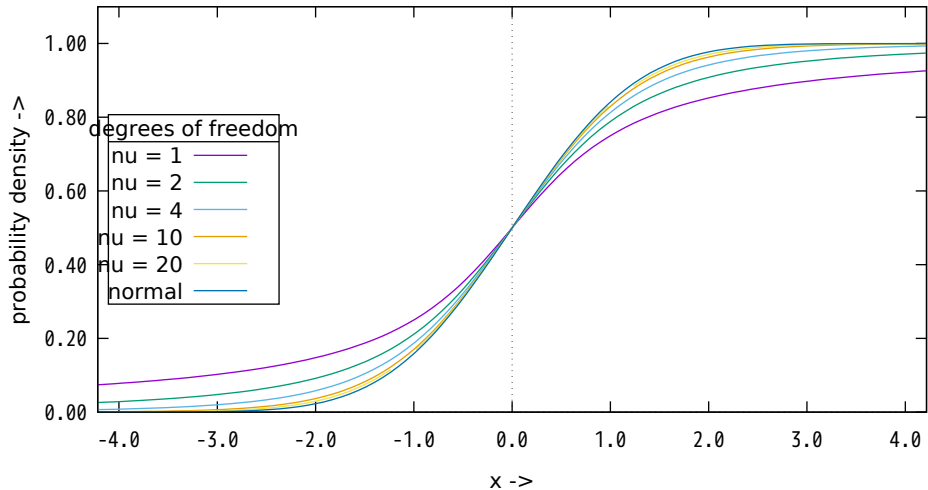

triangular PDF with  $m = 3.0$ ,  $g = 2.0$

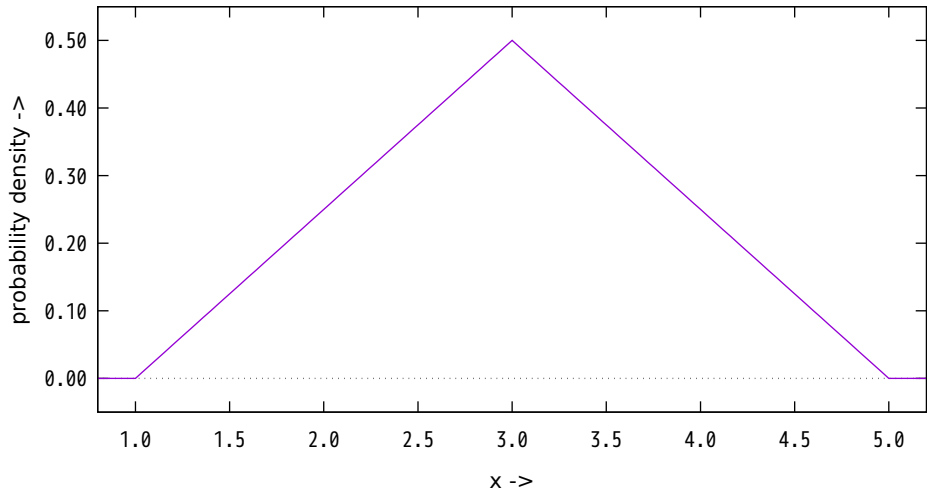

triangular CDF with  $m = 3.0$ ,  $g = 2.0$

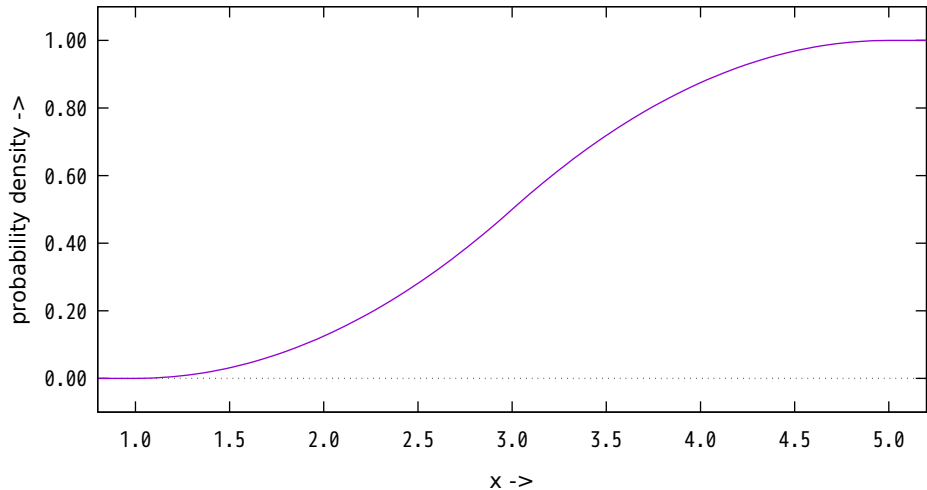

uniform PDF with  $a = -2.0$ ,  $b = 2.0$

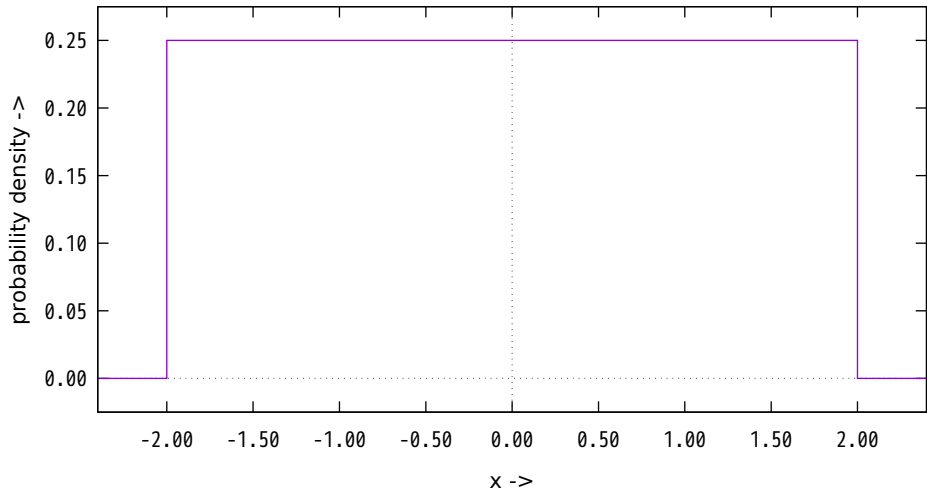

uniform CDF with  $a = -2.0$ ,  $b = 2.0$

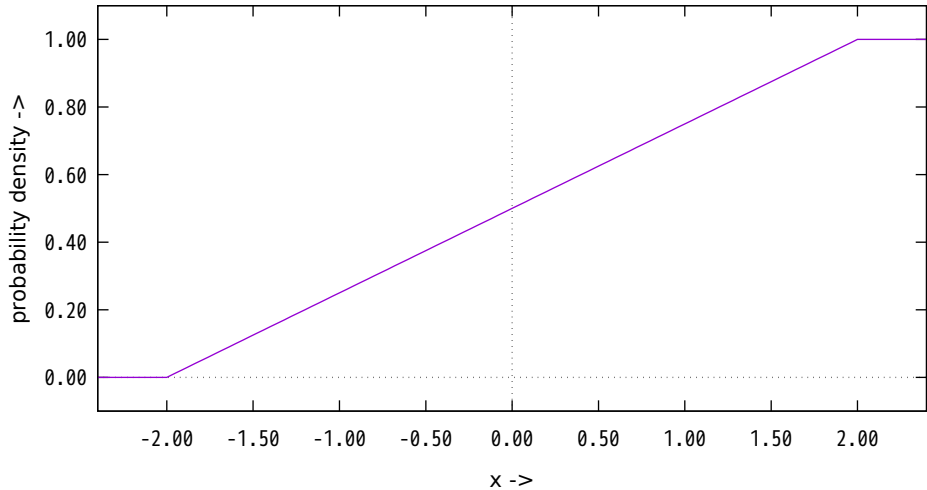

weibull PDF

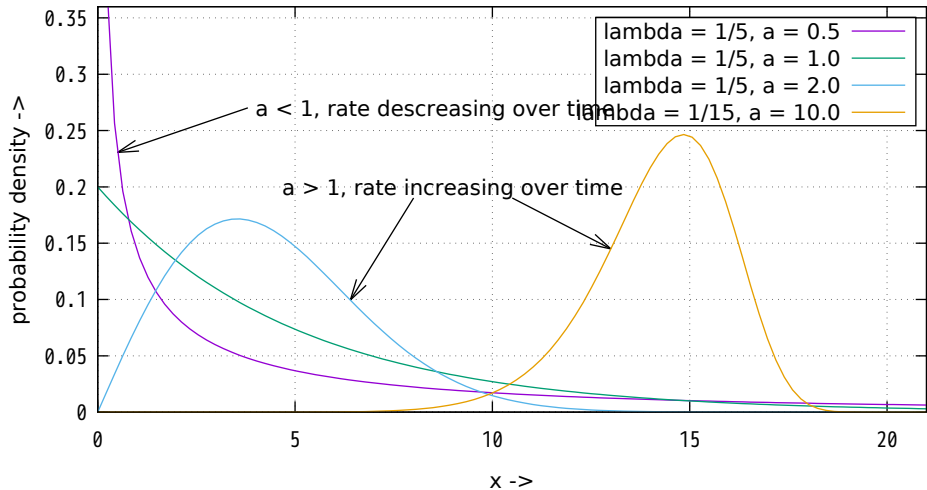



weibull CDF

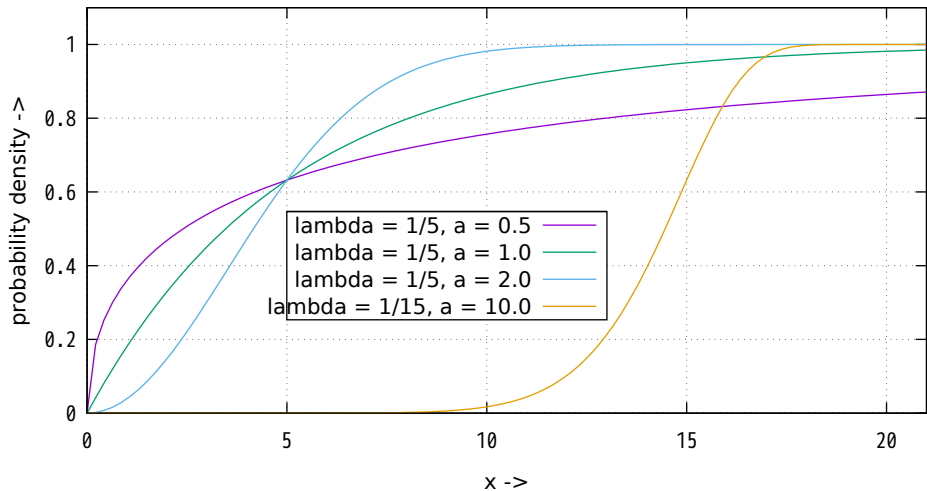

binomial PDF using normal approximation

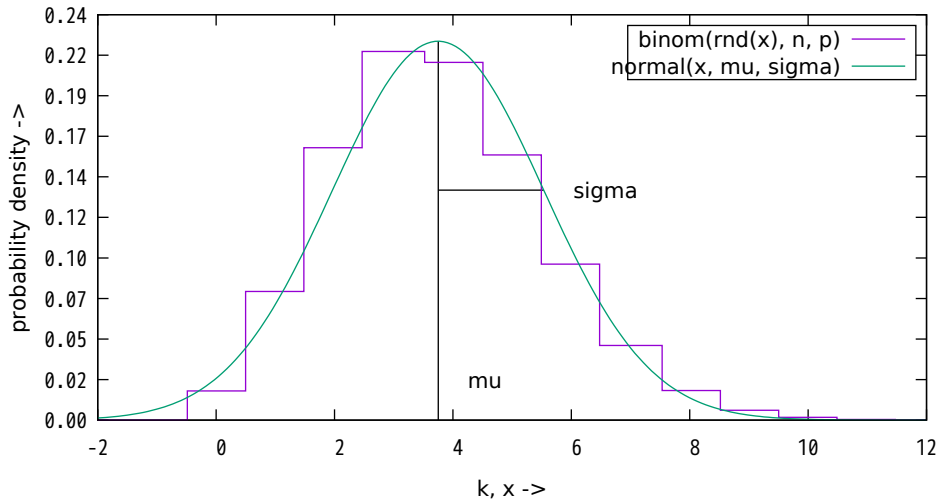

binomial PDF using poisson approximation

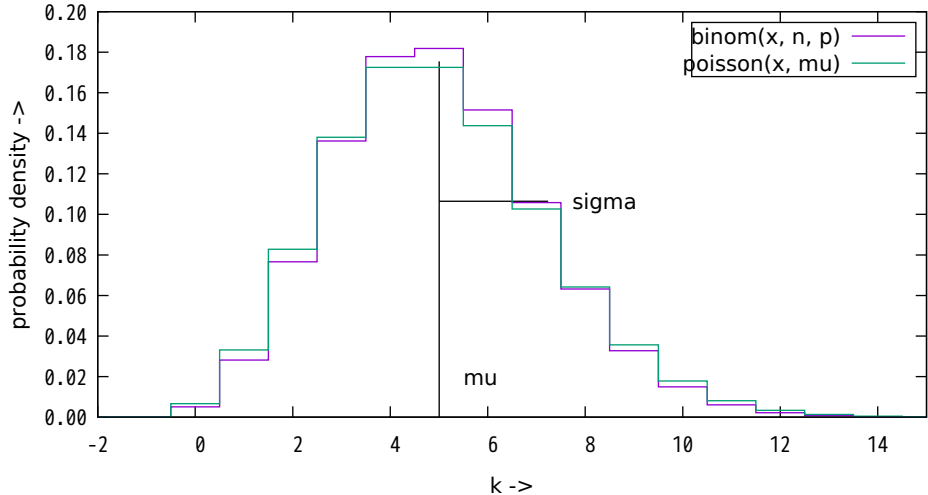

geometric PDF using gamma approximation

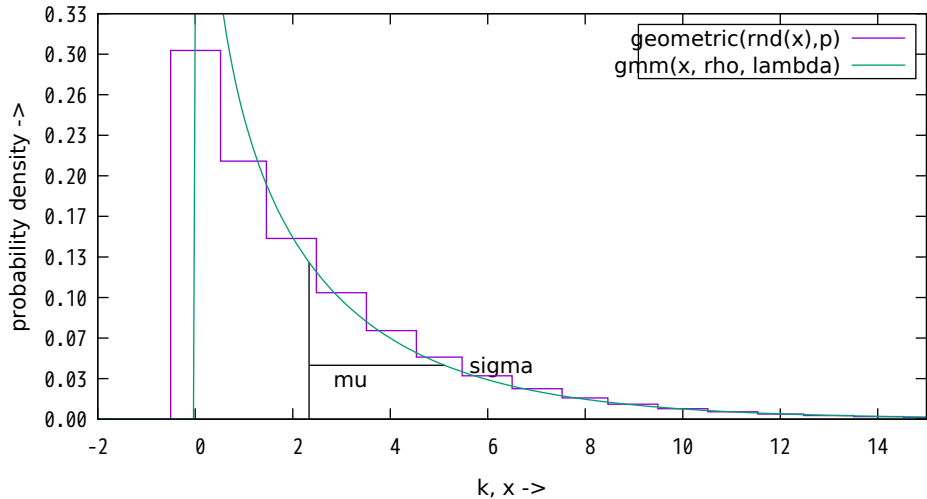

geometric PDF using normal approximation

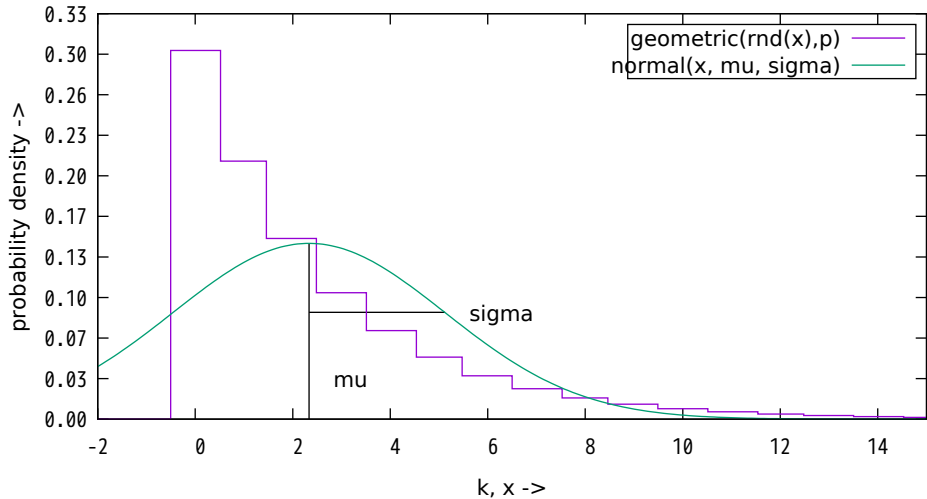

hypergeometric PDF using binomial approximation

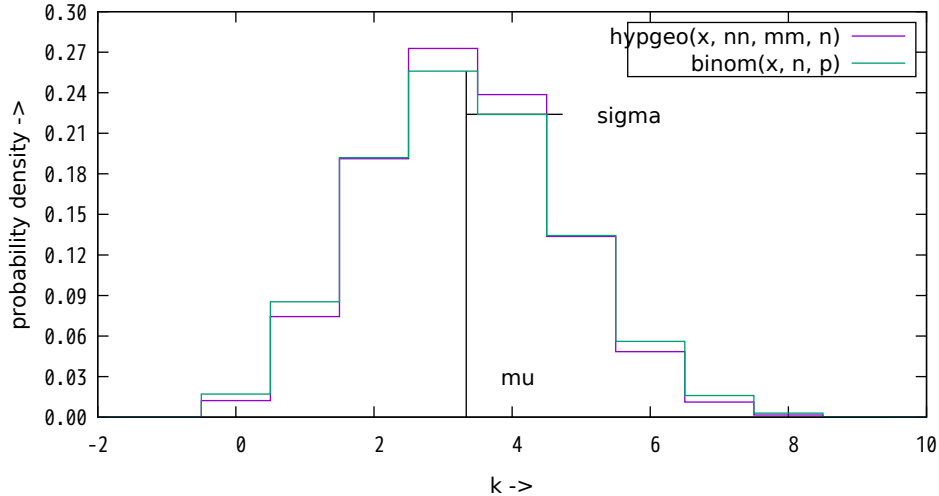

hypergeometric PDF using normal approximation

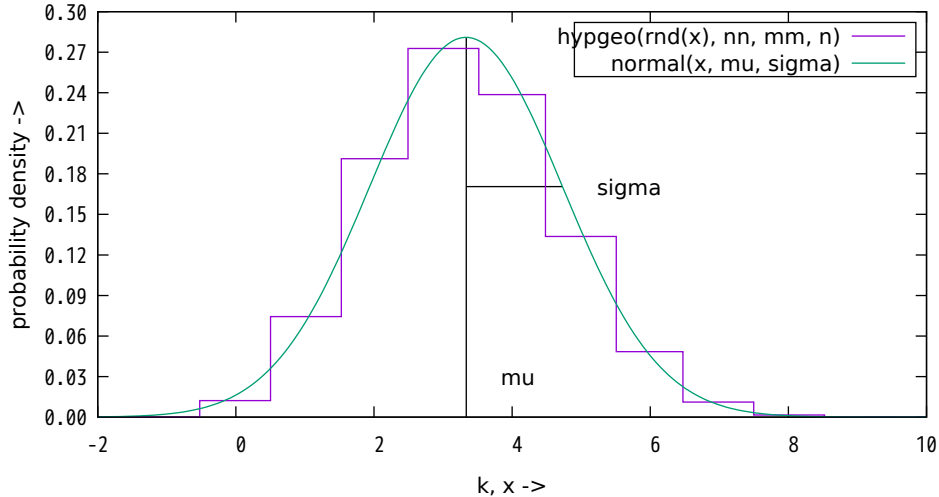

negative binomial PDF using gamma approximation

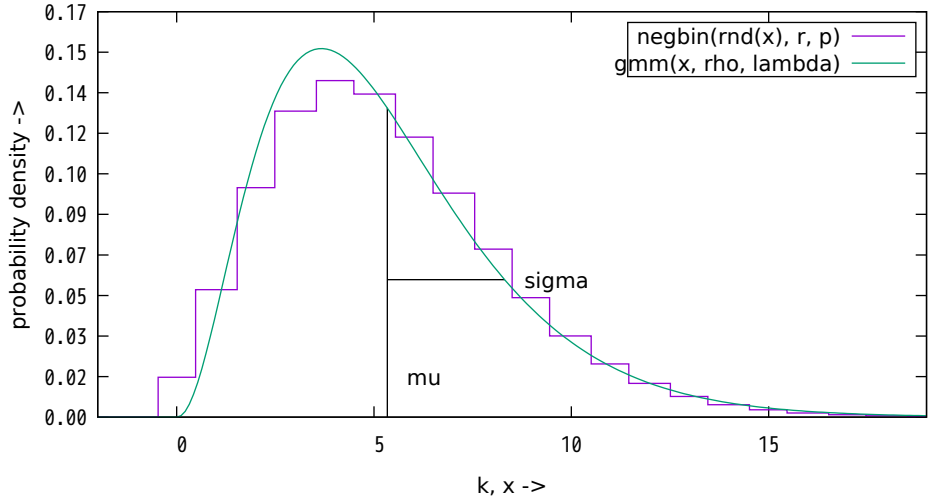



negative binomial PDF using normal approximation

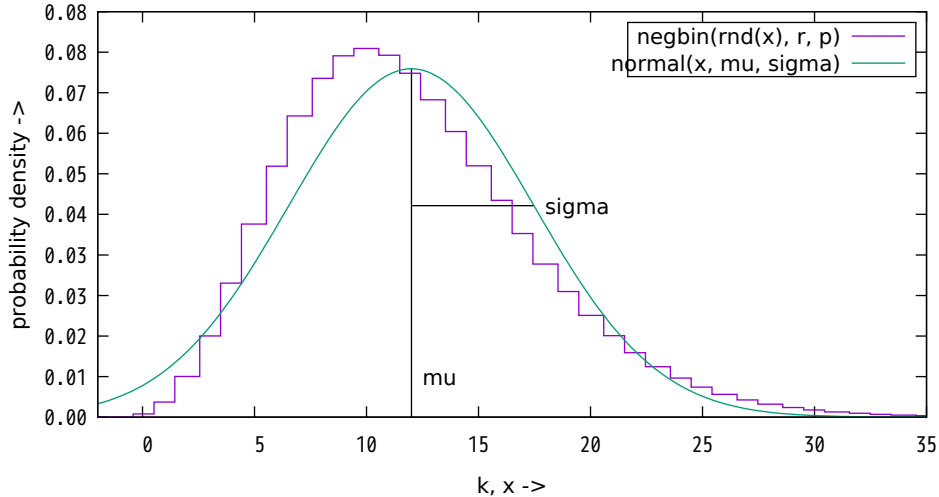

normal PDF using logistic approximation

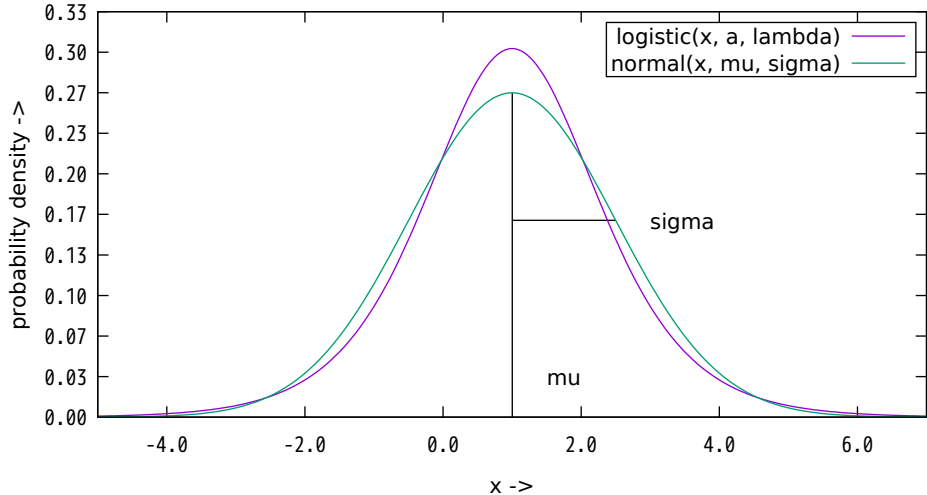

poisson PDF using normal approximation

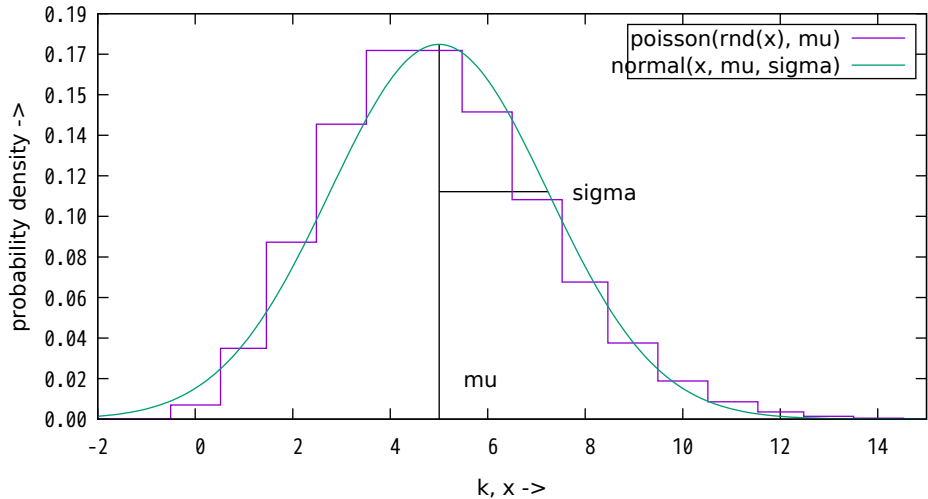

Lattice test for random numbers

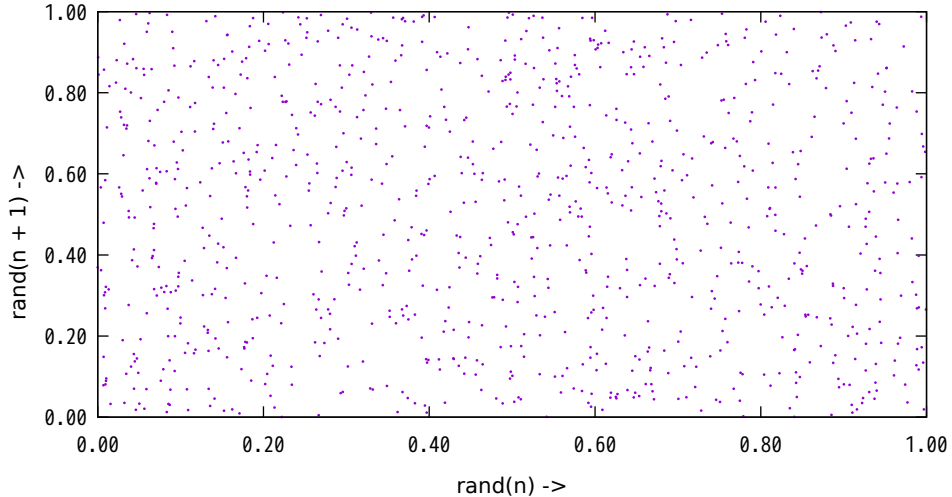

# Lattice test for random numbers

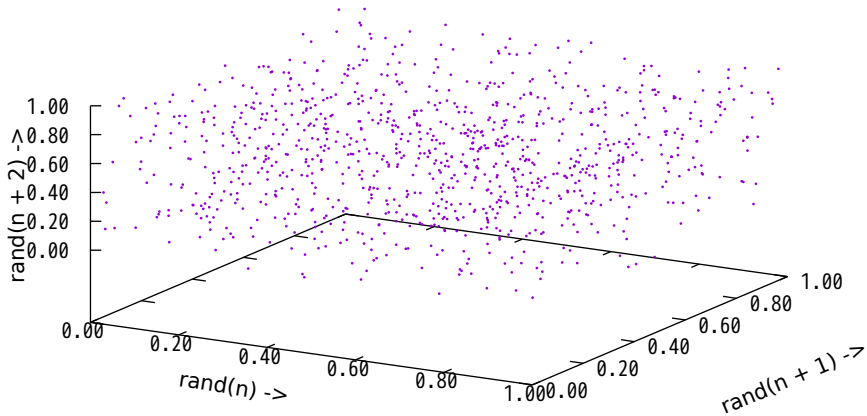

50 random samples from a 2D Gaussian PDF with unit variance, zero mean and no dependence

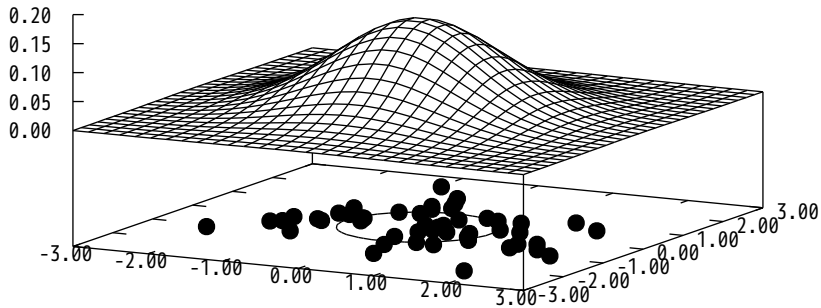

Histogram of 5000 random samples from a univariate Gaussian PDF with unit variance and zero mean

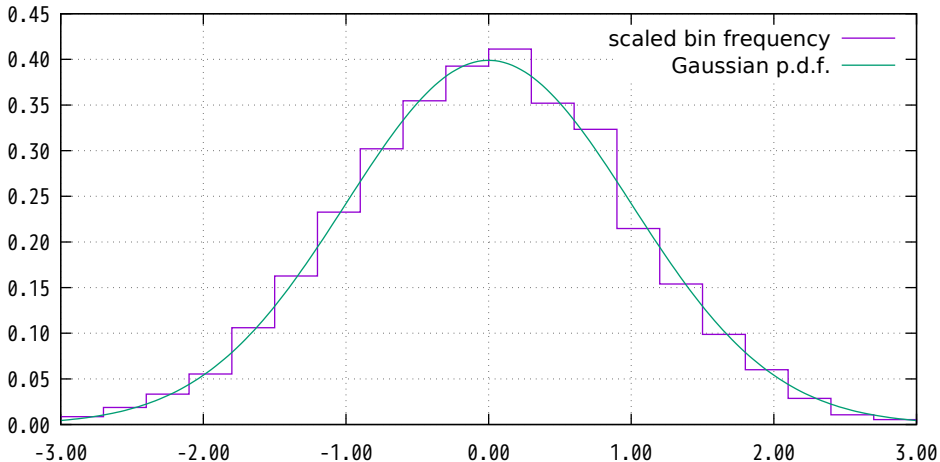

Gaussian 3D cloud of 3000 random samples      Histogram of distance from origin of 3000 multivariate unit variance samples

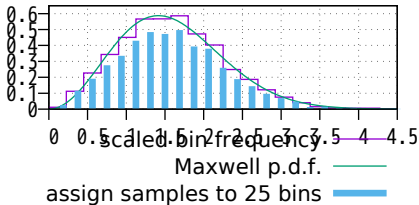
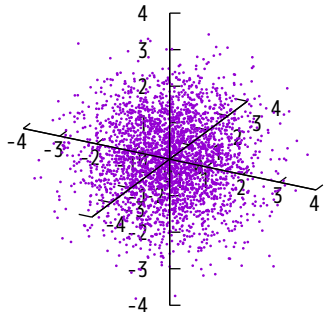



# Rug Plot

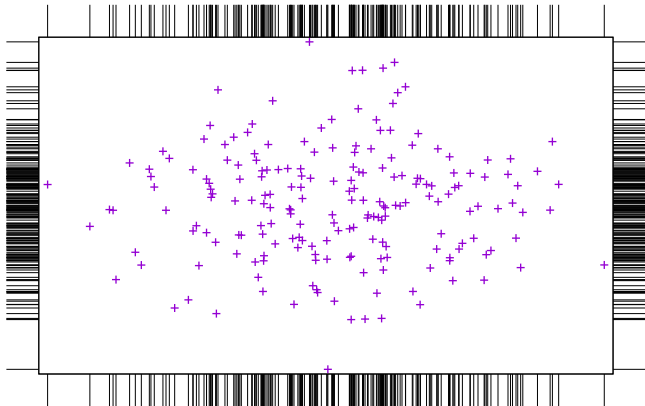

# Uniform Distribution

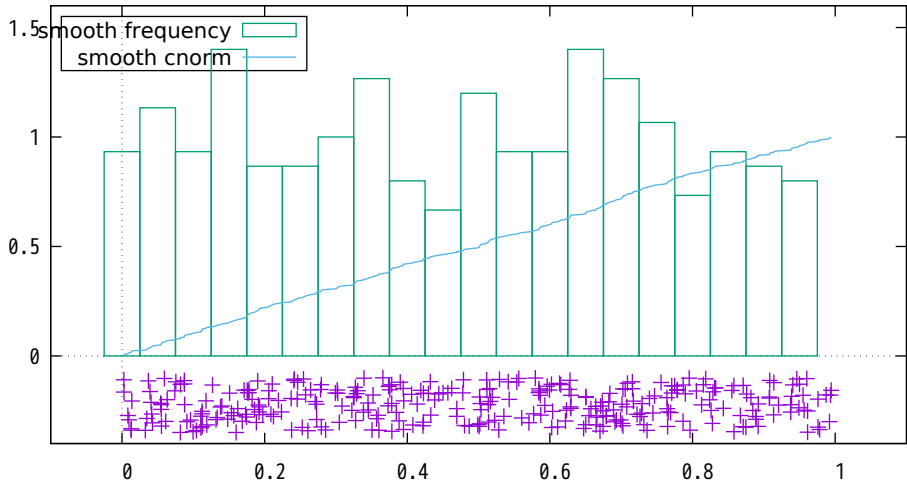

# Normal Distribution

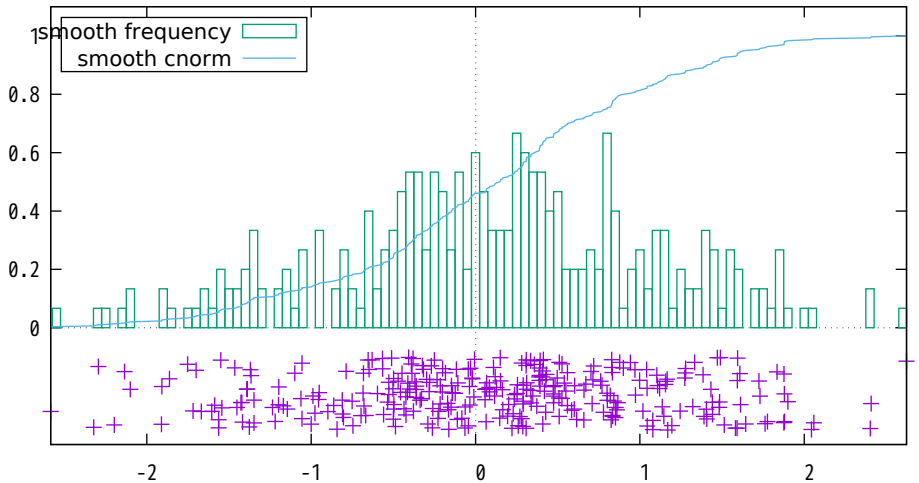

# Lognormal Distribution

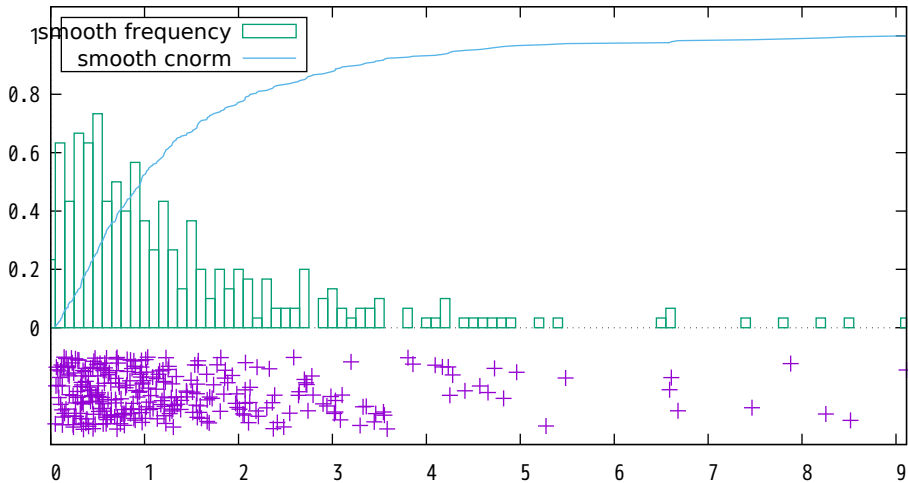

Mixed Distribution (Lognormal with shifted Gaussian)

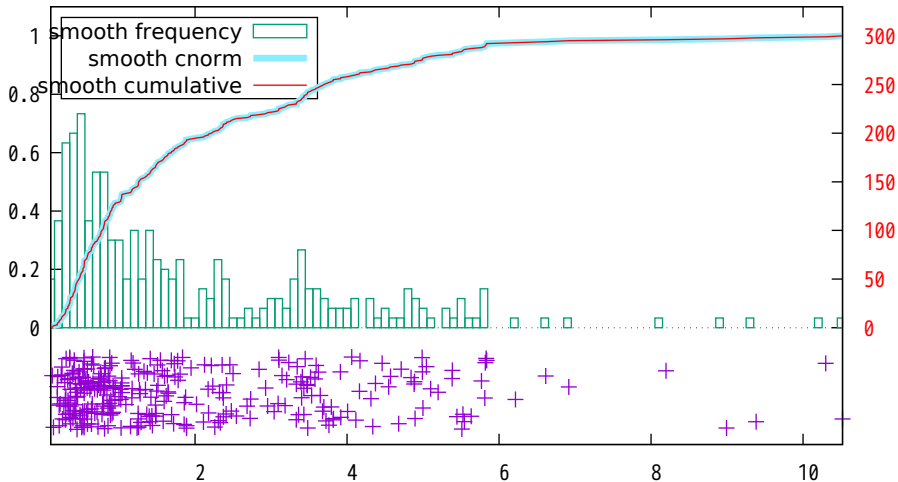

The cubic Monomial basis functions

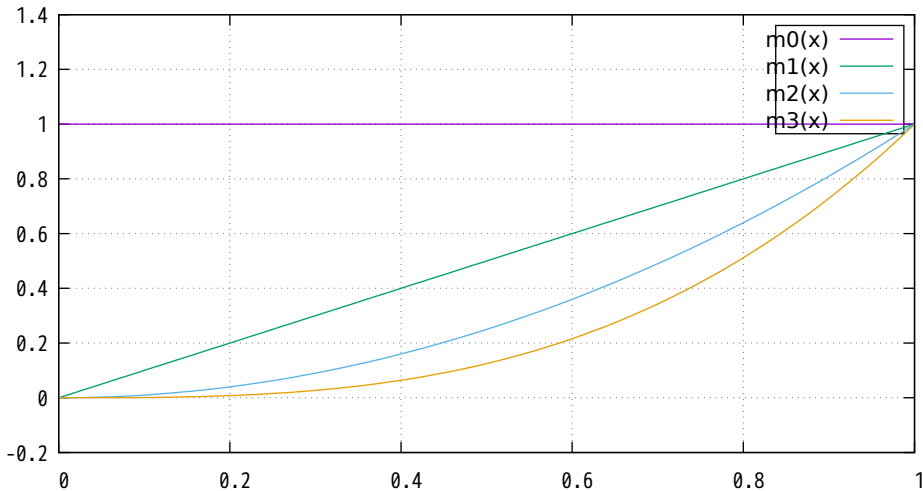

The cubic Hermite basis functions

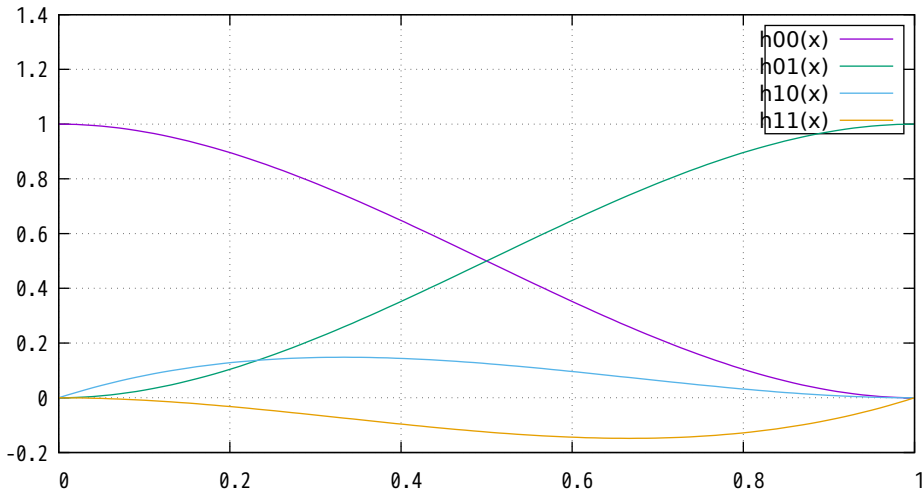

The cubic Bezier basis functions

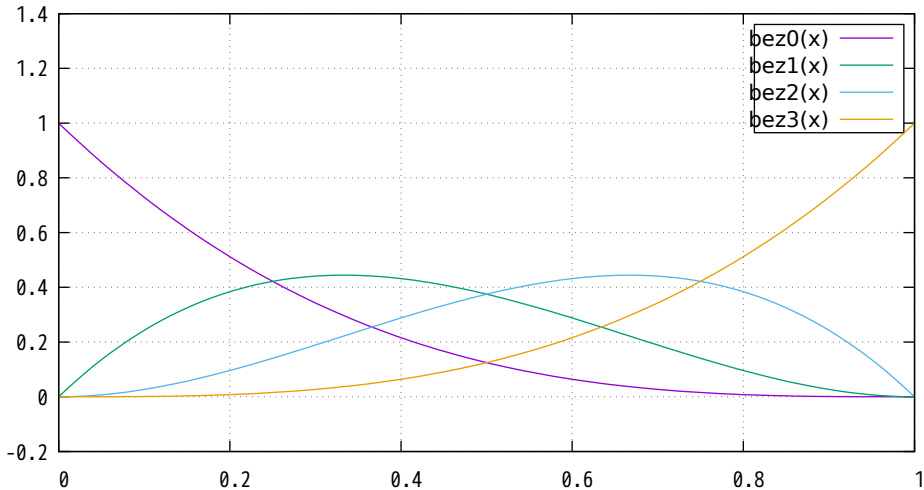



The cubic uniform B-spline basis functions

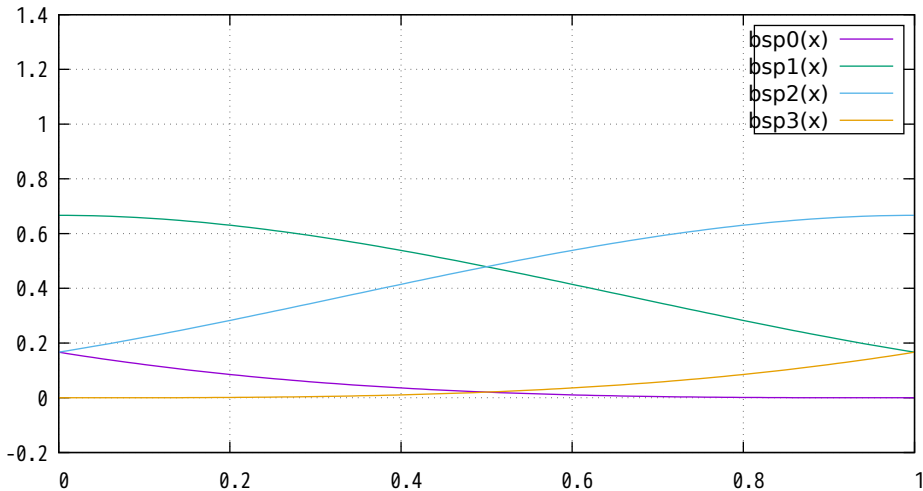

The cubic Bezier/Bspline basis functions in use

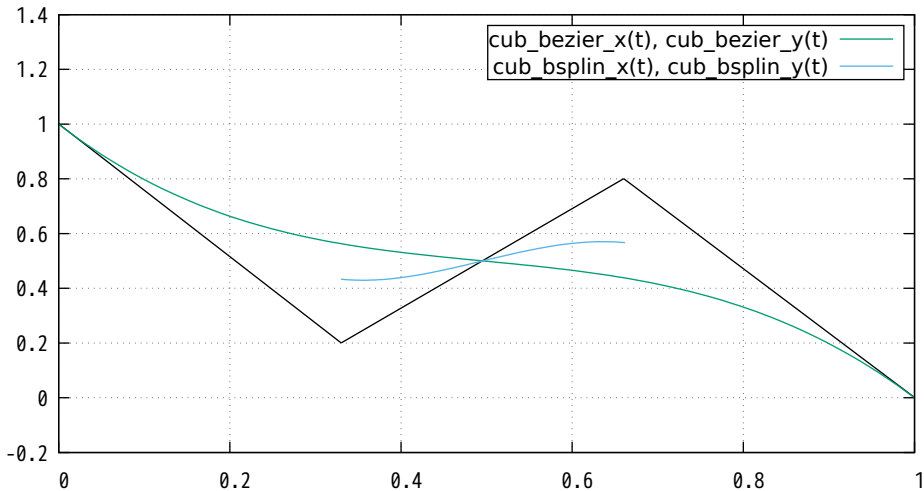

The cubic Hermite basis functions in use

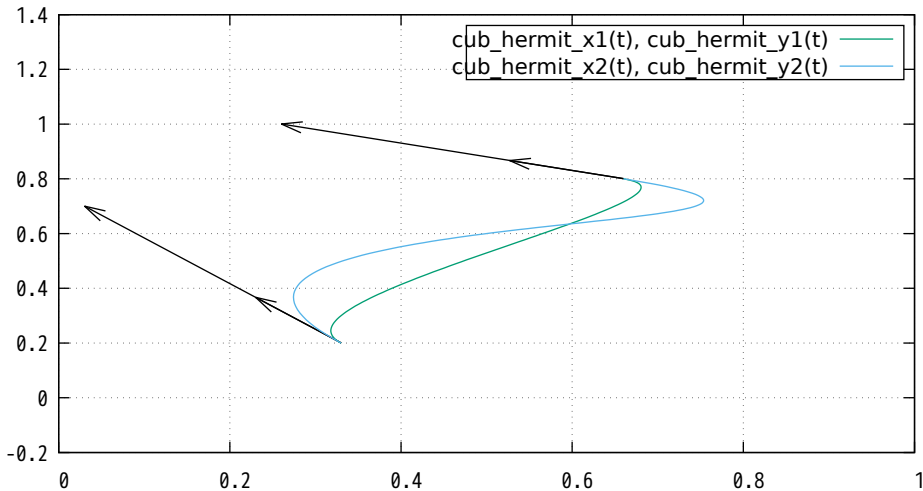

# Hidden line removal of explicit binary surfaces

"binary1" binary 

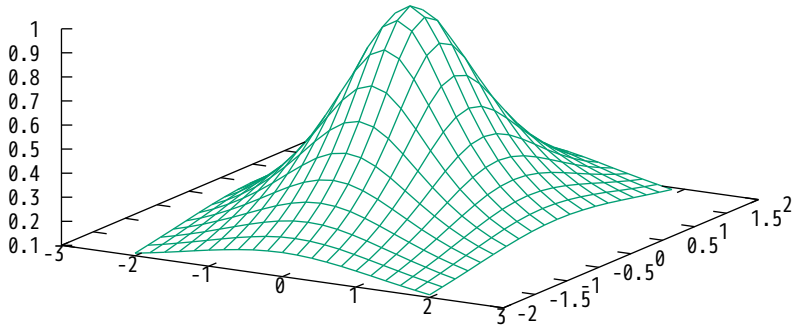

# Hidden line removal of explicit binary surfaces

"binary2" binary 

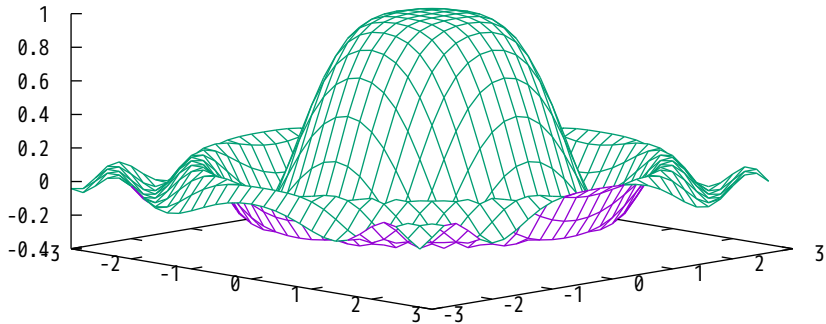

Notice that sampling rate can change

"binary3" binary 

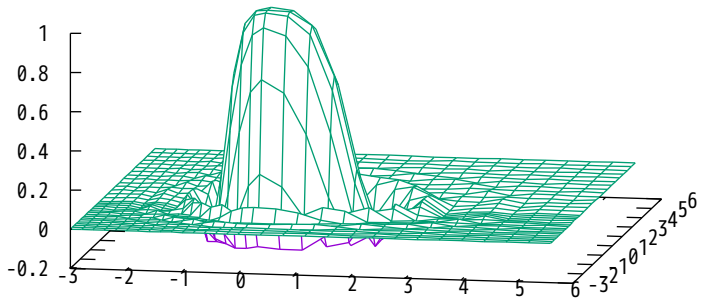

Compare steps, fsteps and histeps

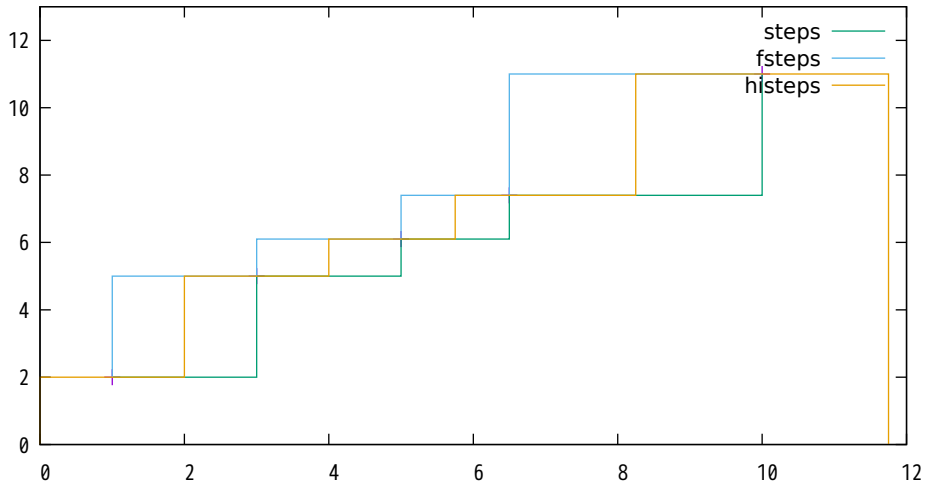

Histogram built from unsorted data by 'smooth frequency'

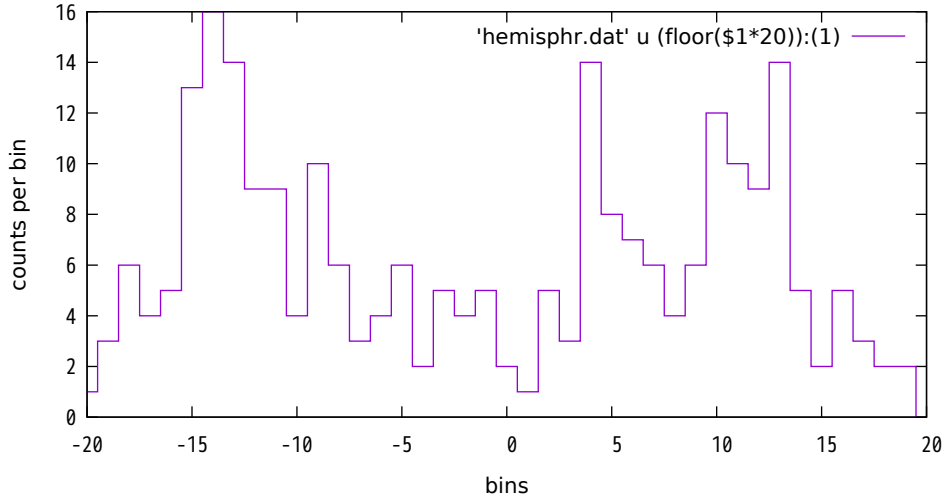



Normal Distribution Function

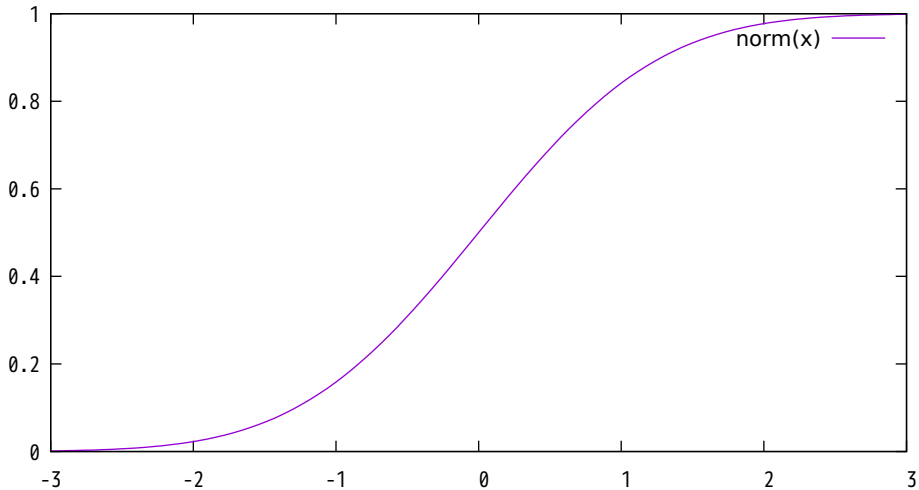

# Inverse Error Function

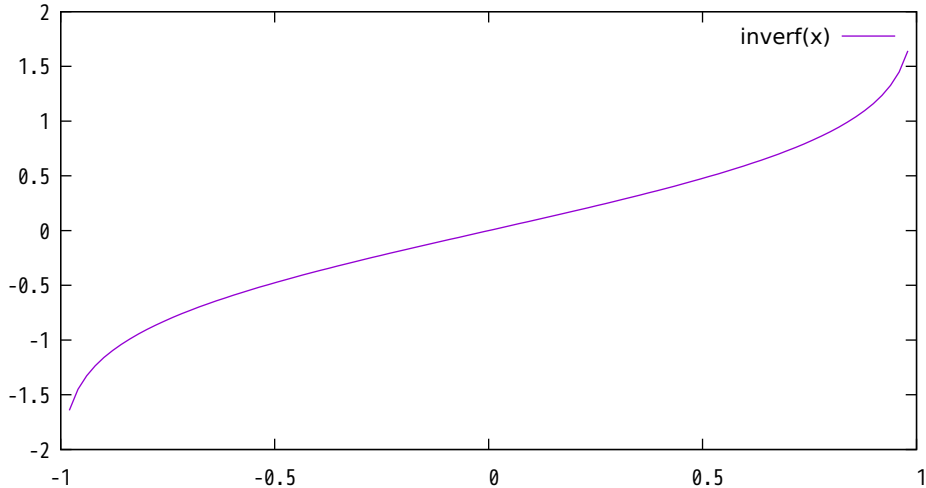

Inverse Normal Distribution Function

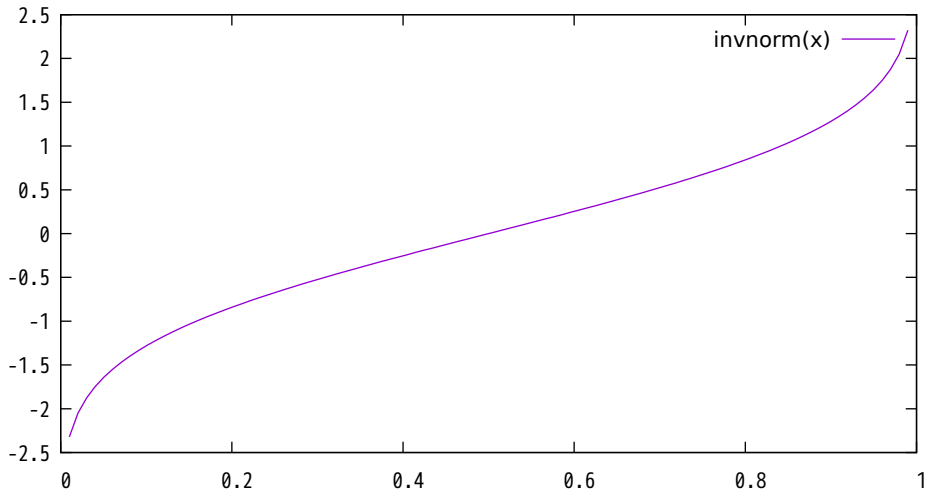

# Simple demo of scatter data conversion to grid data

"hemisphr.dat" +

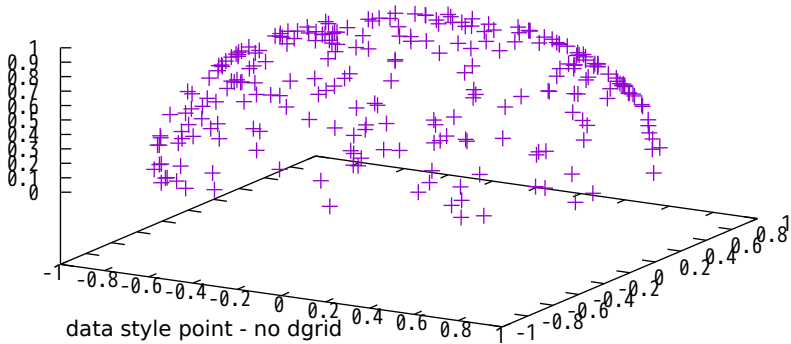

# Simple demo of scatter data conversion to grid data

"hemisphr.dat" —

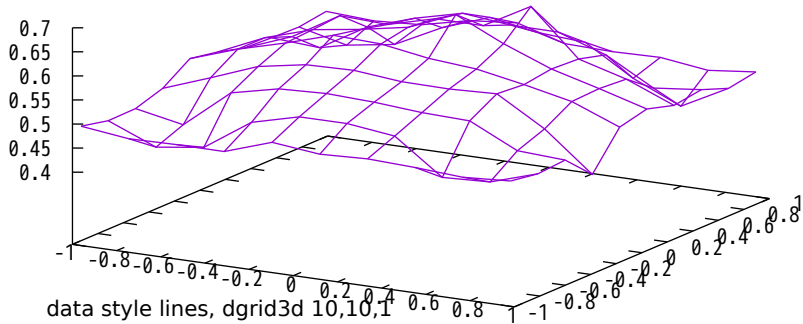

# Simple demo of scatter data conversion to grid data

"hemisphr.dat" —

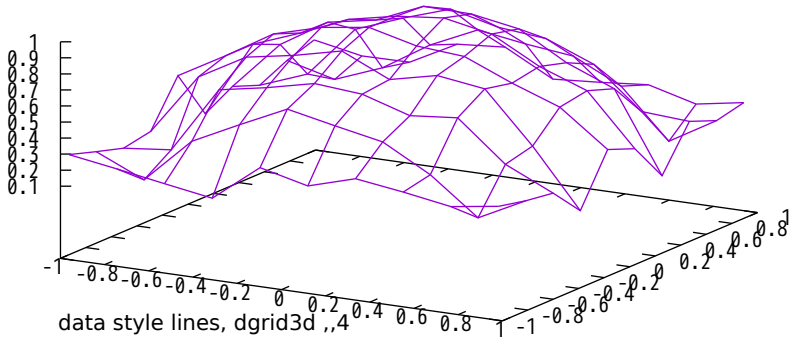

# Simple demo of scatter data conversion to grid data

"hemisphr.dat" —

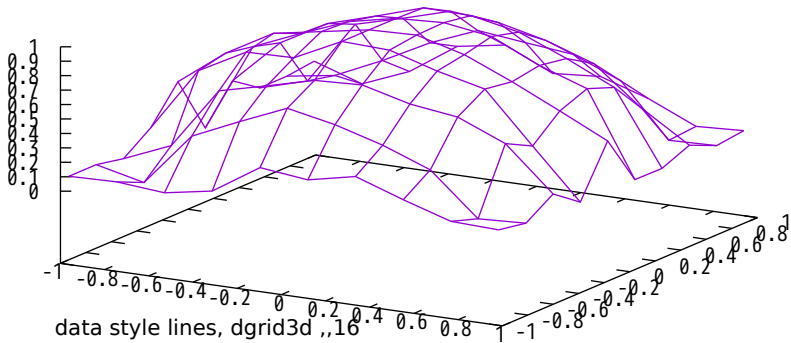

# Simple demo of scatter data conversion to grid data

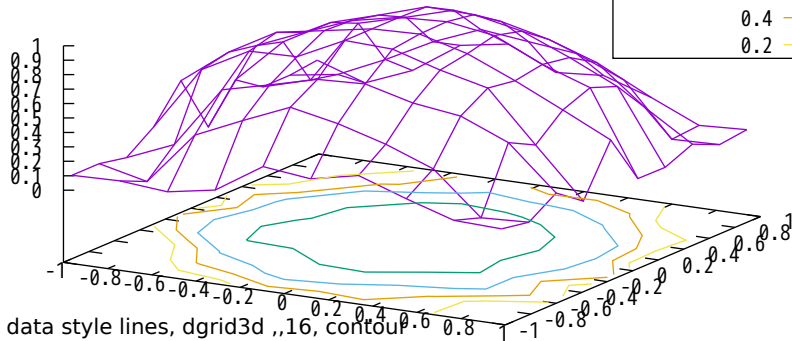
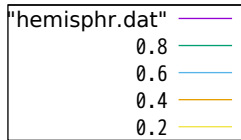



# Simple demo of scatter data conversion to grid data

"scatter2.dat" +

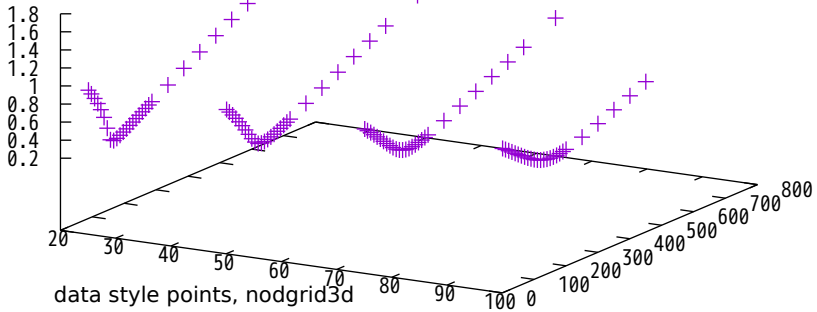

# Simple demo of scatter data conversion to grid data

"scatter2.dat" — purple  
1.5 — green  
1 — blue  
0.5 — orange

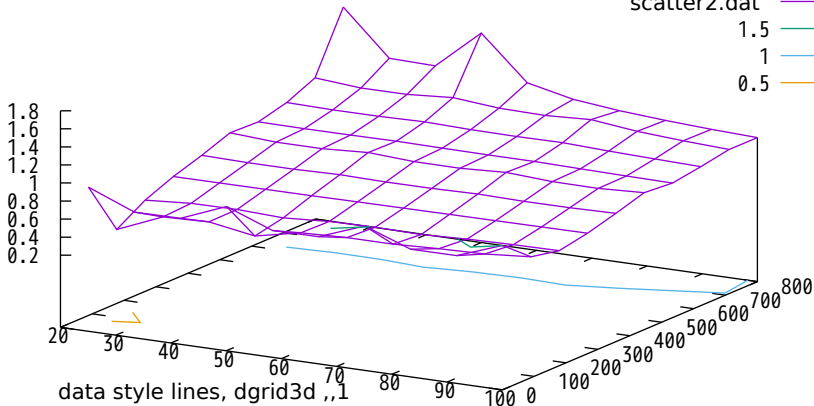

# Simple demo of scatter data conversion to grid data

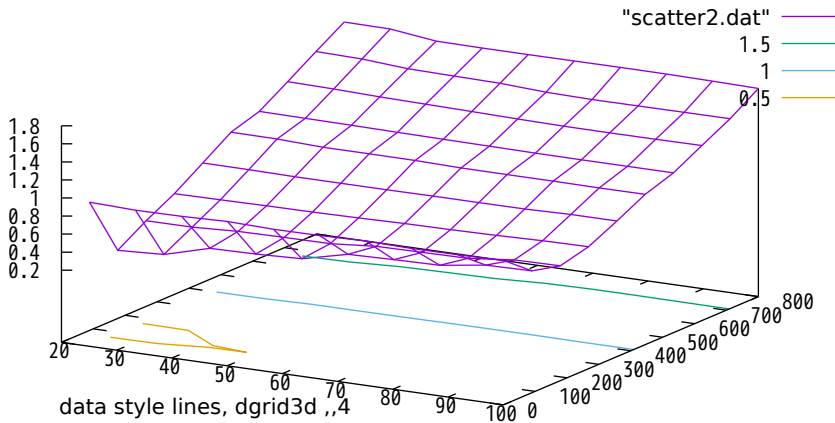

# Real part of complex square root function

$$u^2 - v^2, 2uv, u$$

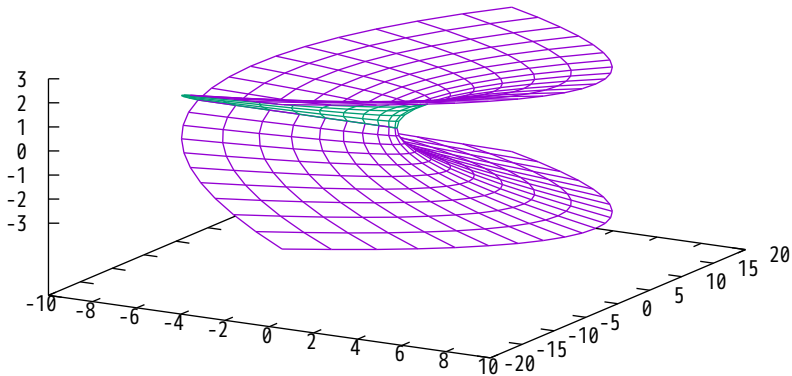

# Real part of complex square root function (different view)

$$u^2 - v^2, 2uv, u$$

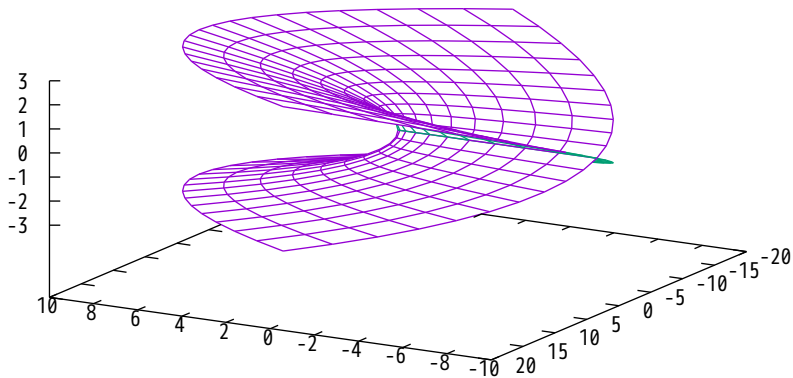

# Imaginary part of complex square root function

$$u^2 - v^2, 2uv, v$$

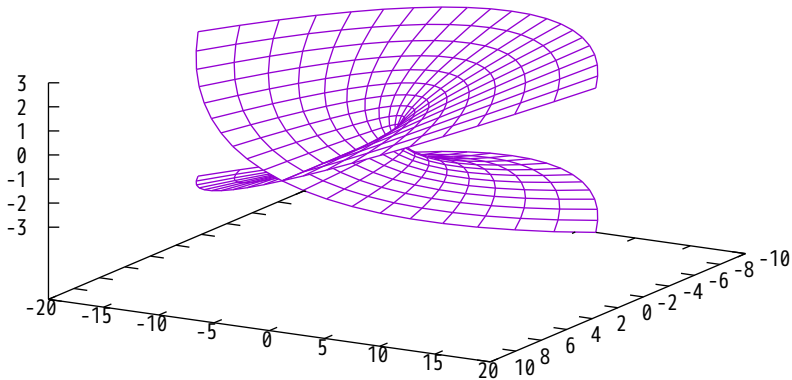

Imaginary part of complex square root function (different view)

$$u^2 - v^2, 2uv, v$$

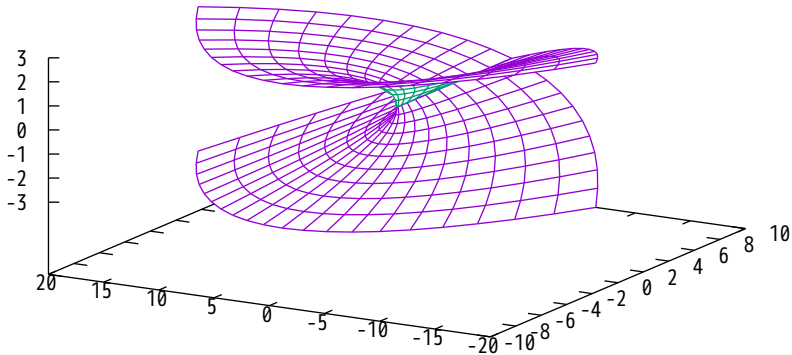

# Real part of complex cube root function

$$u^3 - 3uv^2, 3u^2v - v^3, u$$

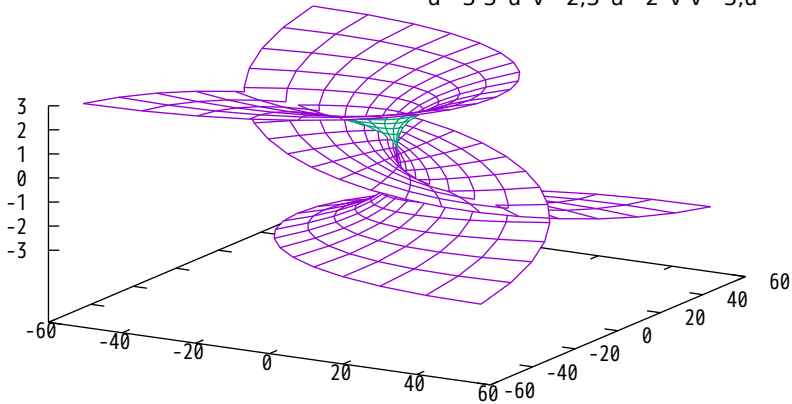



Real part of complex cube root function (different view)

$$u^3 - 3uv^2, 3u^2v - v^3, u$$

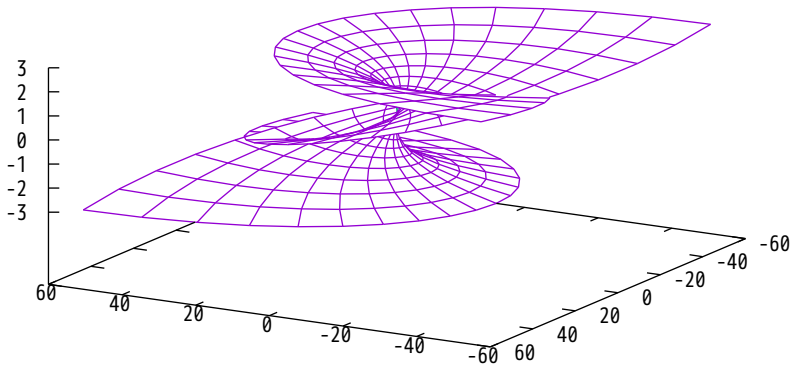

# Imaginary part of complex cube root function

$$u^3 - 3uv^2, 3u^2v - v^3, v$$

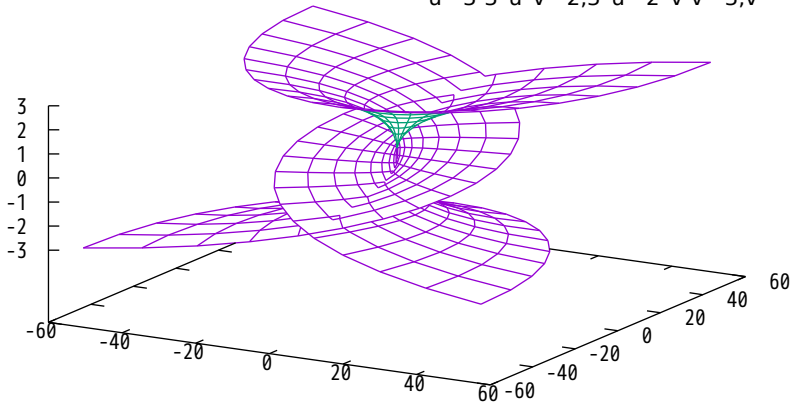

Imaginary part of complex cube root function (different view)

$$u^3 - 3uv^2, 3u^2v - v^3, v$$

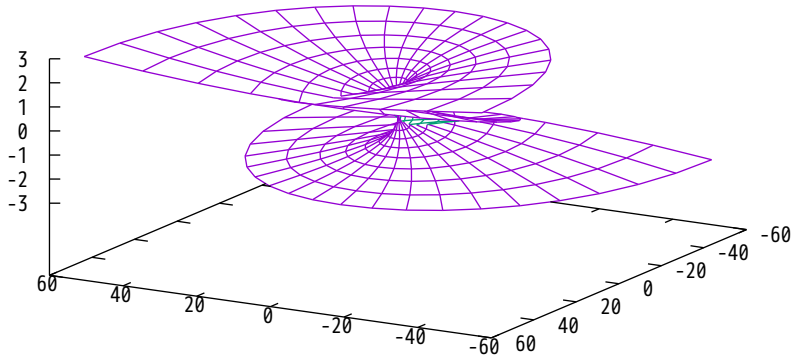

Real part of complex 4th root function

$$u^{**4}-6*u^{**2}*v^{**2}+v^{**4}, 4*u^{**3}*v-4*u*v^{**3}, u$$

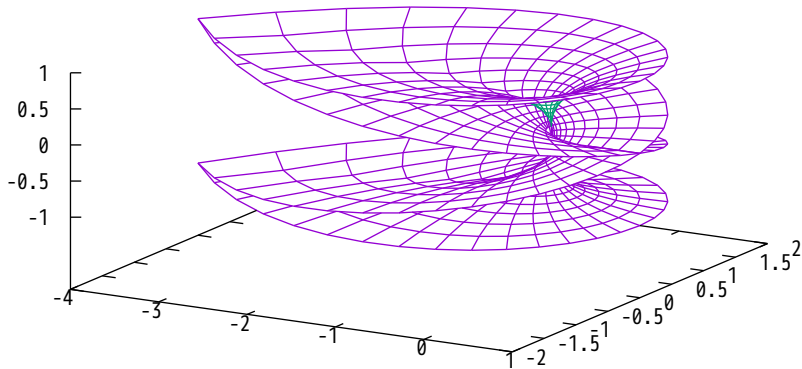

Real part of complex 4th root function (different view)

$$u^{**4}-6*u^{**2}*v^{**2}+v^{**4},4*u^{**3}*v-4*u*v^{**3},u$$

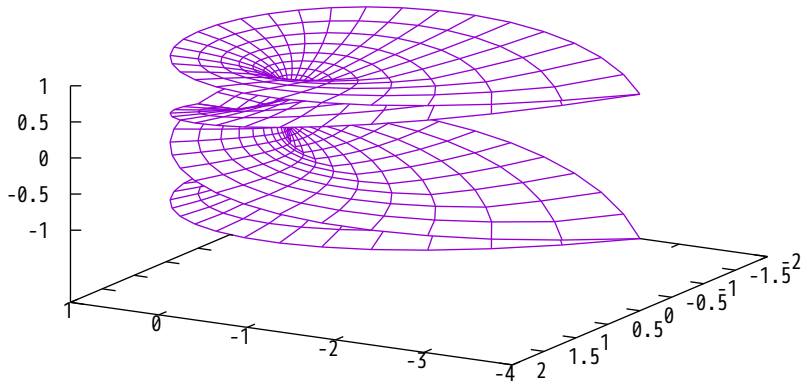

Imaginary part of complex 4th root function

$$u^{**4}-6*u^{**2}*v^{**2}+v^{**4},4*u^{**3}*v-4*u*v^{**3},v$$

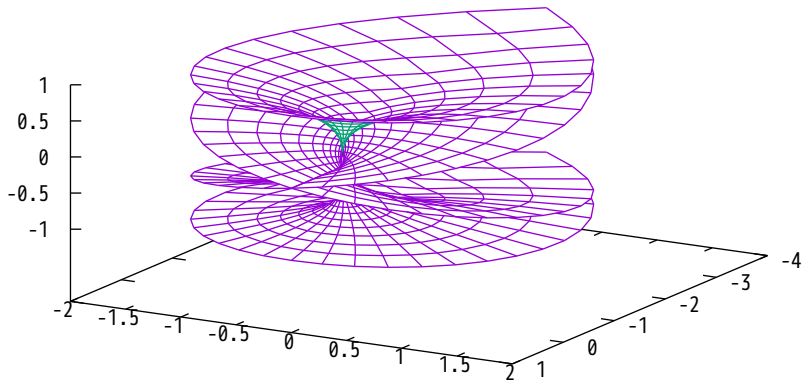

Imaginary part of complex 4th root function (different view)

$$u^{**4}-6*u^{**2}*v^{**2}+v^{**4}, 4*u^{**3}*v-4*u*v^{**3}, v$$

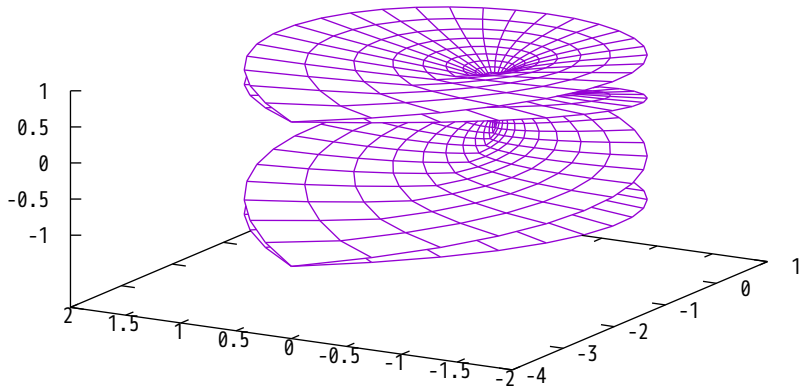

# Enneper's surface

$$u - \frac{u^3}{3} + u \cdot v^2, v - \frac{v^3}{3} + v \cdot u^2, u^2 - v^2$$

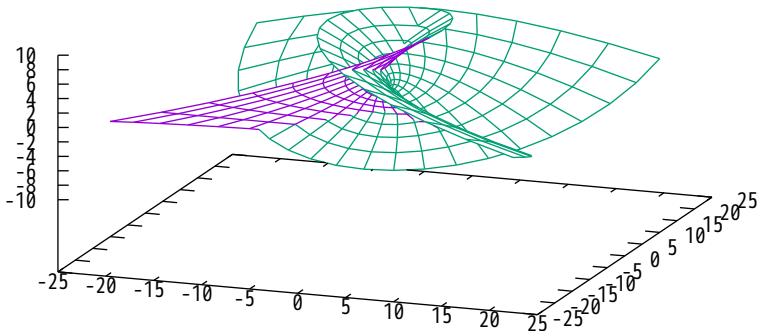



# Enneper's surface (different view)

$$u - \frac{u^3}{3} + u \cdot v^2, v - \frac{v^3}{3} + v \cdot u^2, u^2 - v^2$$

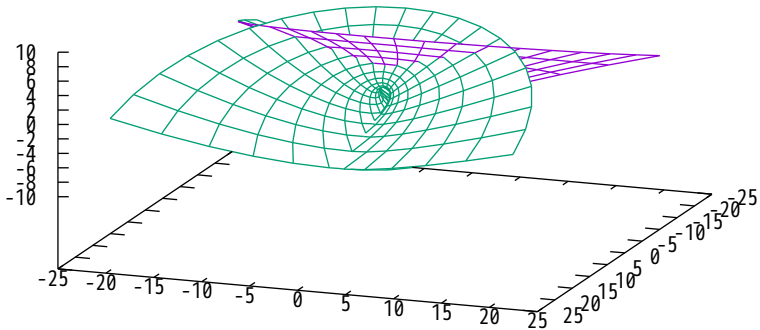

# Moebius strip

$$(2-v*\sin(u/2))*\sin(u), (2-v*\sin(u/2))*\cos(u), v*\cos(u/2)$$

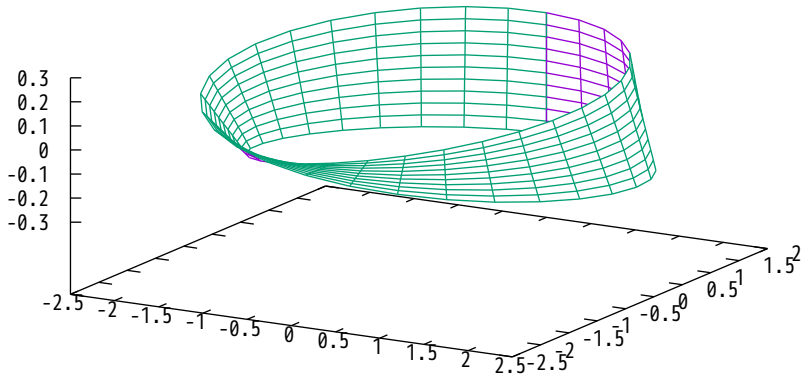

Moebius strip (view from opposite side)

$$(2-v*\sin(u/2))*\sin(u), (2-v*\sin(u/2))*\cos(u), v*\cos(u/2)$$

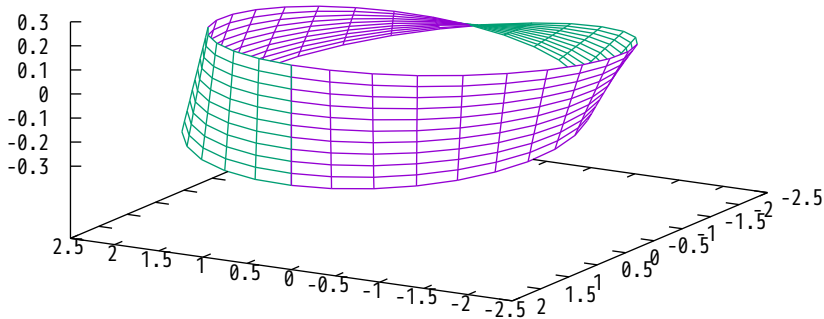

Klein bottle

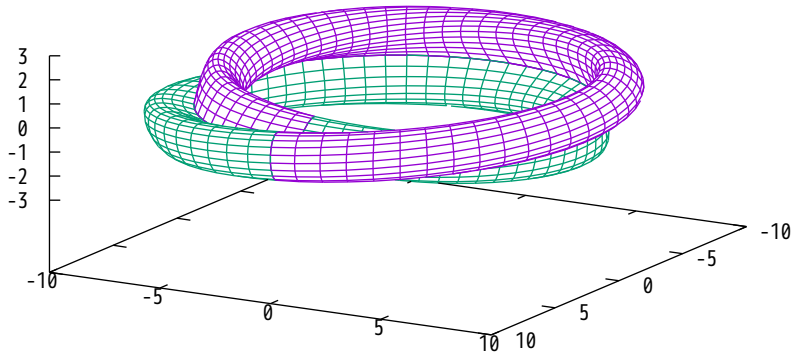

Klein bottle with look at the 'inside'

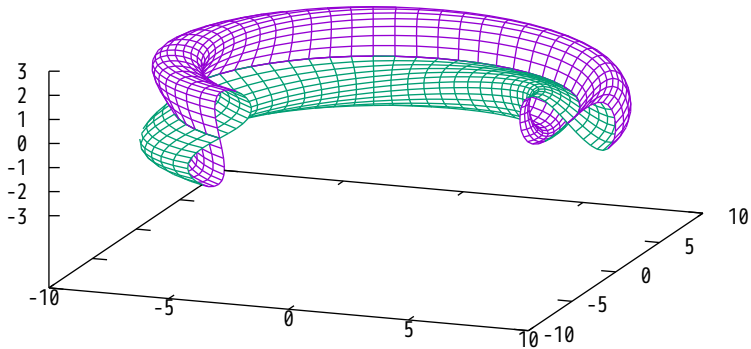

Klein bottle, glassblowers' version (look-through)

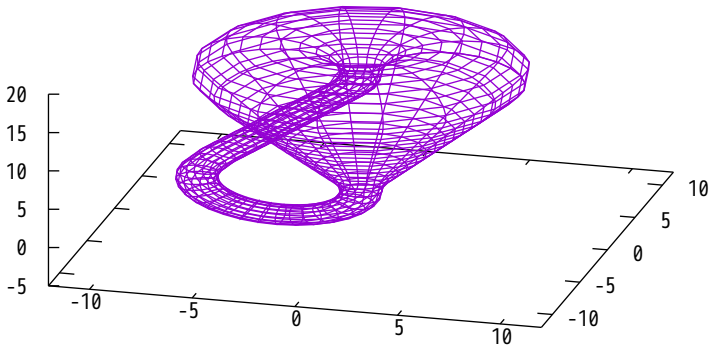

Klein bottle, glassblowers' version (solid)

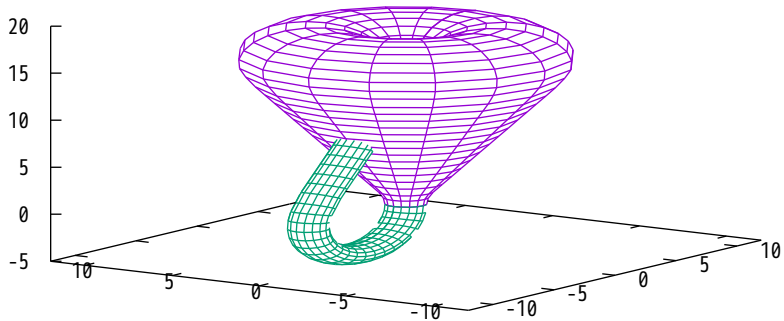

# NACA6409 Airfoil

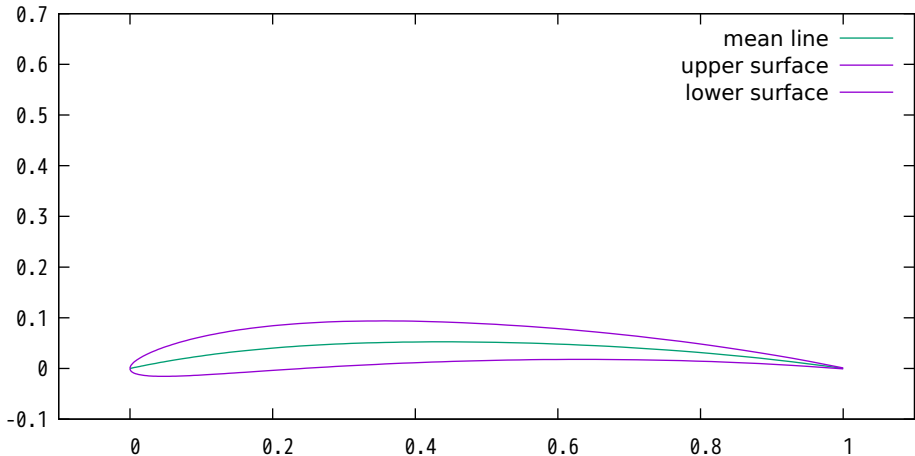

NACA6409 -- 9% thick, 40% max camber, 6% camber



# NACA0012 Airfoil

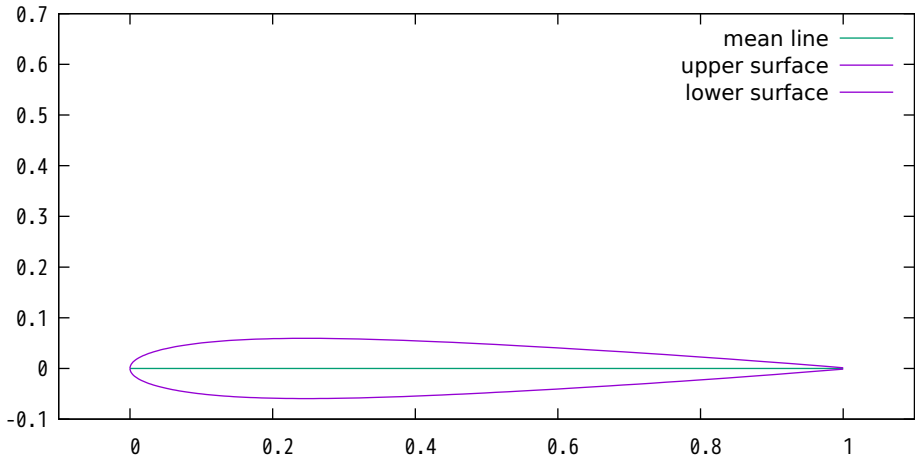

12% thick, no camber -- classical test case

# Joukowski Airfoil using Complex Variables

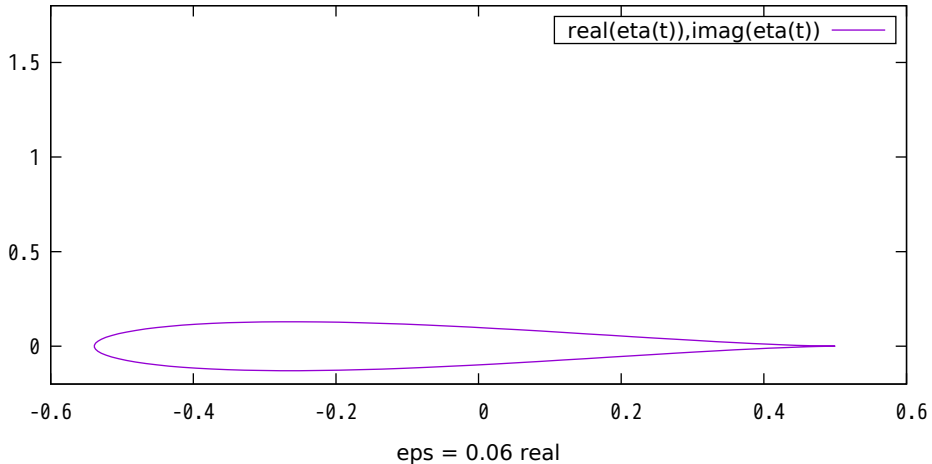

# Joukowski Airfoil using Complex Variables

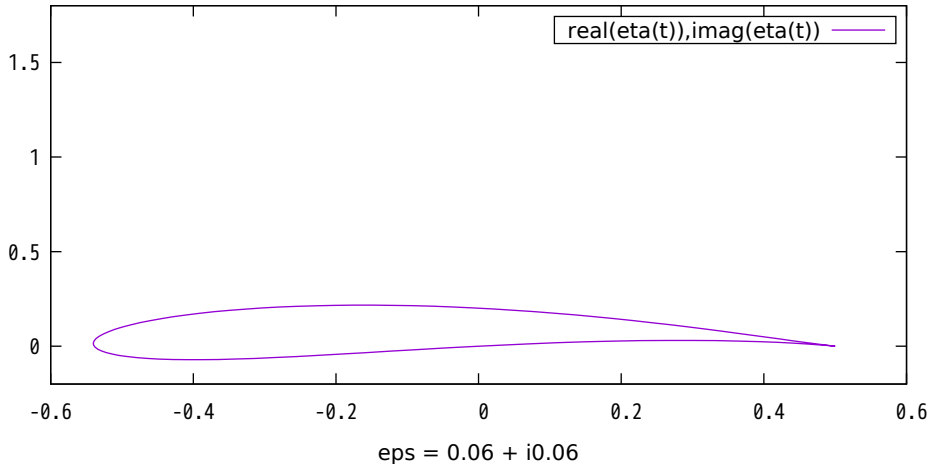

# Parametric Sphere

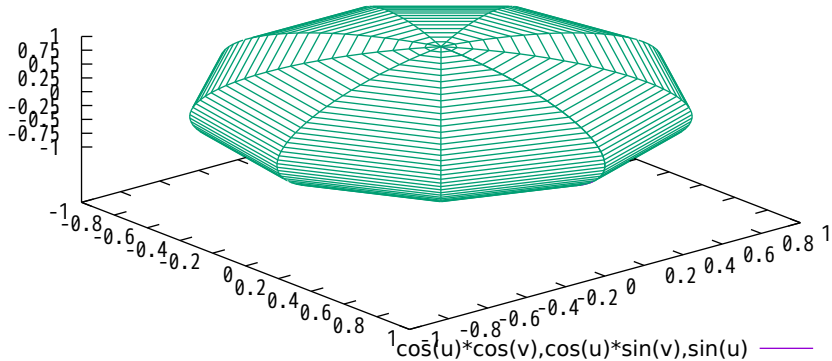

# Parametric Sphere, crunched z axis

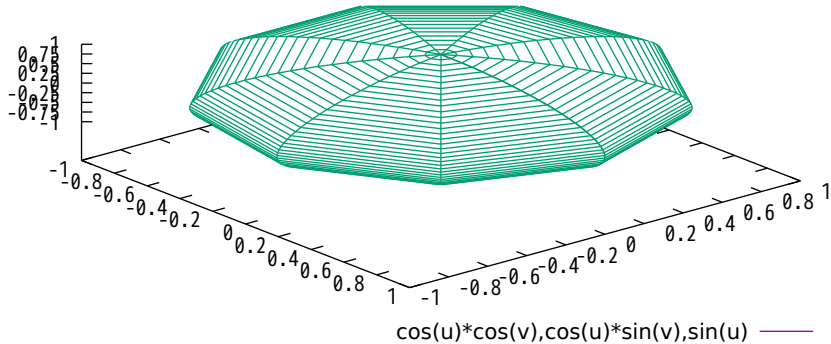

Parametric Sphere, enlarged z axis

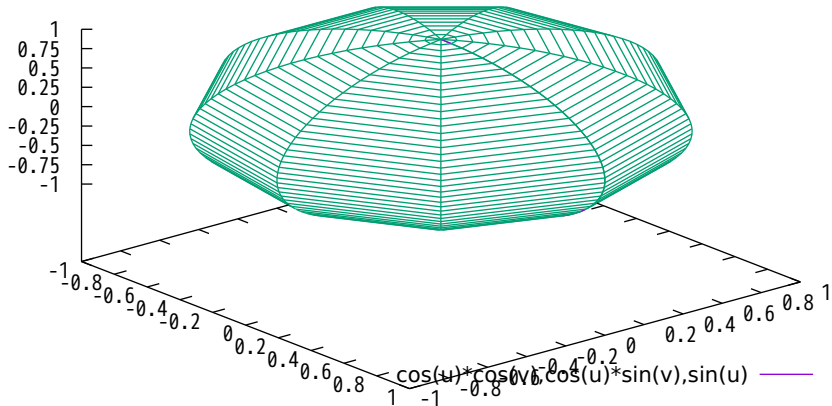

# Parametric Torus

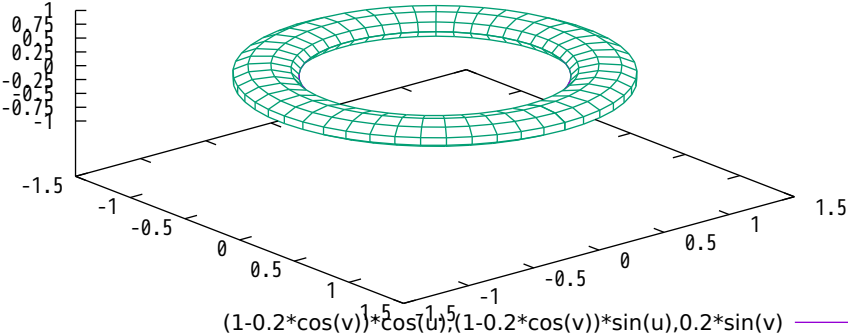

## Parametric Hexagon

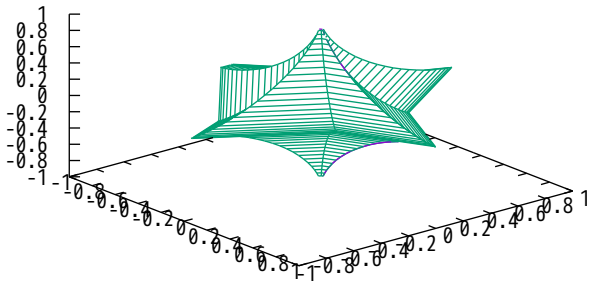

$$\cos(v)**3*\cos(u)**3,\sin(v)**3*\cos(u)**3,\sin(u)**3$$



## Parametric Helix

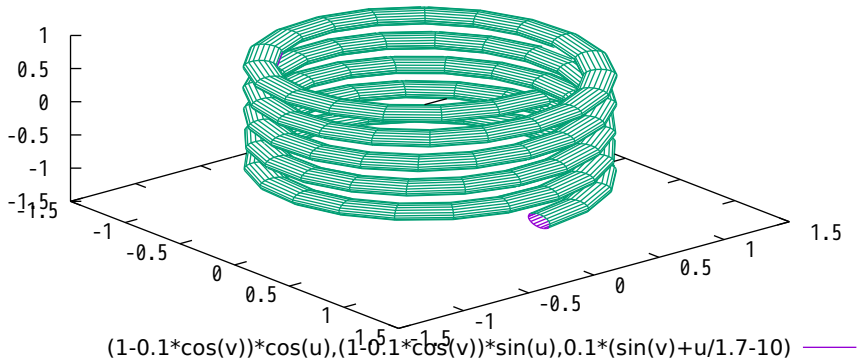

# Parametric Shell (clipped to limited z range)

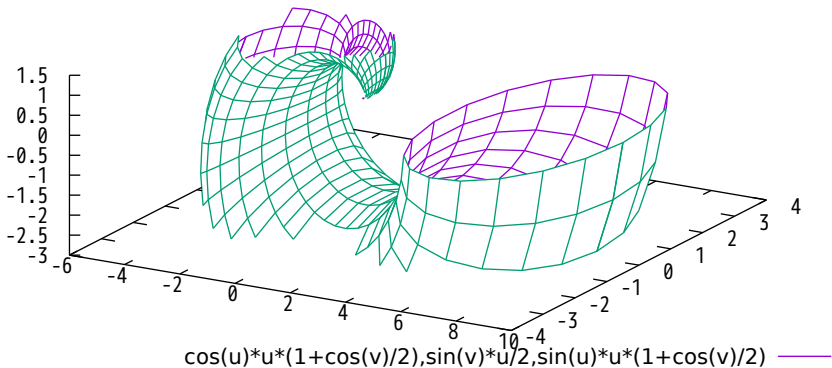

# Parametric Shell (automatic z range)

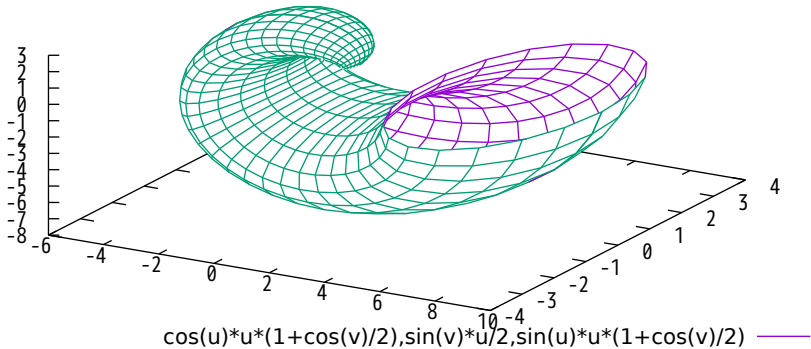

## Interlocking Tori

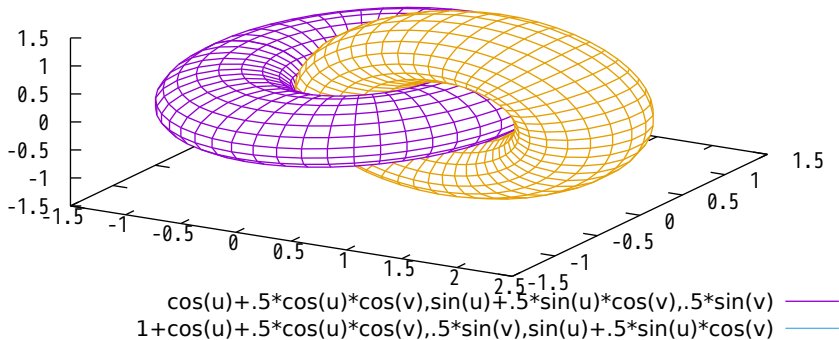

azimuth 0

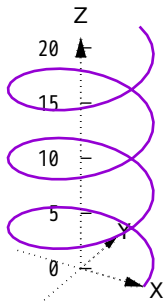

azimuth 10

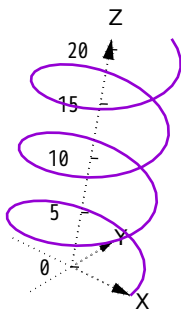

azimuth 60

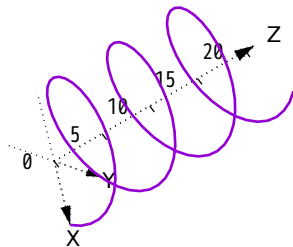

contour plot

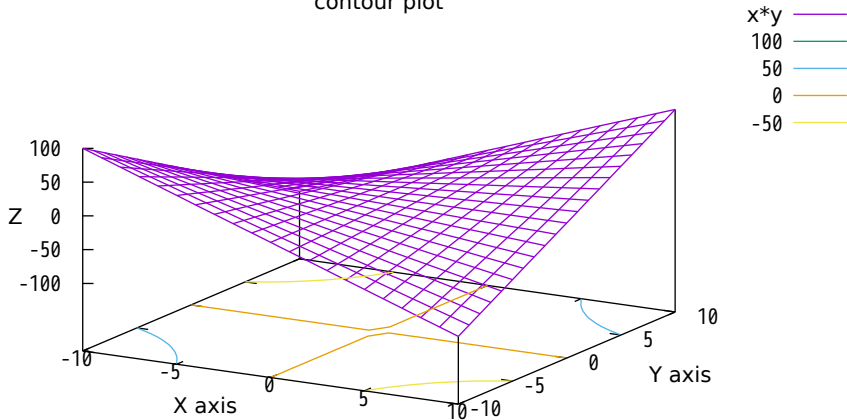

more contours (15 levels)

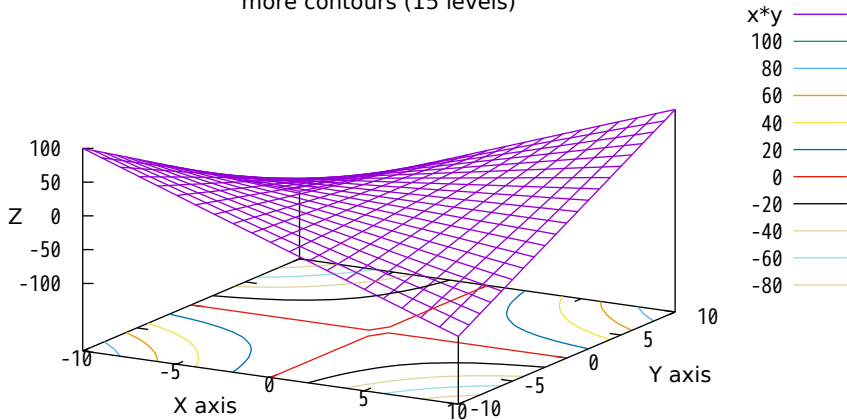

contour by increments (every 10, starting at -100)

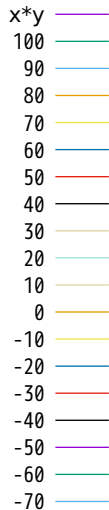
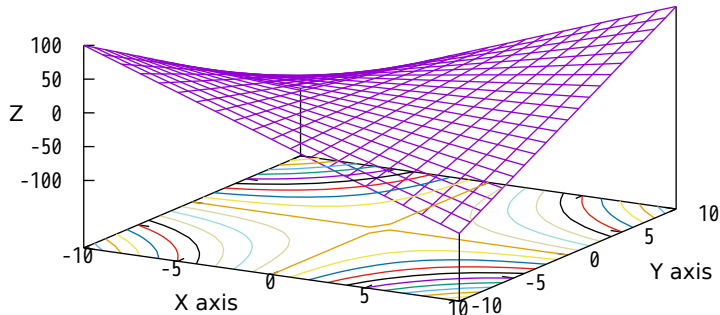



discrete set of contours (at -75, -50, 0)

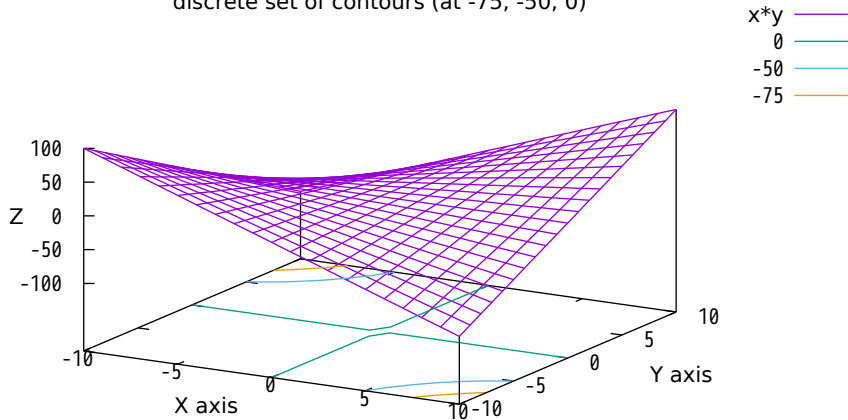

contours on base grid with labels

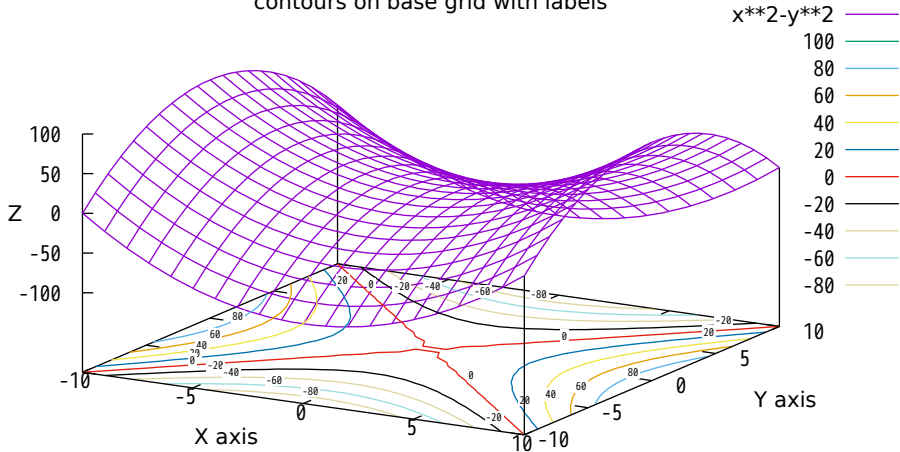

contours drawn on surface

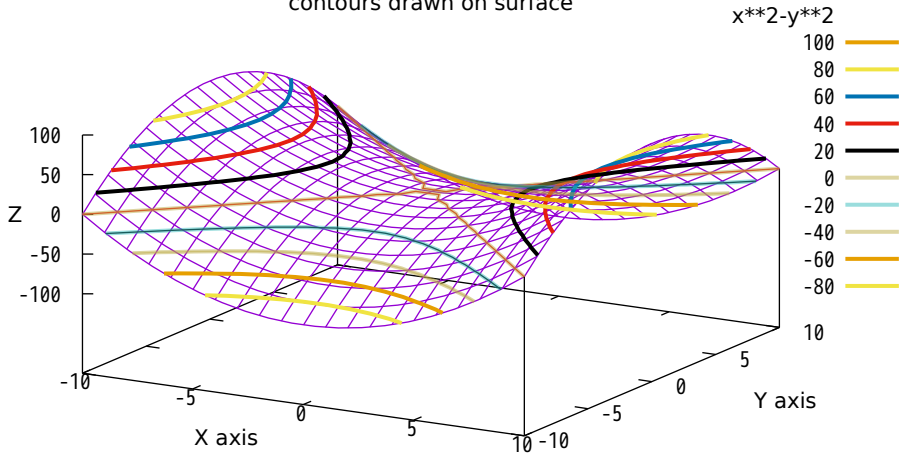

contours on both base and surface

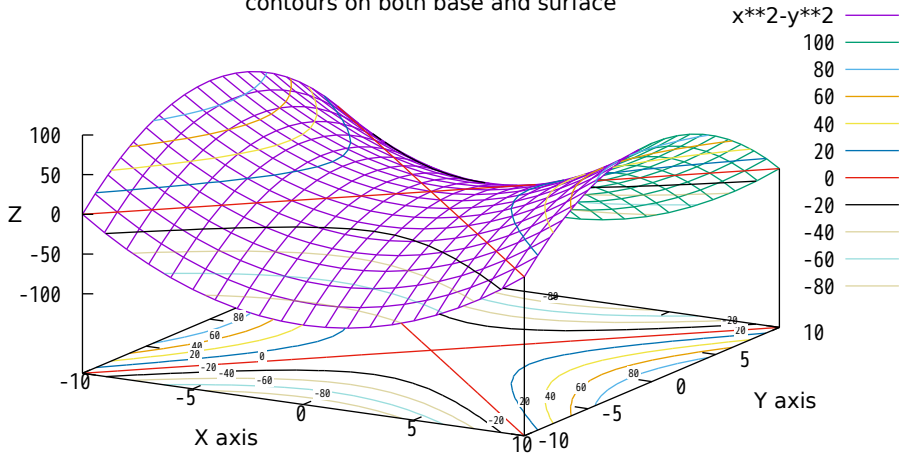

2 surfaces

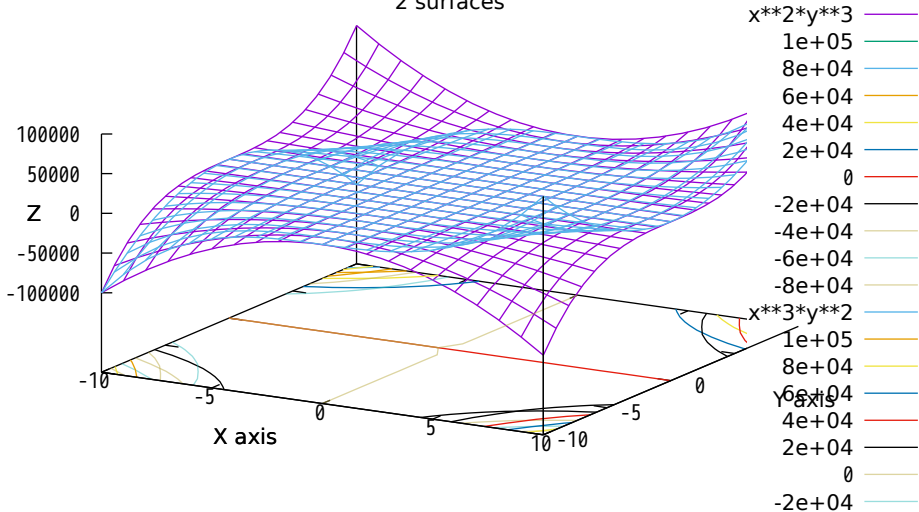

some more interesting contours

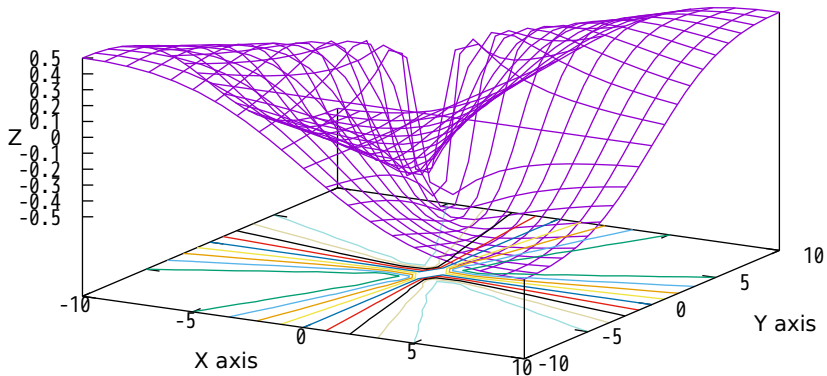

some more interesting contours

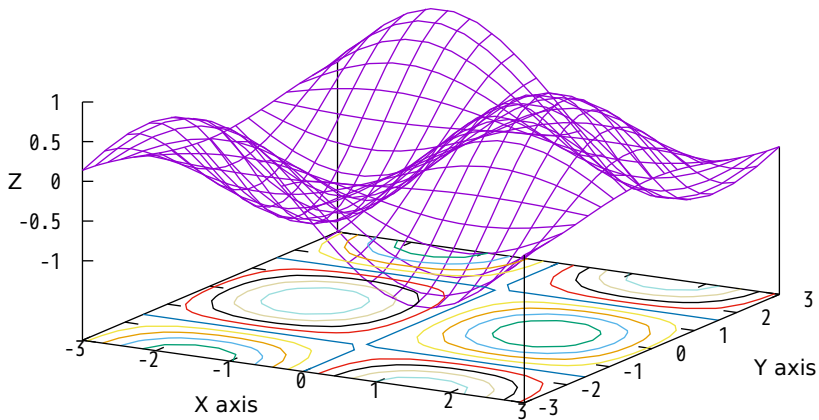

low resolution (6x6)

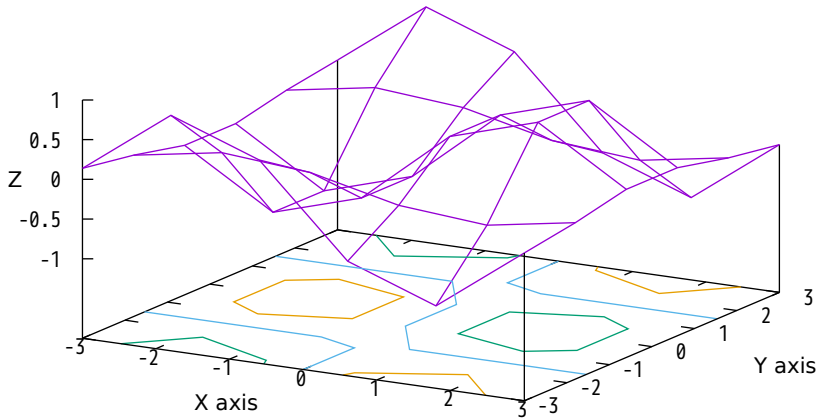



low resolution (6x6) using cubic splines

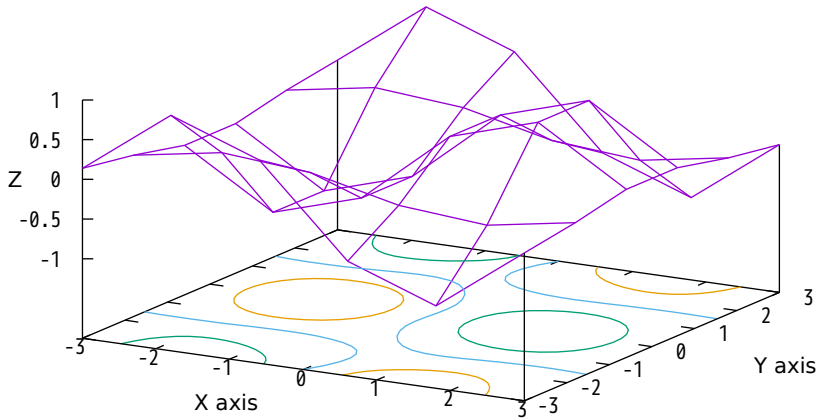

low resolution (6x6) using bspline approx.

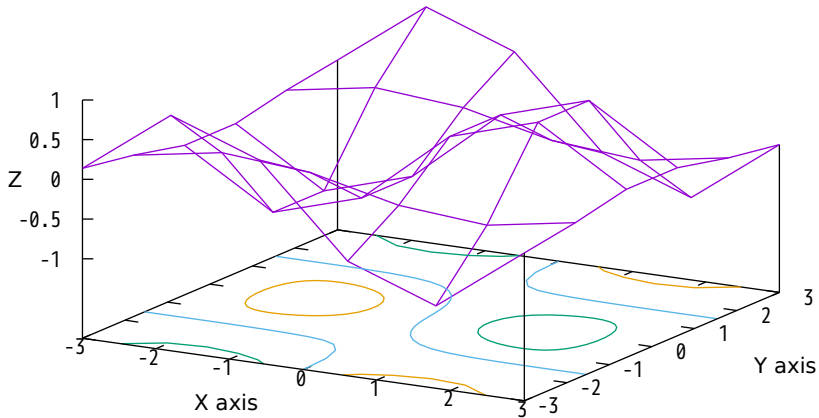

low resolution (6x6) raise bspline order.

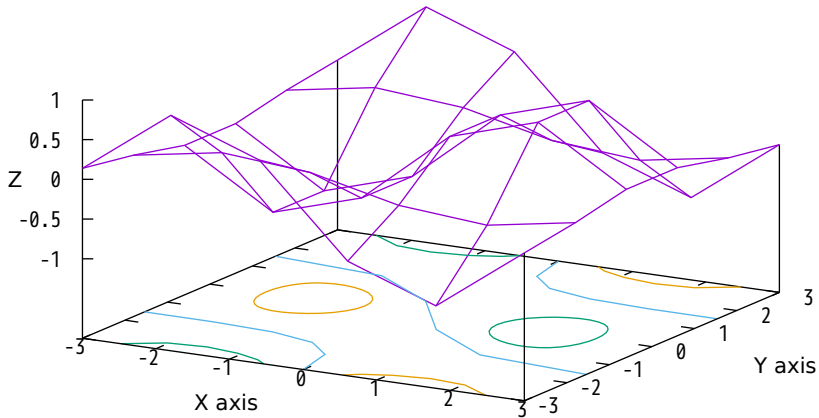

contour of Sinc function  
 $\sin(\sqrt{x^2+y^2}) / \sqrt{x^2+y^2}$

0.5  
0

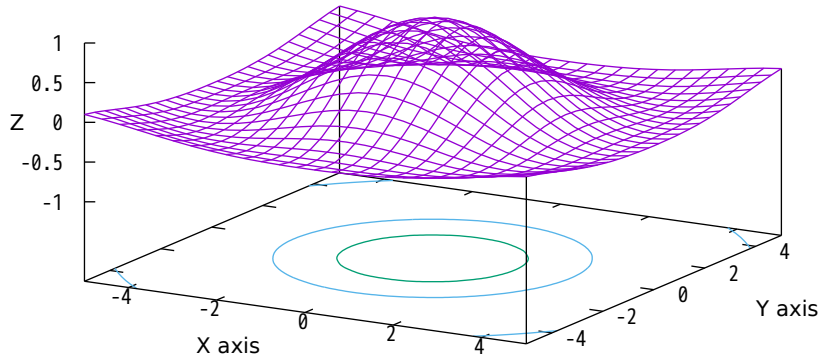

contour of Sinc function  
 $\sin(\sqrt{x^2+y^2}) / \sqrt{x^2+y^2}$

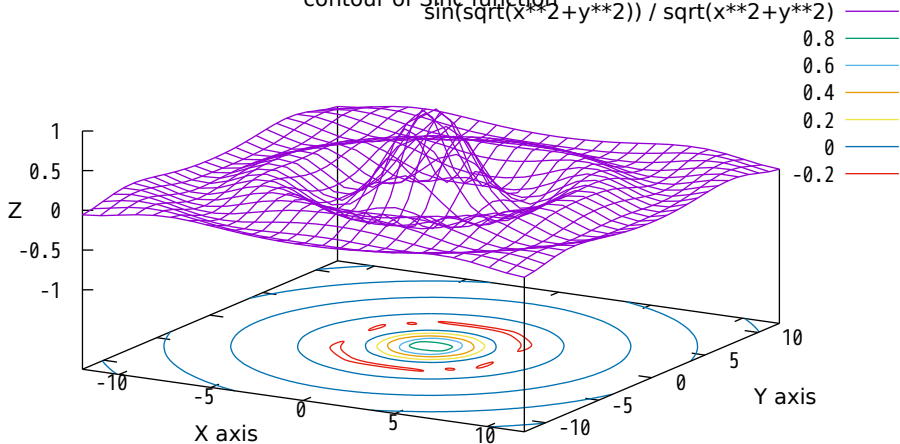

contour of data grid plotting

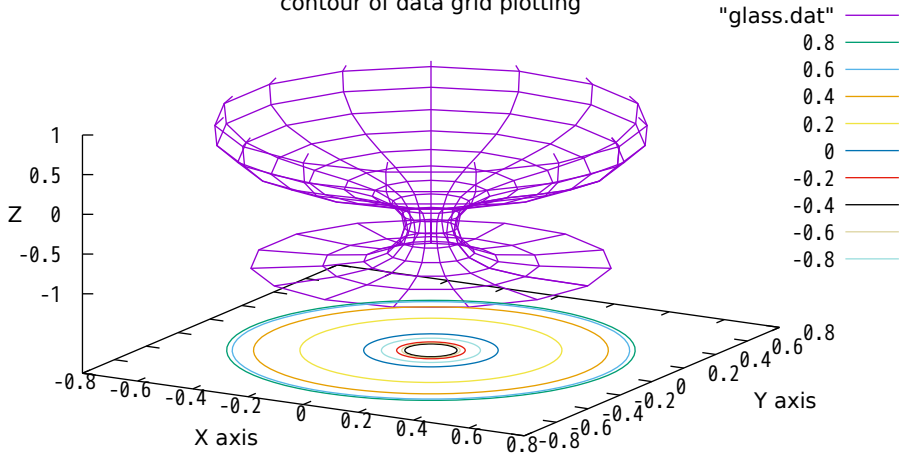

contour of data grid plotting

"glass.dat" using 1

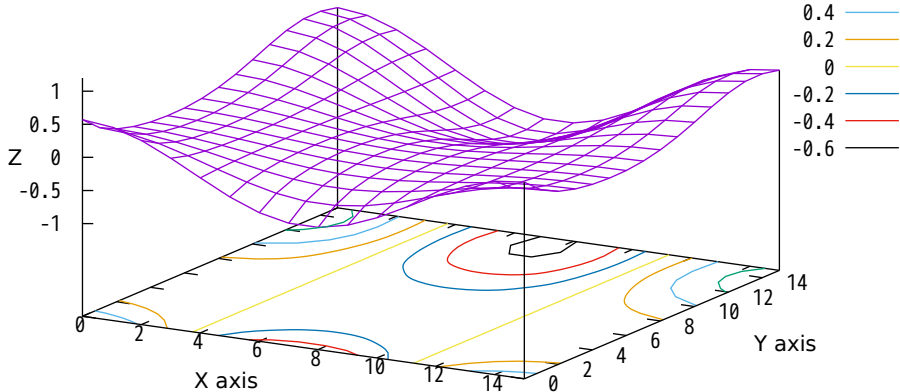

2D contour projection of previous plot

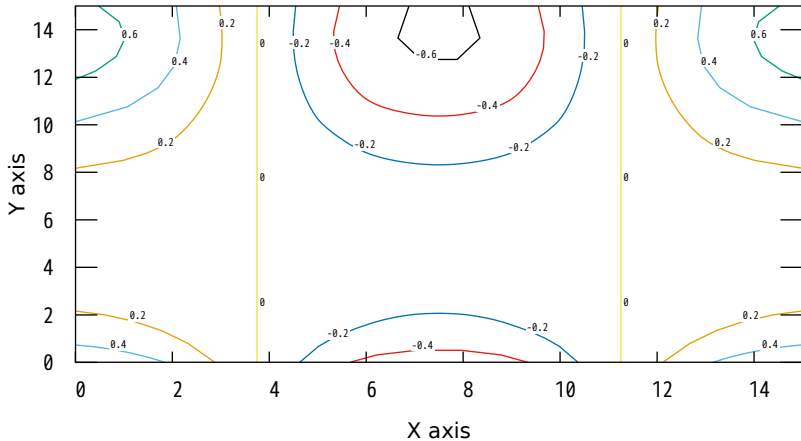



# Rosenbrock Function

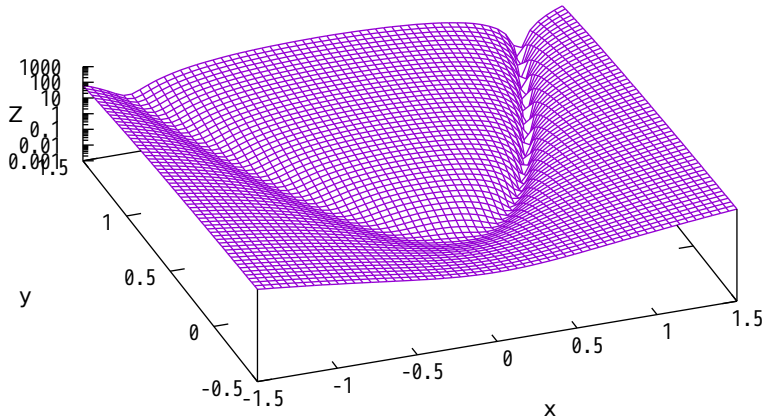

# Rosenbrock Function

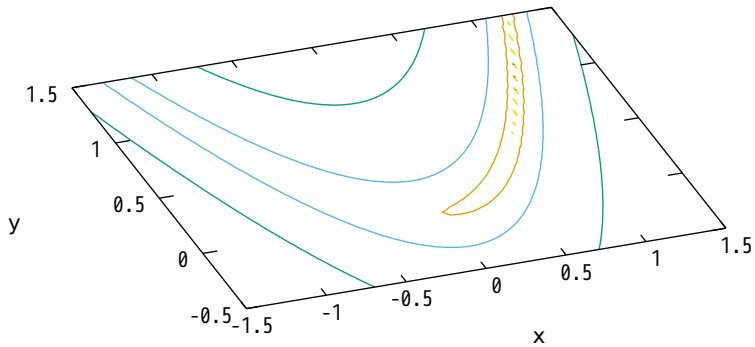

All contours drawn in a single color

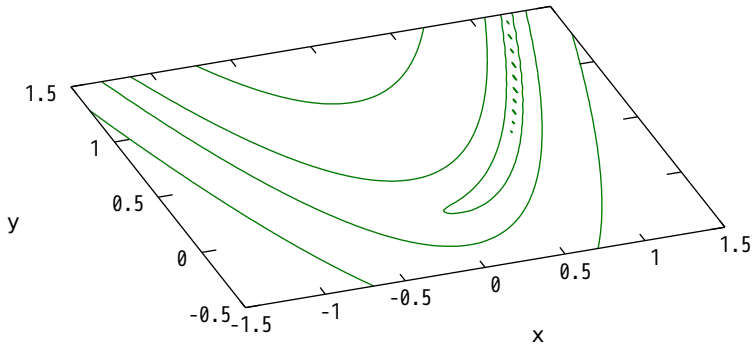

## Sometimes it helps to use multiplot

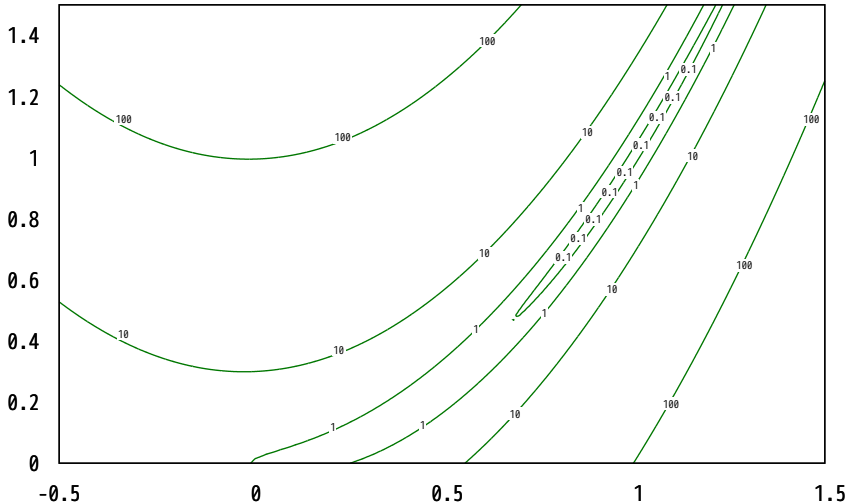

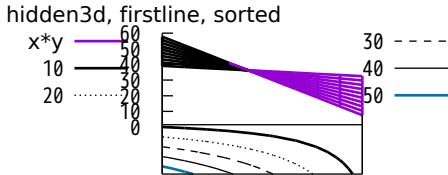
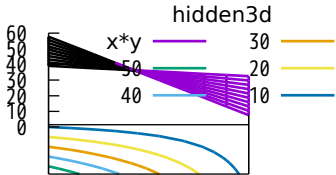
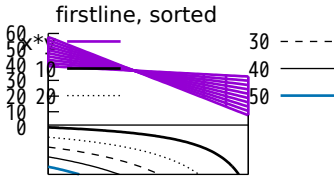
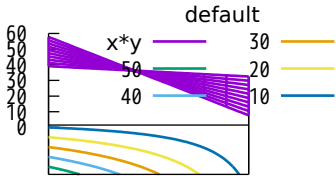

## Demo of multiple mesh per file capability - Digitized Blue Whale

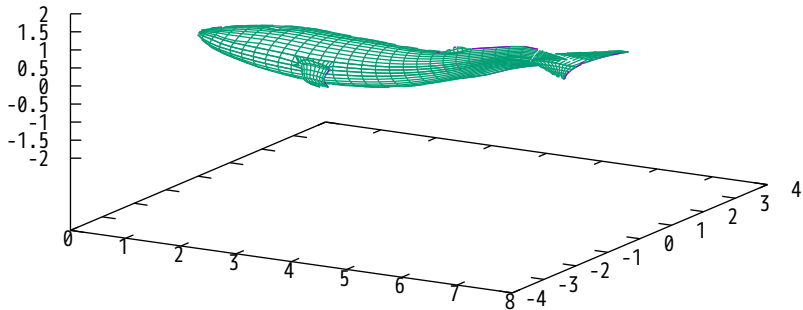

# Demo of multiple mesh per file capability - Digitized Blue Whale

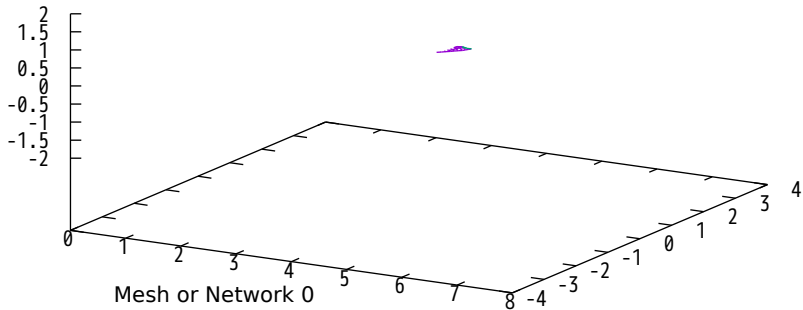

# Demo of multiple mesh per file capability - Digitized Blue Whale

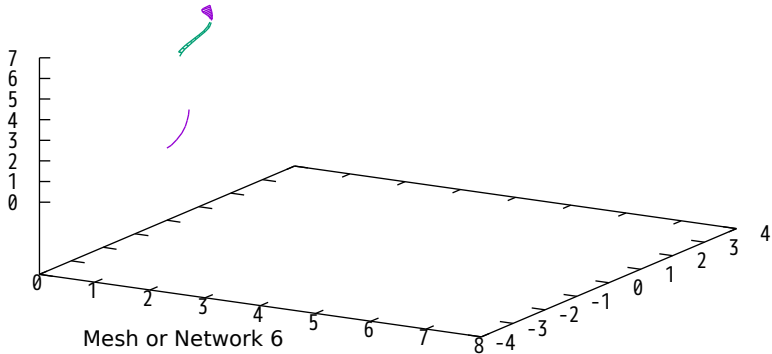



## Demo of multiple mesh per file capability - Digitized Blue Whale

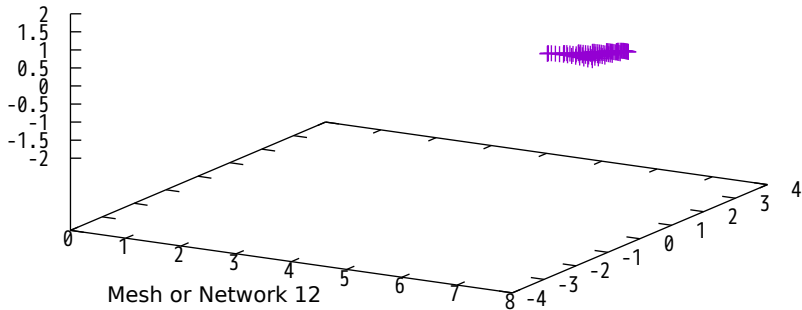

# Demo of multiple mesh per file capability - Digitized Blue Whale

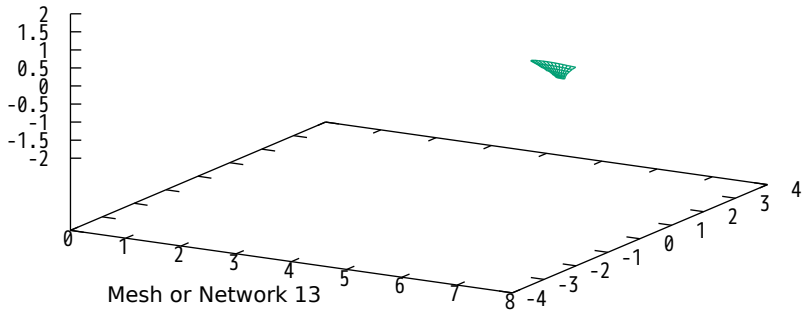

# Demo of multiple mesh per file capability - Digitized Blue Whale

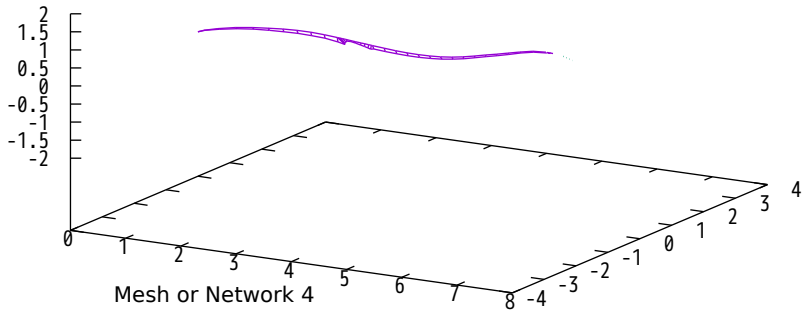

## Demo of multiple mesh per file capability - Digitized Blue Whale

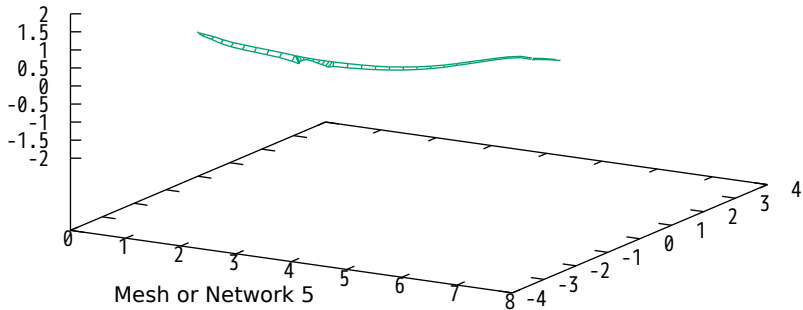

# approximate the integral of functions

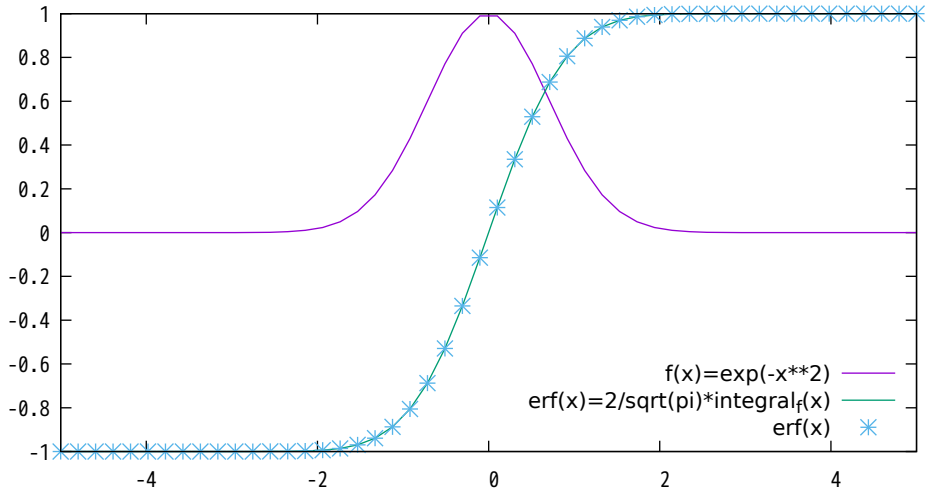

# approximate the integral of functions

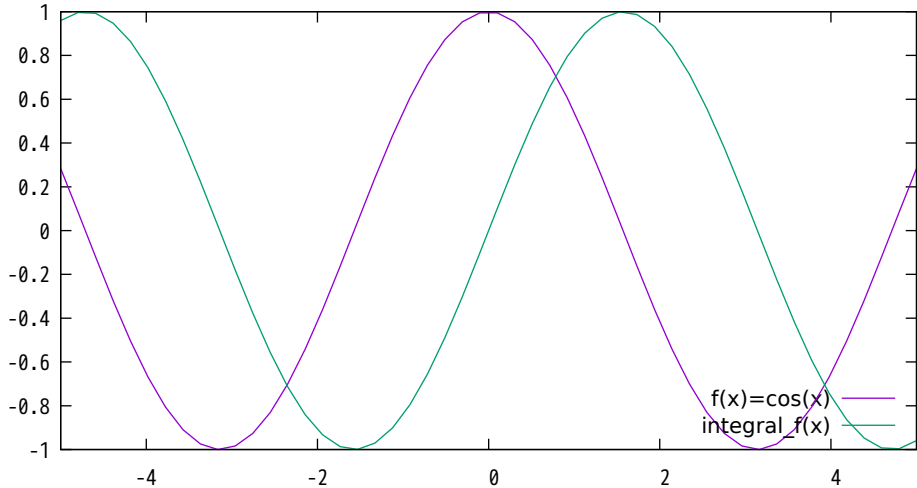

approximate the integral of functions (upper and lower limits)

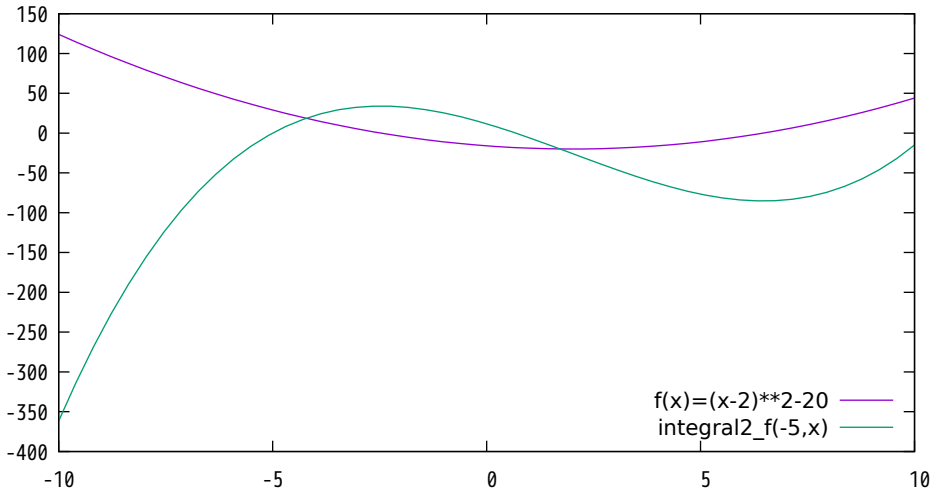

approximate the integral of functions (upper and lower limits)

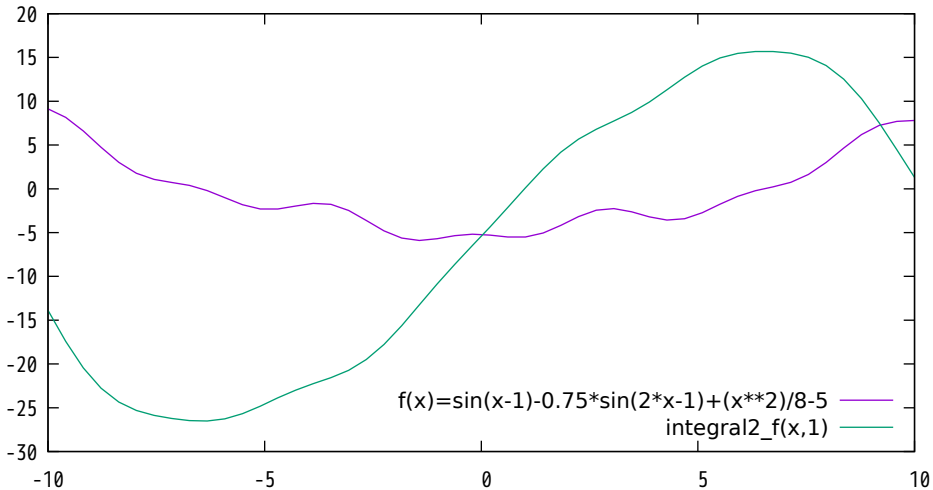



Plot of the ackermann function

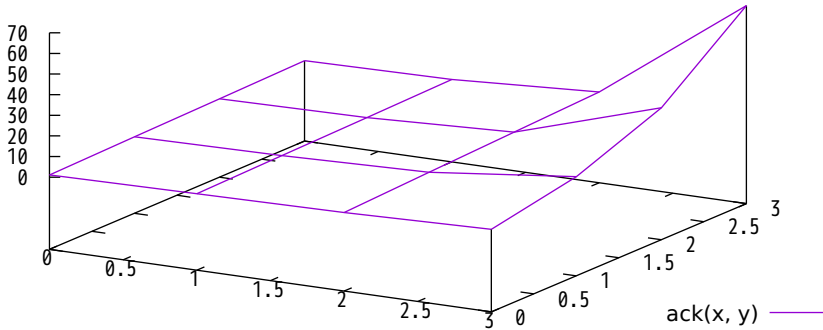

Min(x,y) and Max(x,y)

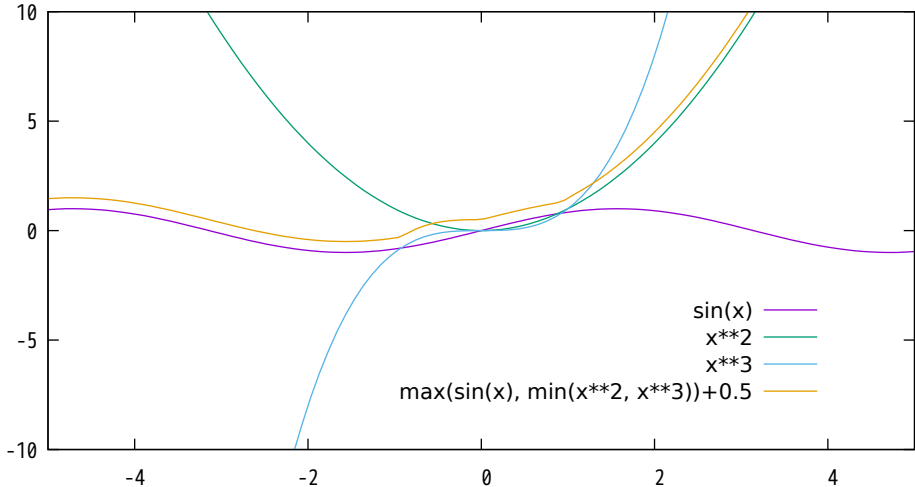

# Greatest Common Divisor (for integers only)

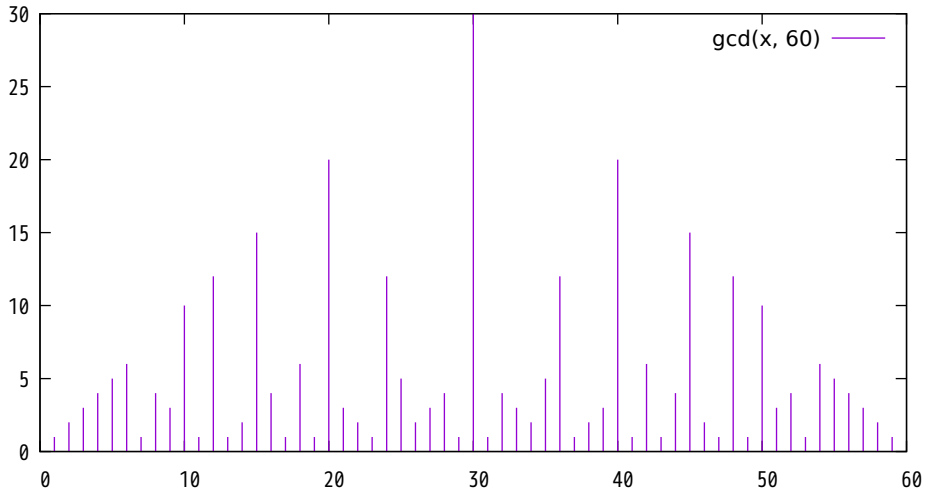

Finite summation of 10, 100, 1000 fourier coefficients

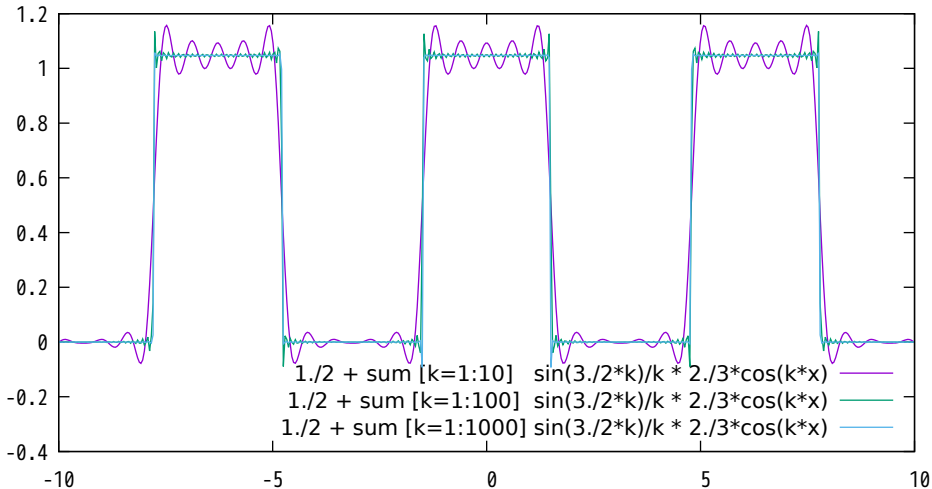

Fsteps plot  
with date and time as x-values

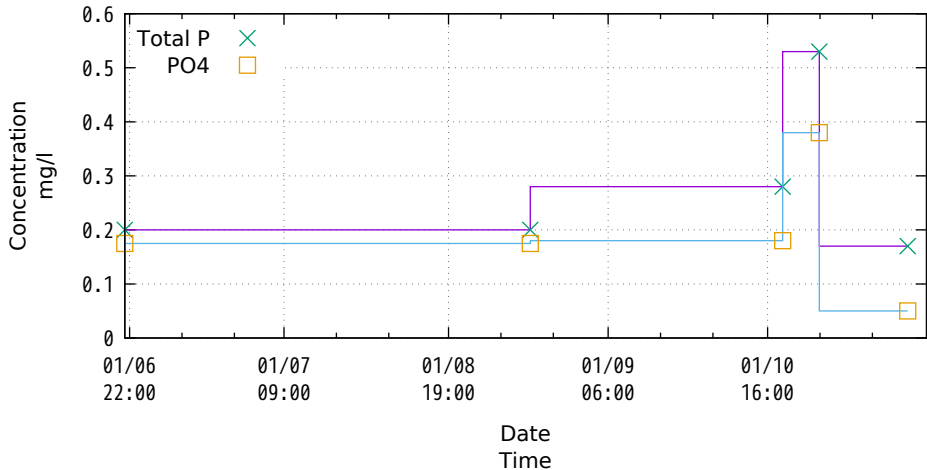

# Time data on Y, millisecond precision

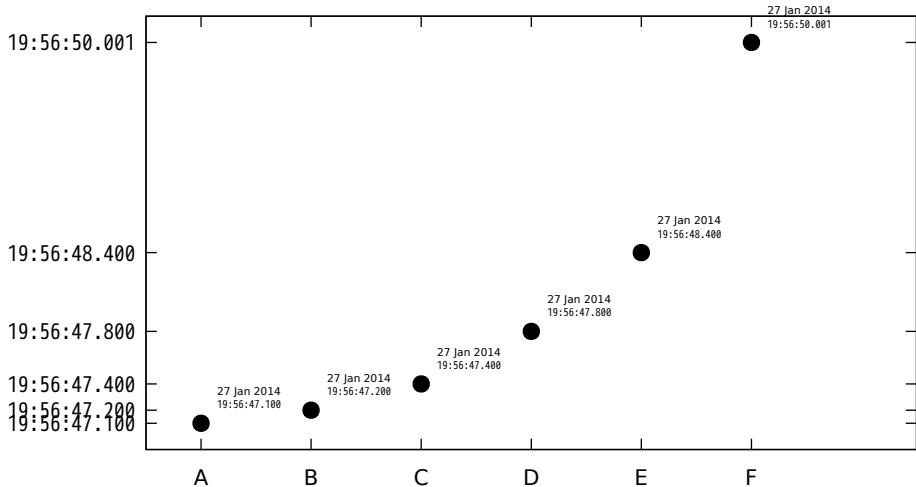

## Date format (top) vs Time format (bottom)

12/31/69	12/31/69	12/31/69	12/31/69	12/31/69	12/31/69	12/31/69	01/01/70	01/01/70	01/01/70	01/01/70
22:15	22:30	22:45	23:00	23:15	23:30	23:45	00:00	00:15	00:30	00:45

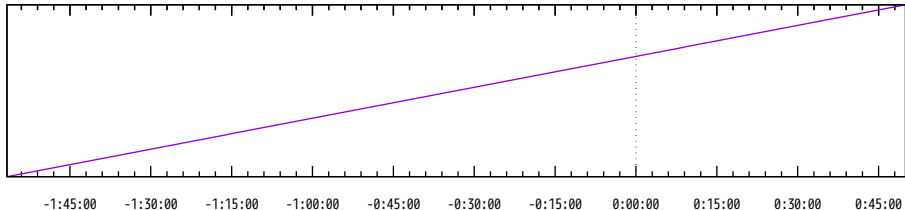

# Simple Gantt Chart

Task start and end times in columns 2 and 3

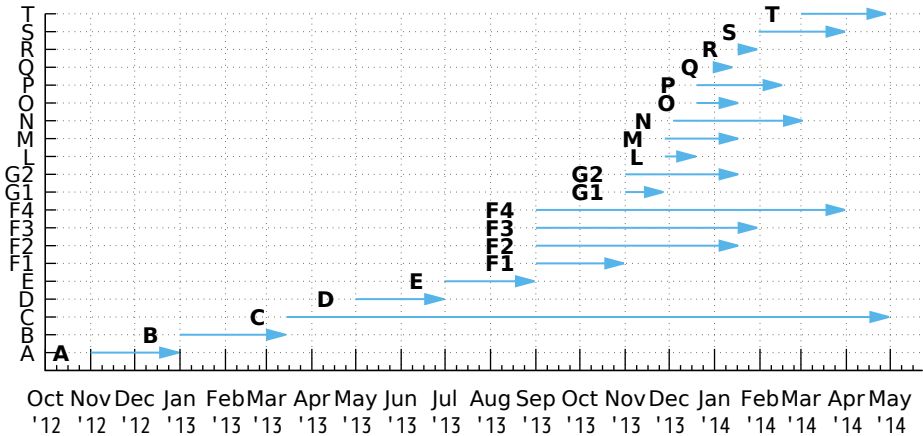



# Simple Gantt Chart

Task start and end times in columns 2 and 3

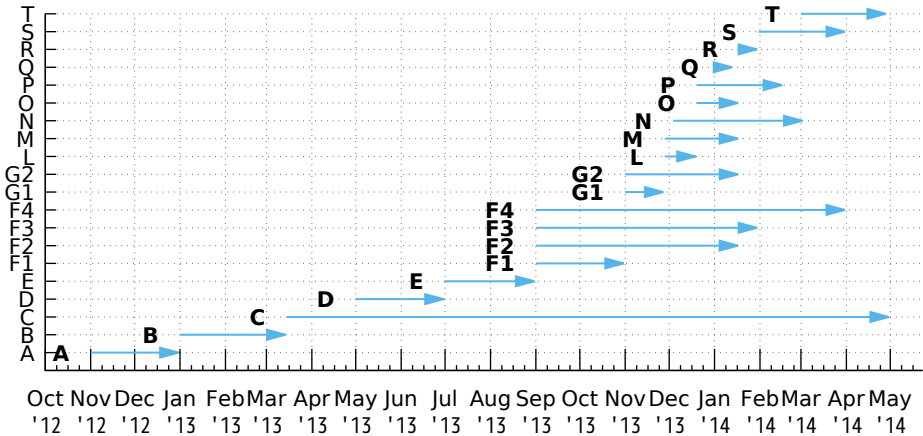

## Terminal-independent RGB colors in 2D

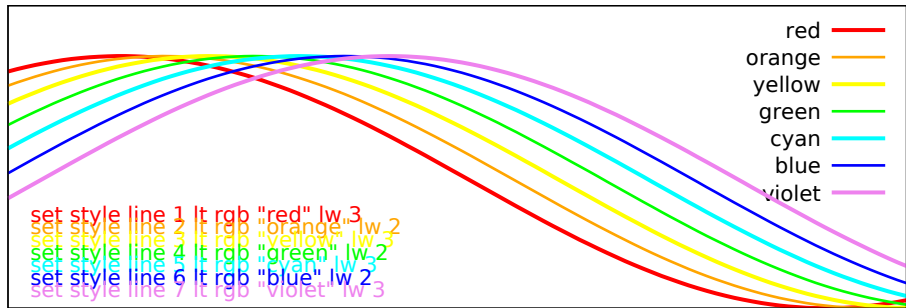

Implemented using built-in rgb color names  
(only works for terminals that can do full rgb color)

Terminal-independent palette colors in 2D  
Implemented using command line macros referring to a fixed HSV palette

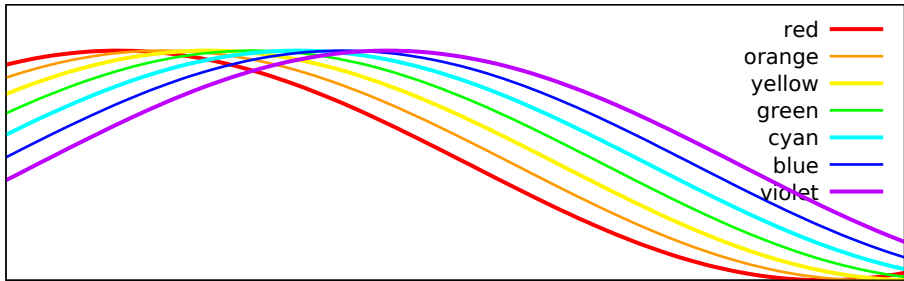

HSV color wheel

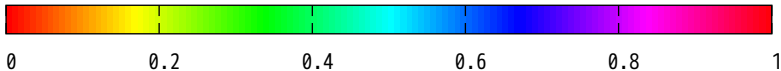

RGB color information read from data file

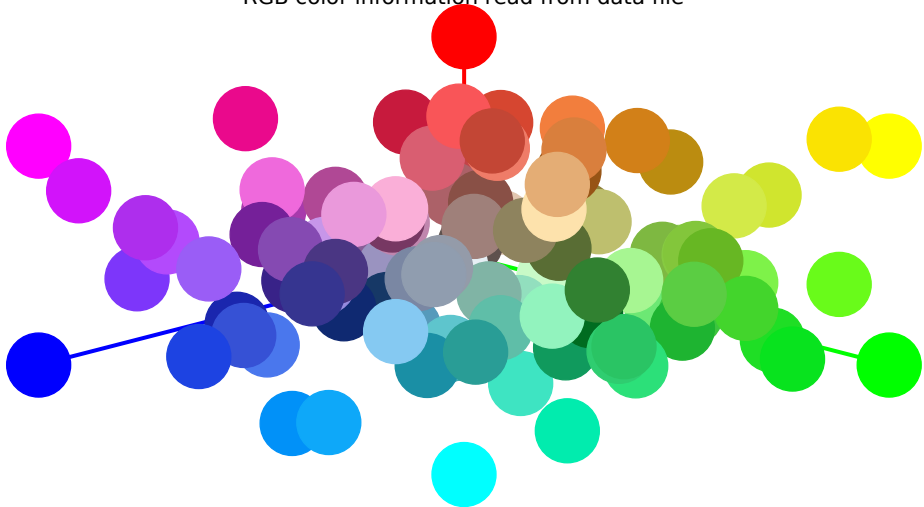

Both RGB color information  
and point size controlled by input

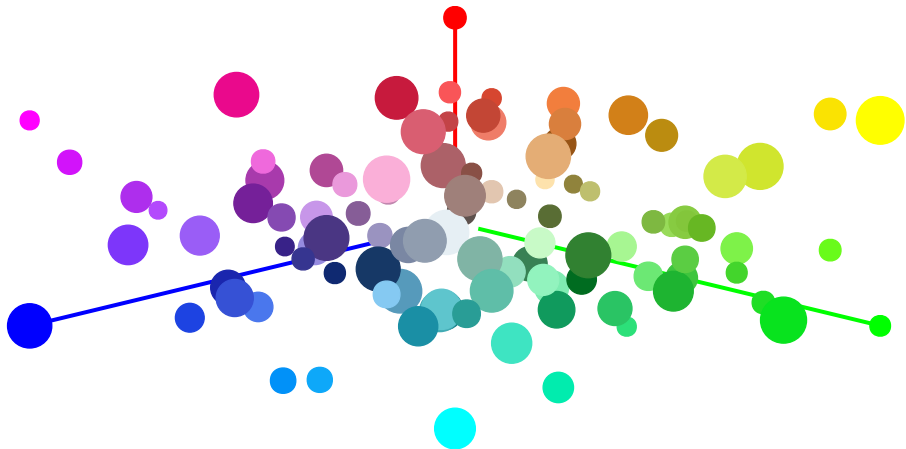

Both RGB color information  
and file size controlled by input.

0x1fabe.dat using 1:2:3:(rgb(\$1,\$2,\$3

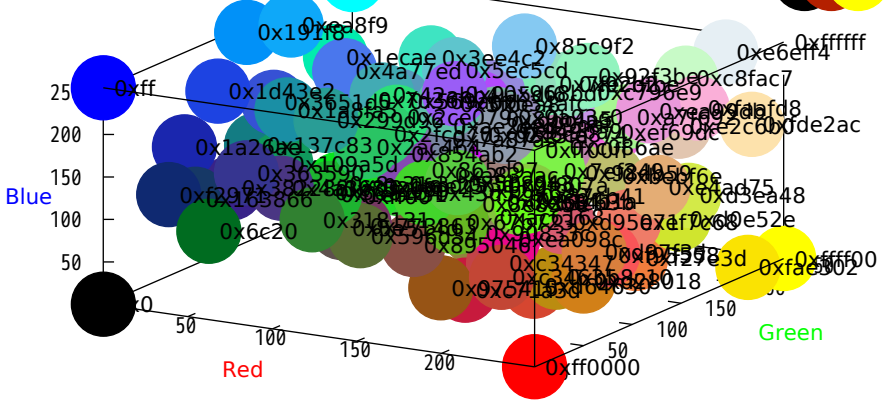

Both RGB color information  
and point size controlled by input  
variable (point size and rgb color read as hexadecimal)

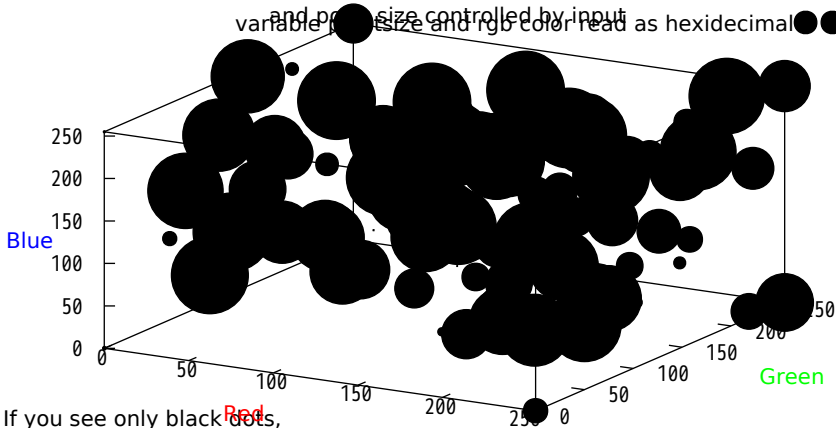

If you see only black dots,  
this means your platform does not  
support reading hexadecimal constants  
from a data file. Get a newer libc.

Both RGB color information  
and point size controlled by input  
variable position and rgb color computed from coord

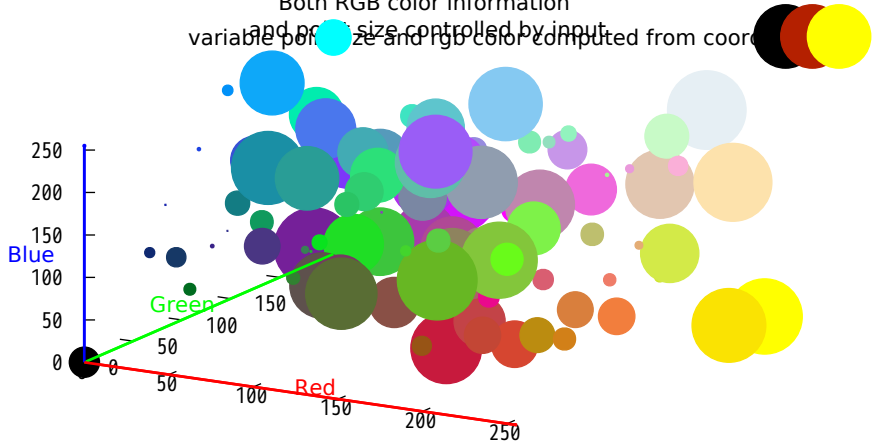



Demo of hidden3d with points only (no surface)

variable pointsize and rgb color computed from coords ● ● ●

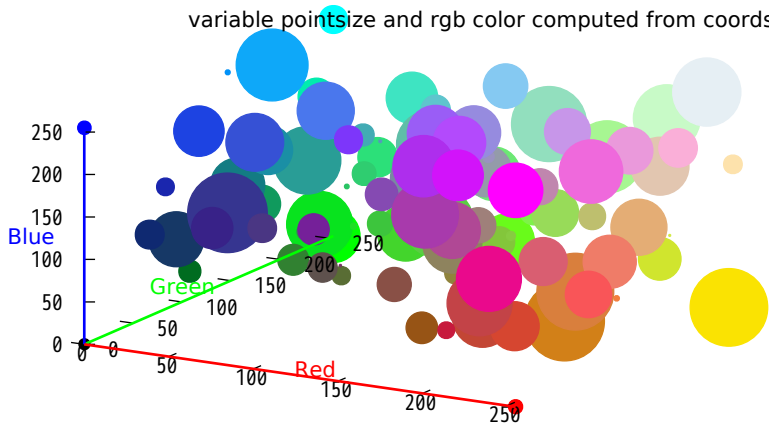

# RGB coloring of pm3d surface

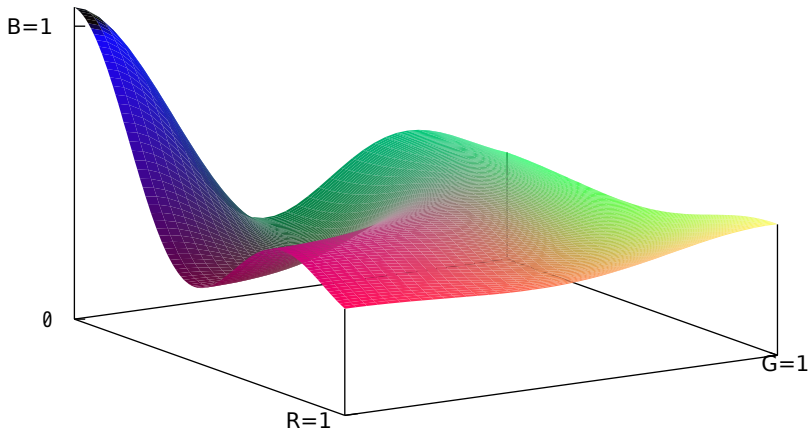

HSV coloring of pm3d surface  
(V=1)

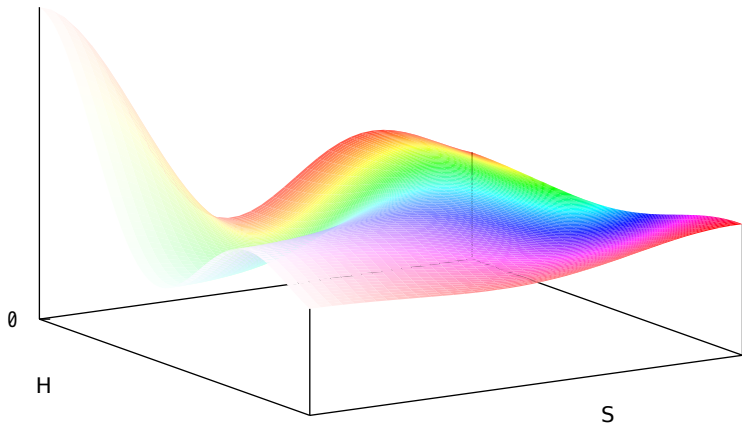

# Explicit borders for pm3d tiling

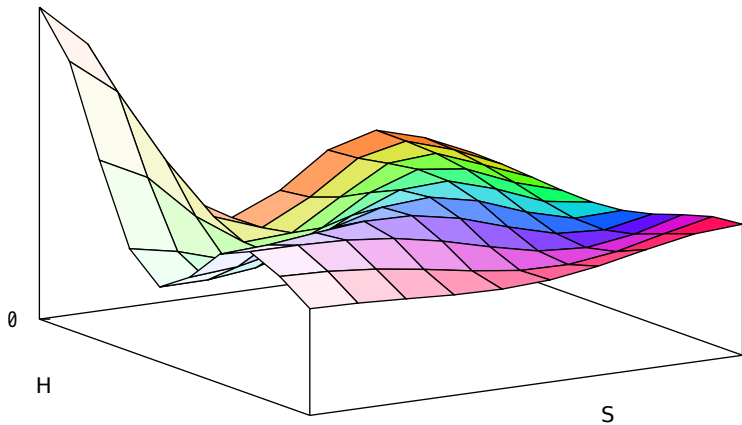

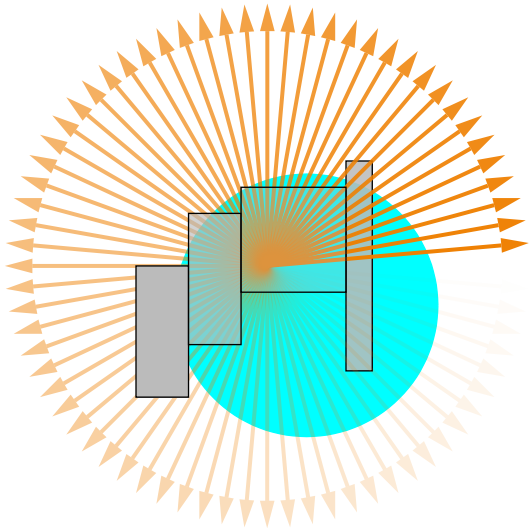

variable color points, circles, candlesticks, boxes, and boxxyerror

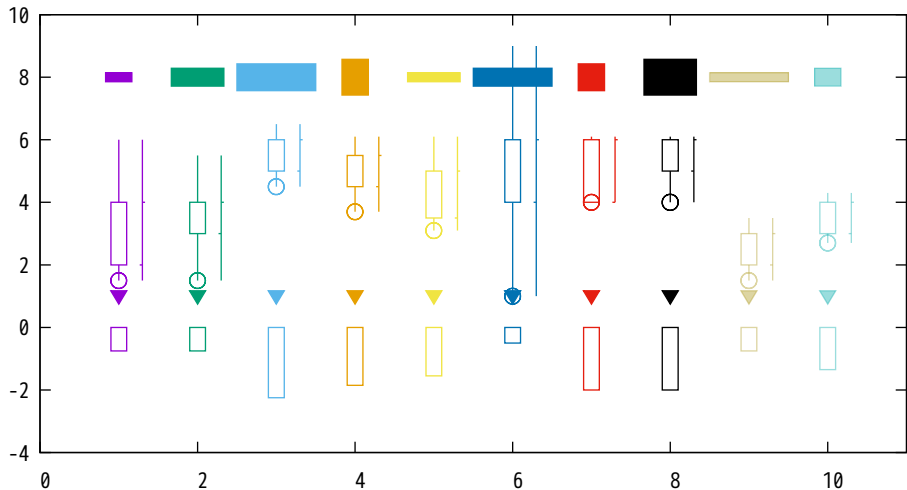

variable color boxerror, xyerrorbars, impulses, vectors, and labels

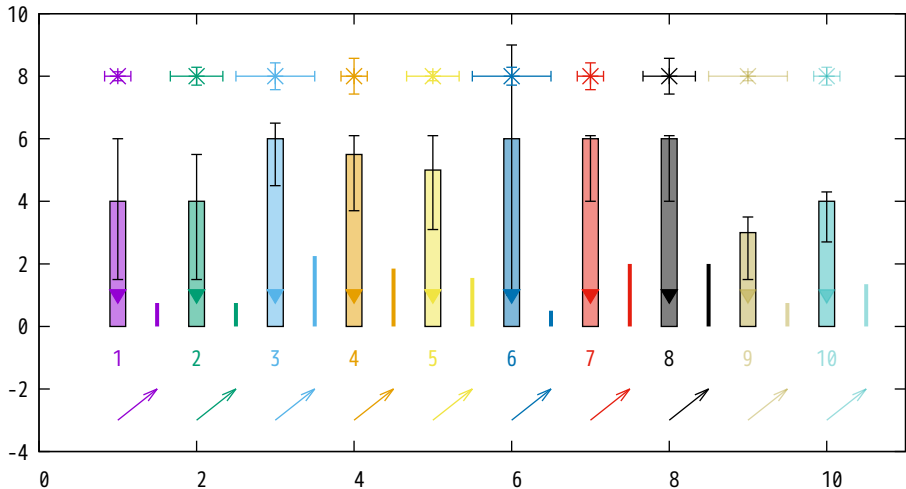

variable color using 'lc palette z'

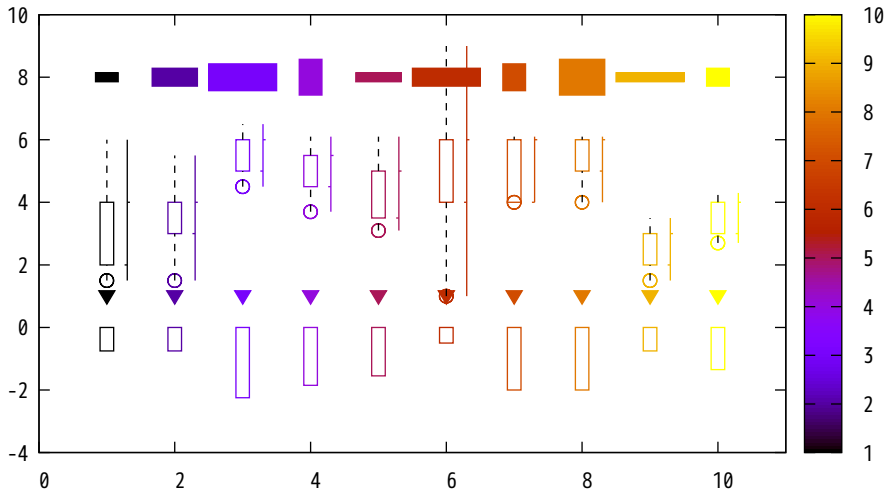



variable color using 'lc palette z'

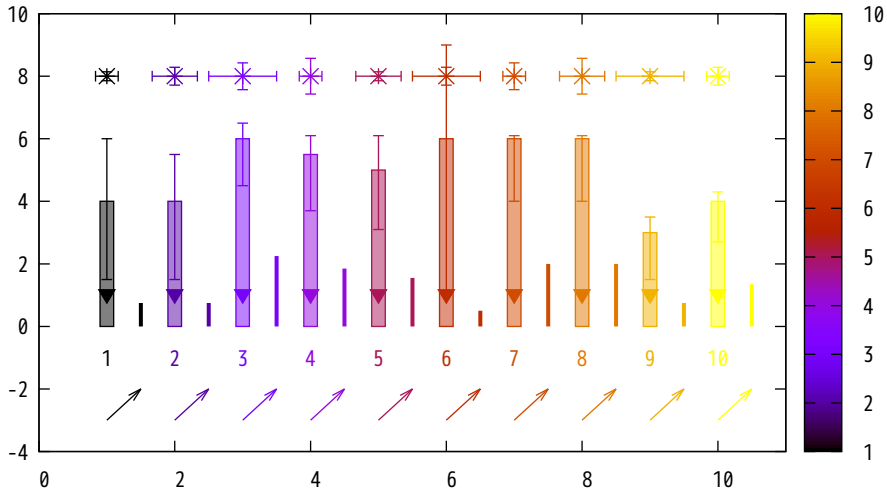

variable color using 'lc rgb variable'

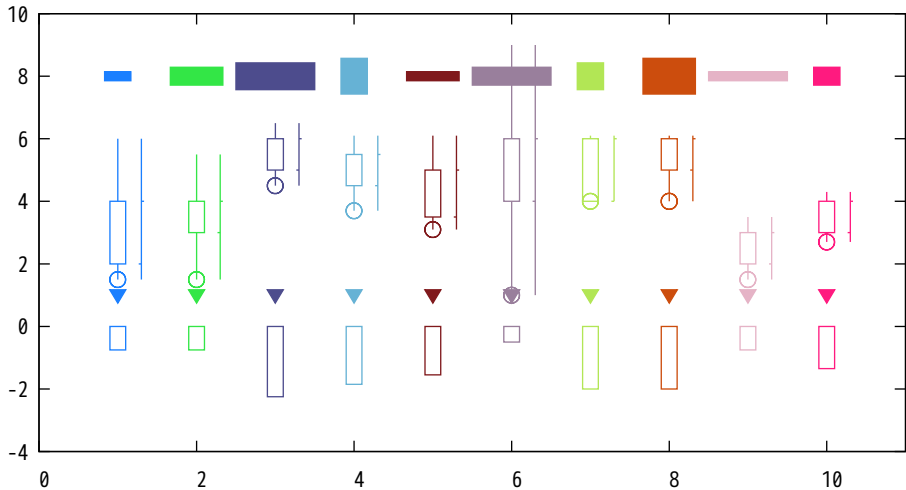

variable color using 'lc rgb variable'

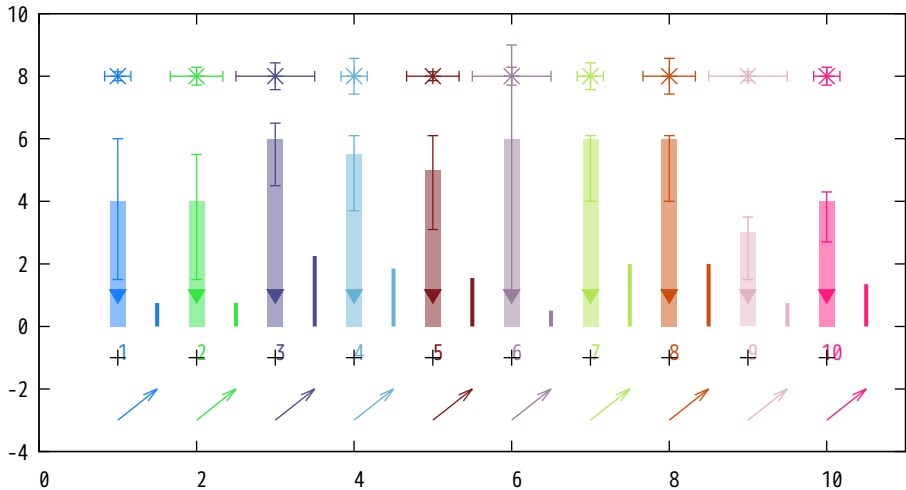

pm3d demo. Radial sinc function. Default options.

$$\frac{\sin(\sqrt{x^2+y^2})}{\sqrt{x^2+y^2}}$$

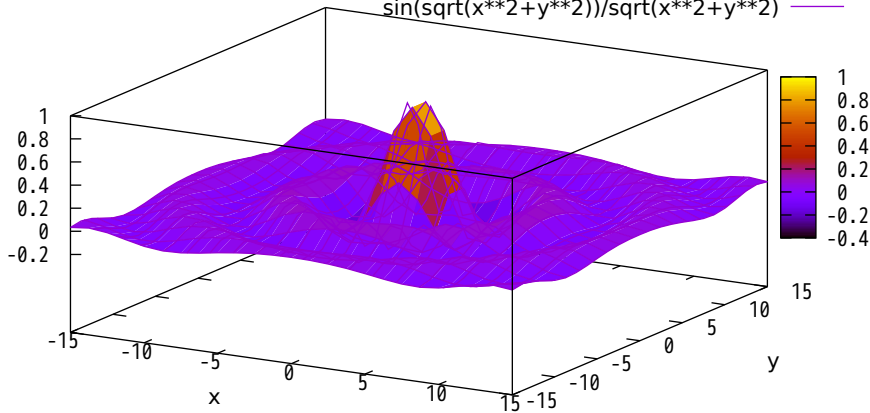

pm3d at s (surface) / ticslevel 0

$\sin(\sqrt{x^2+y^2})/\sqrt{x^2+y^2}$  —

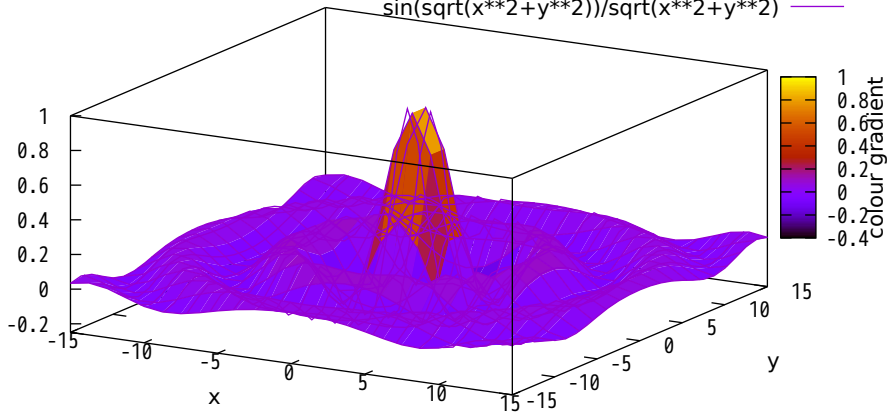

pm3d at b (bottom)

$\sin(\sqrt{x^2+y^2})/\sqrt{x^2+y^2}$  —

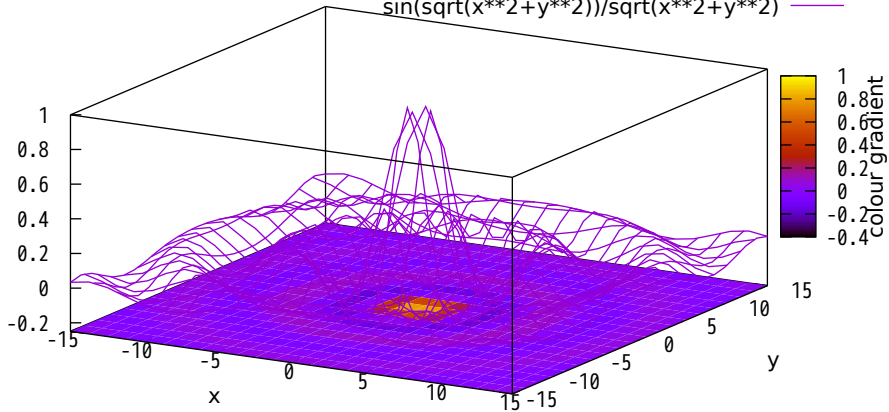

unset surface; set pm3d at st (surface and top)

$$\sin(\sqrt{x^2+y^2})/\sqrt{x^2+y^2}$$

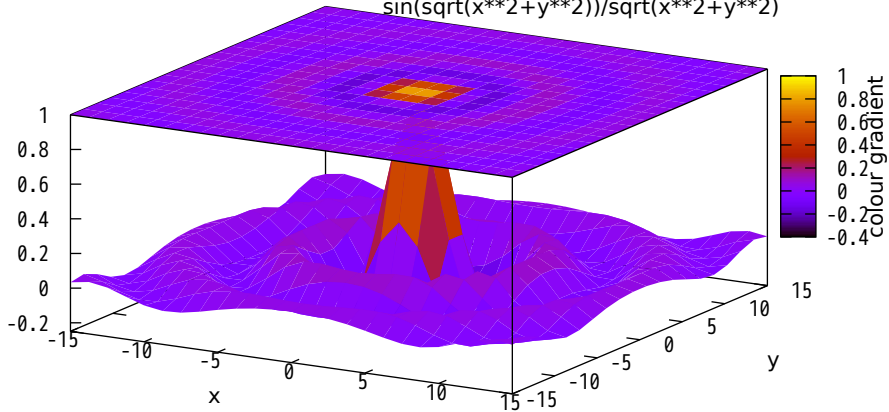

set pm3d at bstbst (funny combination, only for screen or postscript)

$$\sin(\sqrt{x^2+y^2})/\sqrt{x^2+y^2}$$

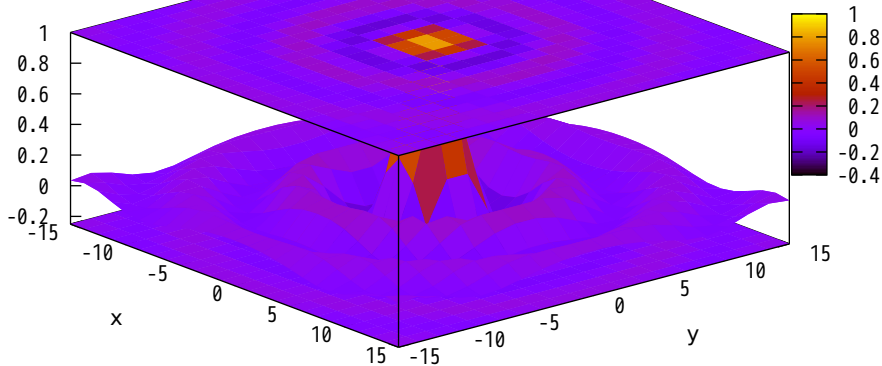



gray map

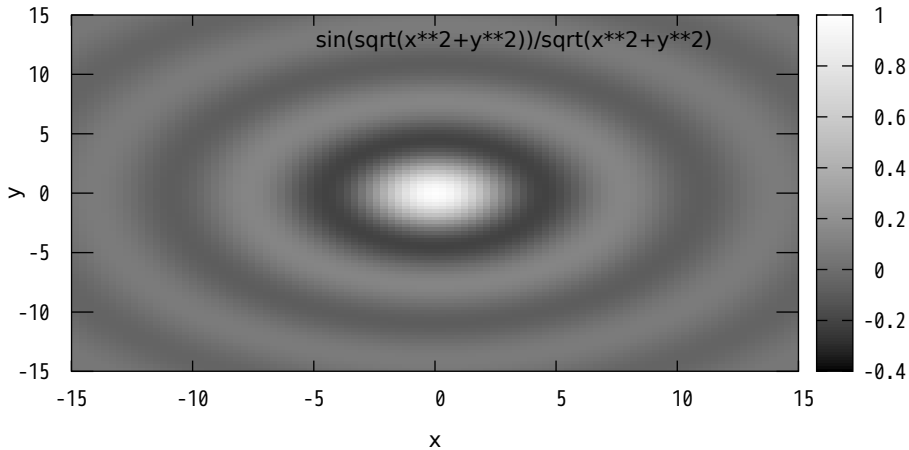

gray map, negative

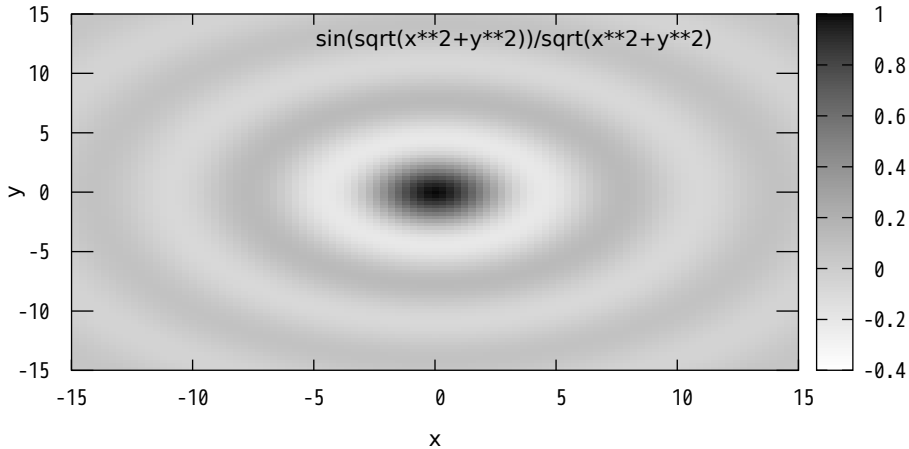

colour map, using default rgbformulae 7,5,15 ... traditional pm3d (black-blue-red-yellow)

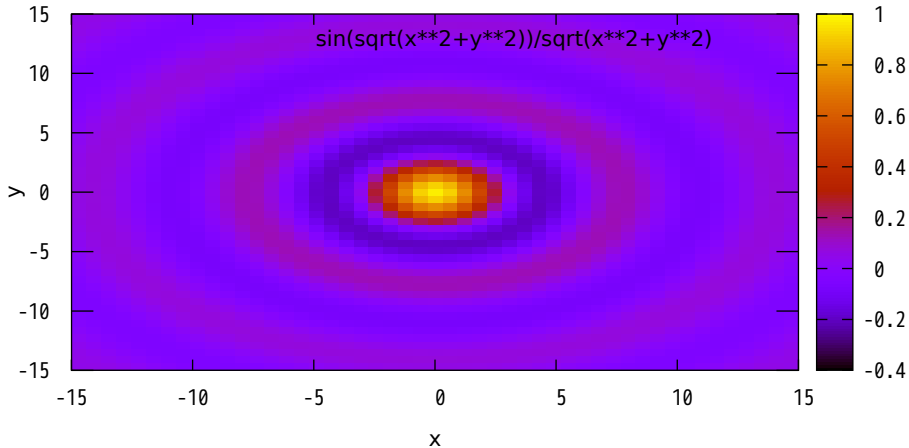

colour, rgbformulae 3,11,6 ... green-red-violet

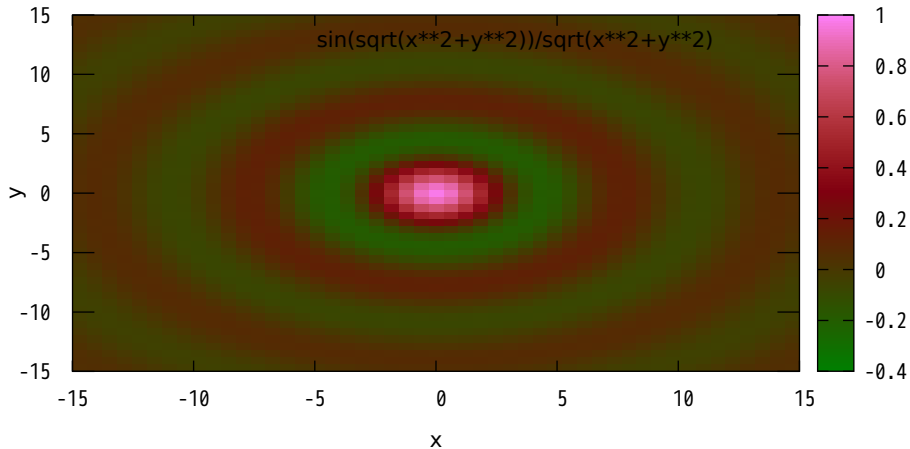

colour, rgbformulae 23,28,3 ... ocean (green-blue-white); OK are also all other permutation

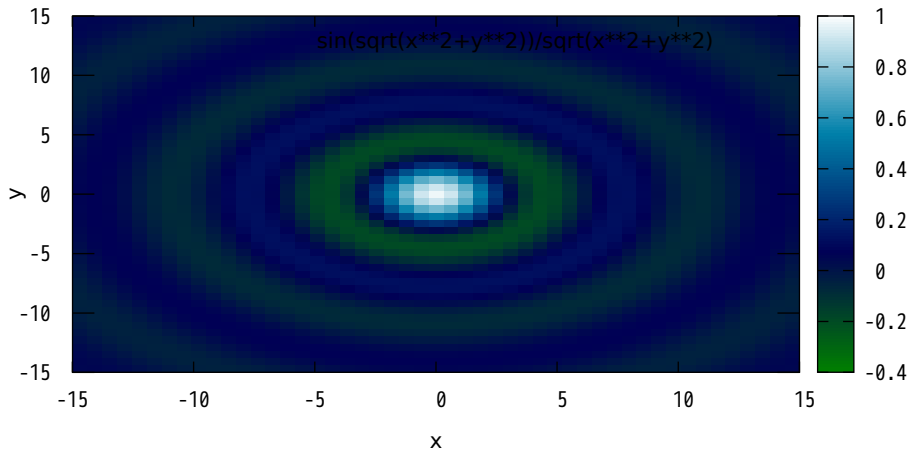

colour, rgbformulae 30,31,32 ... color printable on gray (black-blue-violet-yellow-white)

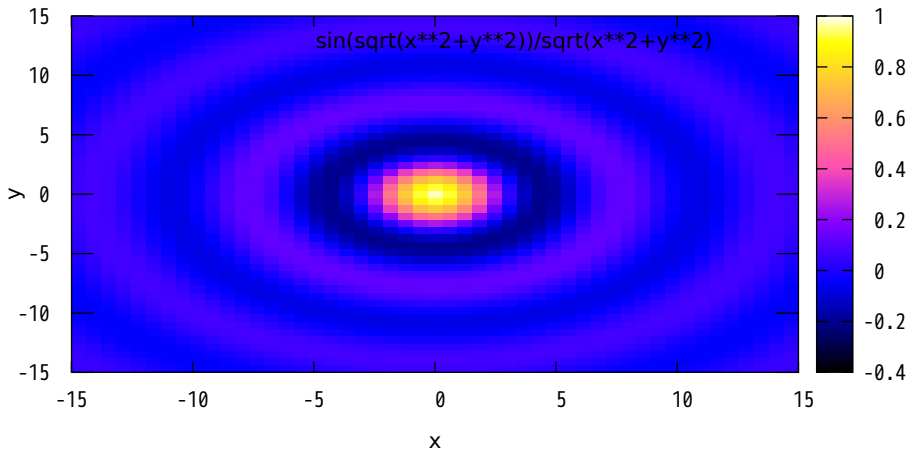

cubehelix color scheme with monotonic intensity  
D A Green (2011) <http://arxiv.org/abs/1108.5083>

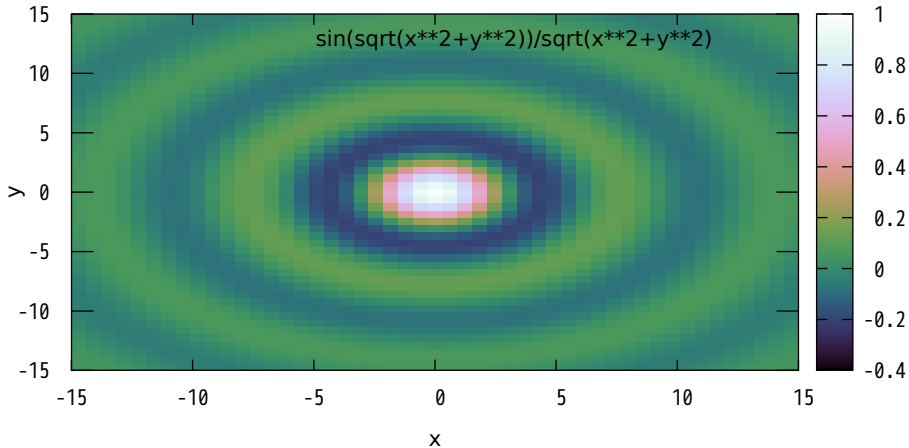

R,G,B profiles of the current color palette  
red — green — blue — NTSC —

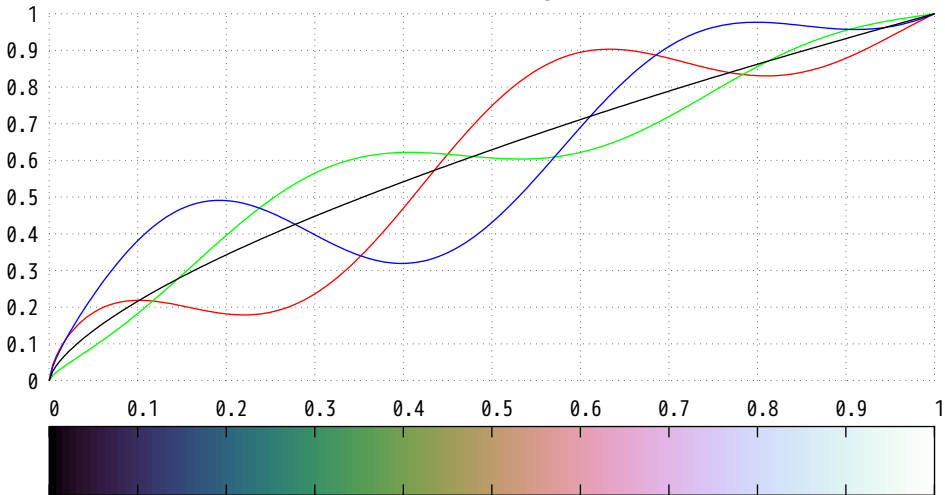



rgbformulae 31,-11,32: negative formula number=inverted color

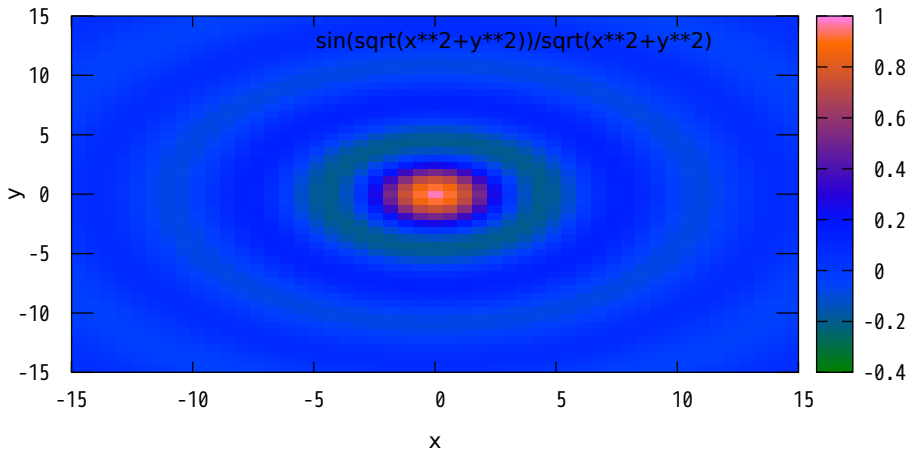

set pm3d scansforward: wrong, because back overwrites front

$$\sin(\sqrt{x^2+y^2})/\sqrt{x^2+y^2}$$

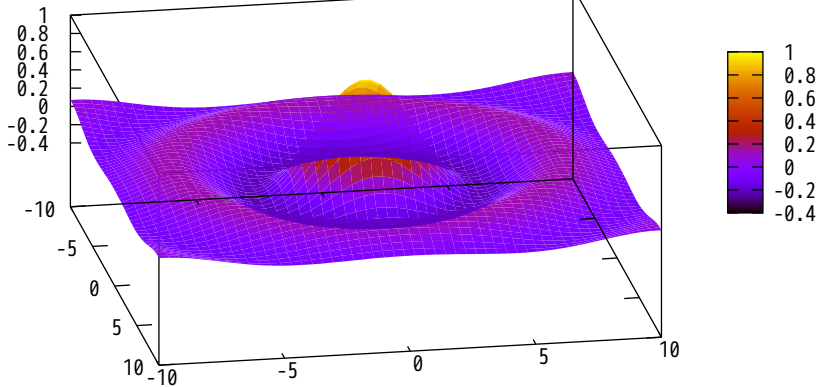

set pm3d scansbackward: correctly looking surface

$$\sin(\sqrt{x^2+y^2})/\sqrt{x^2+y^2}$$

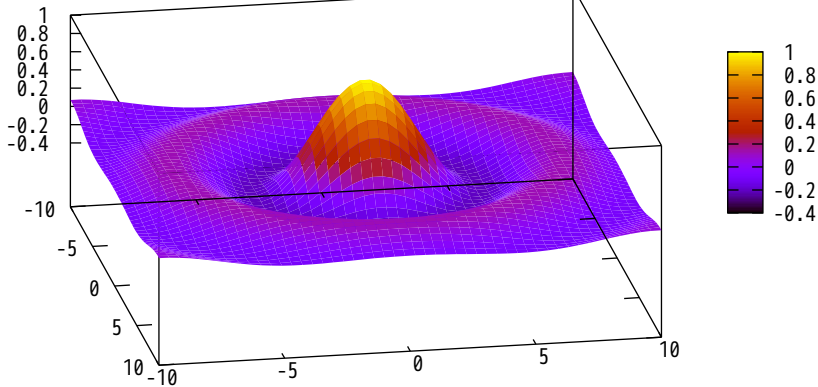

set hidden3d

$\log(x*x*y*y)$  —

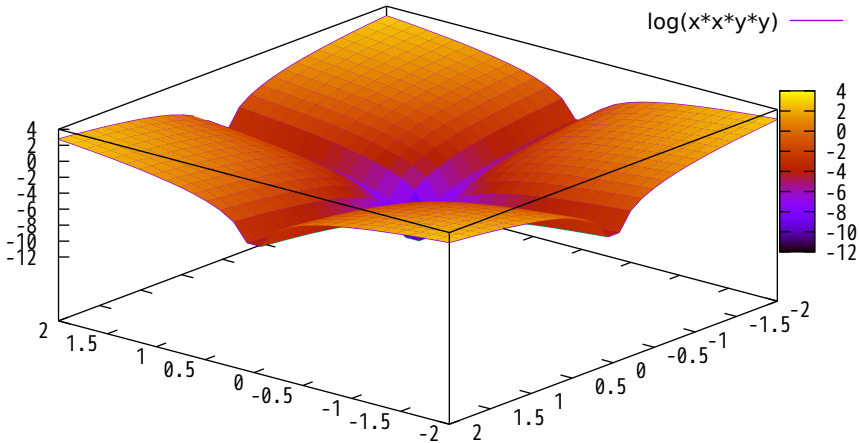

set pm3d hidden3d <linetype>: pm3d's much faster hidden3d variant

$\log(x*x*y*y)$

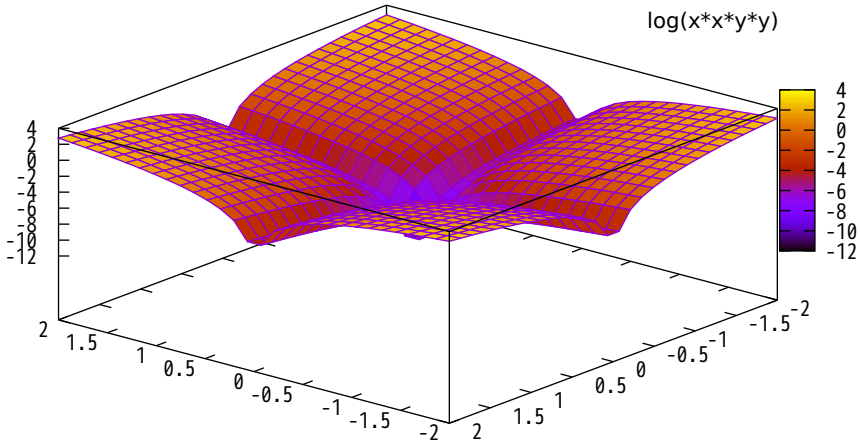

bad: surface and top are too close together

$\log(x*x*y*y)$

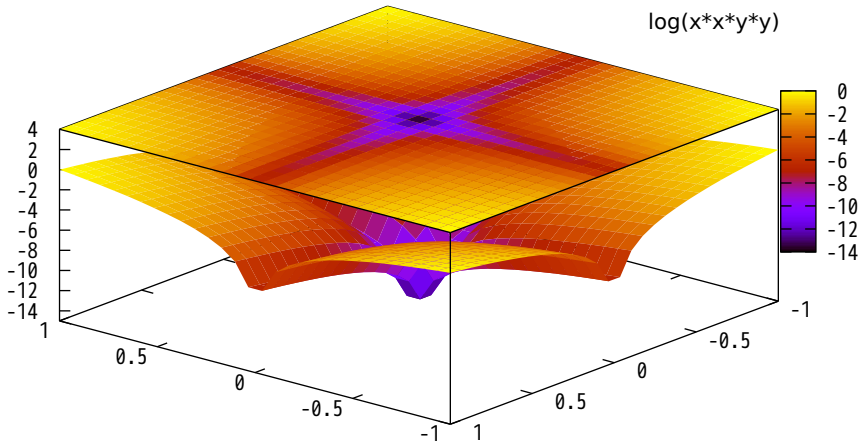

solution: use independent 'set zrange' and 'set cbrange'

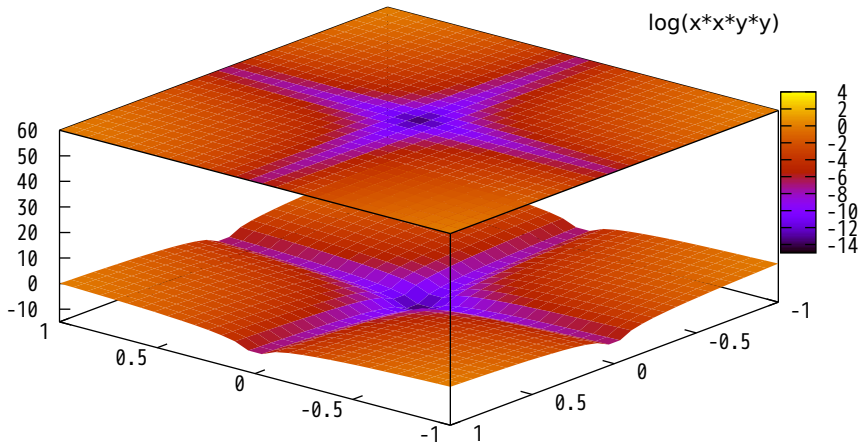

color box is on by default at a certain position

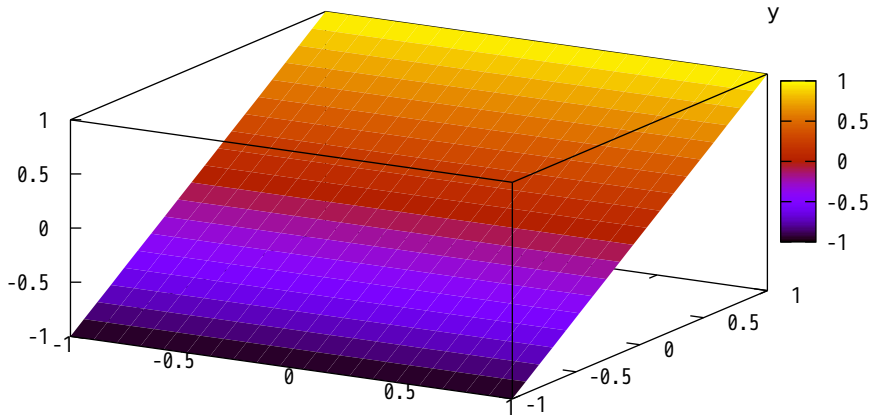



color box is on again, now with horizontal gradient

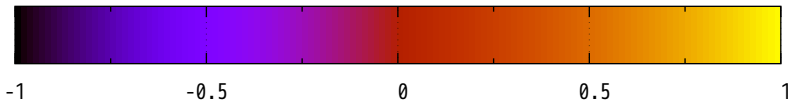
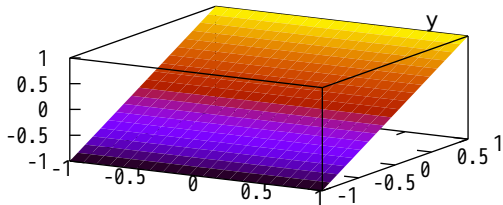

see xlabel, grid cb, mcxticks, ...

color box is switched off

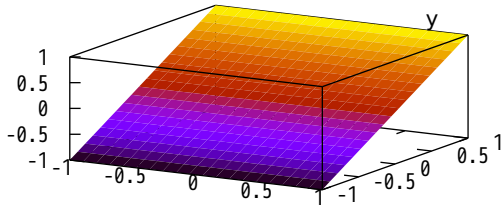

using now "set grid back; unset colorbox"

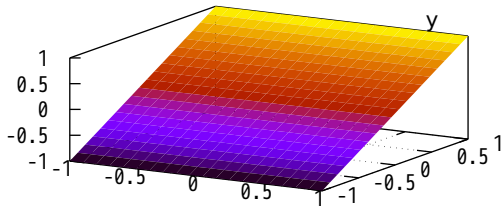

Datafile with different nb of points in scans; pm3d flush begin

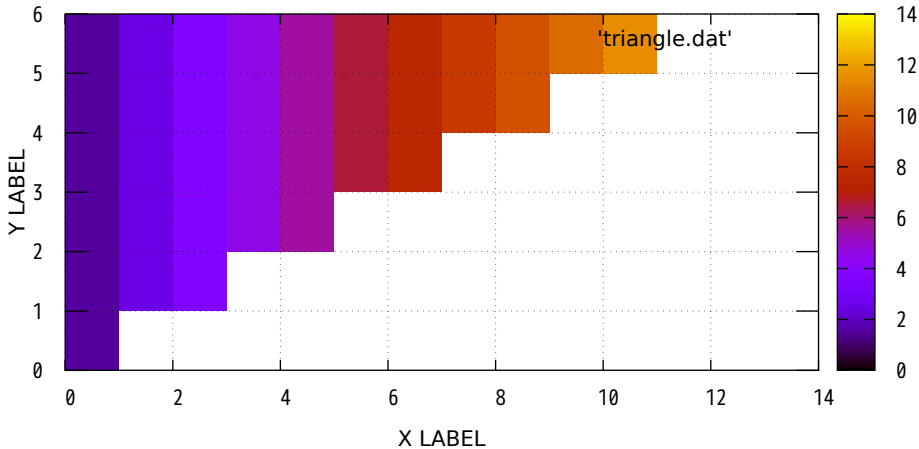

Datafile with different nb of points in scans; pm3d flush center

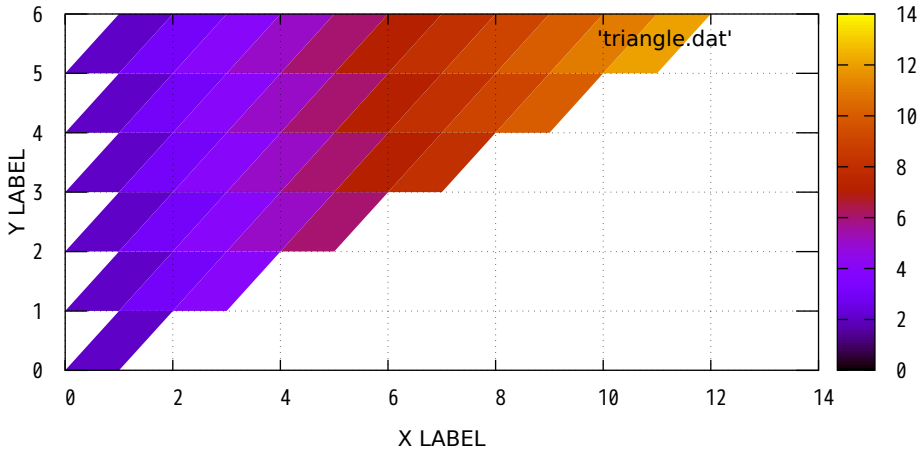

Datafile with different nb of points in scans; pm3d flush end

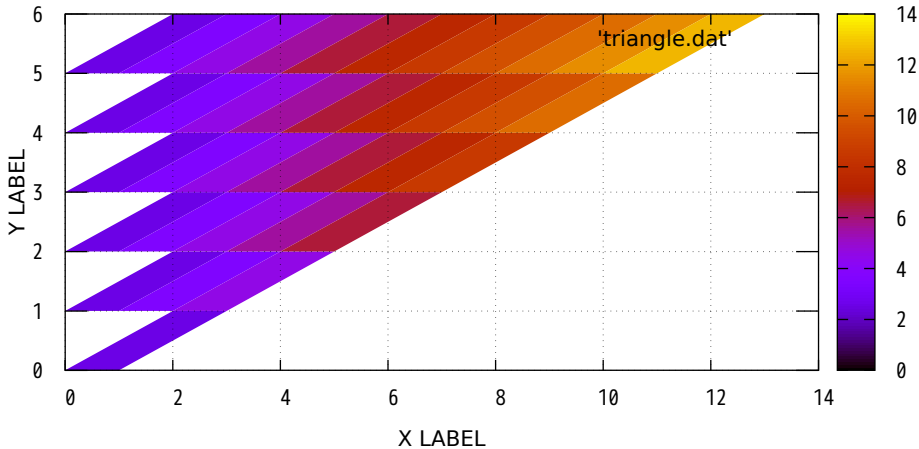

Data with different nb of points in scans; pm3d ftriangles flush begin

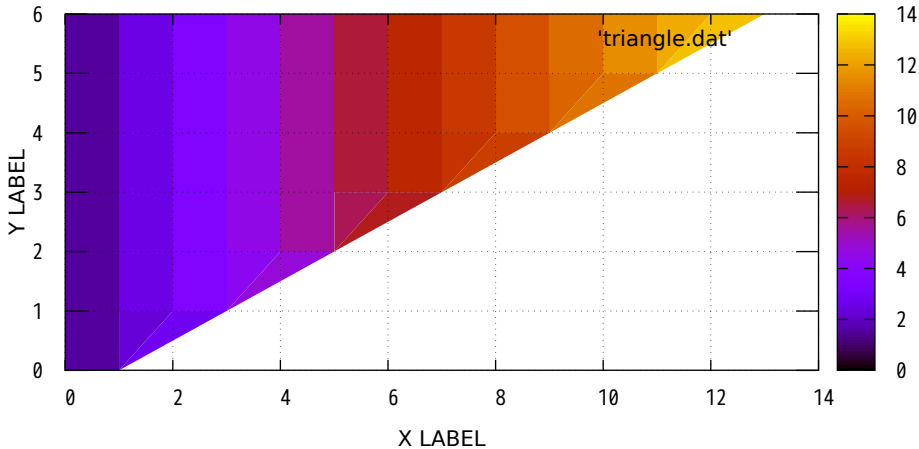

Data with different nb of points in scans; pm3d ftriangles flush center

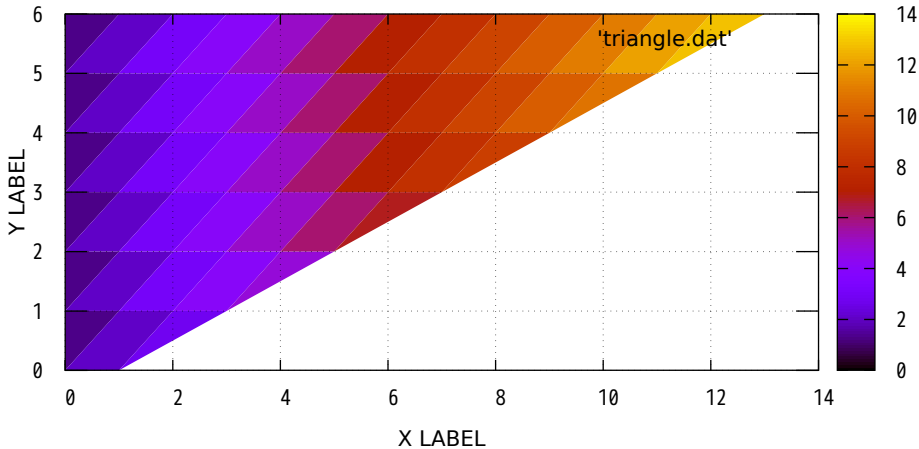



Data with different nb of points in scans; pm3d ftriangles flush end

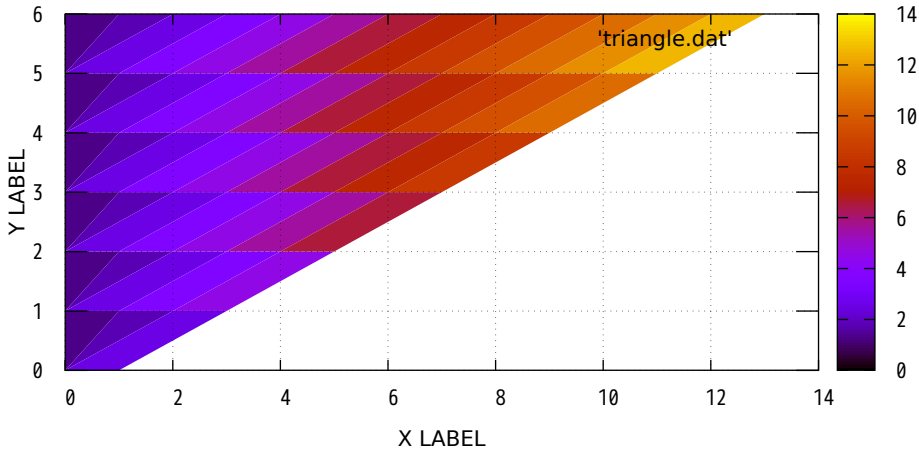

Using interpolation with datafile; pm3d map interpolate 2,1

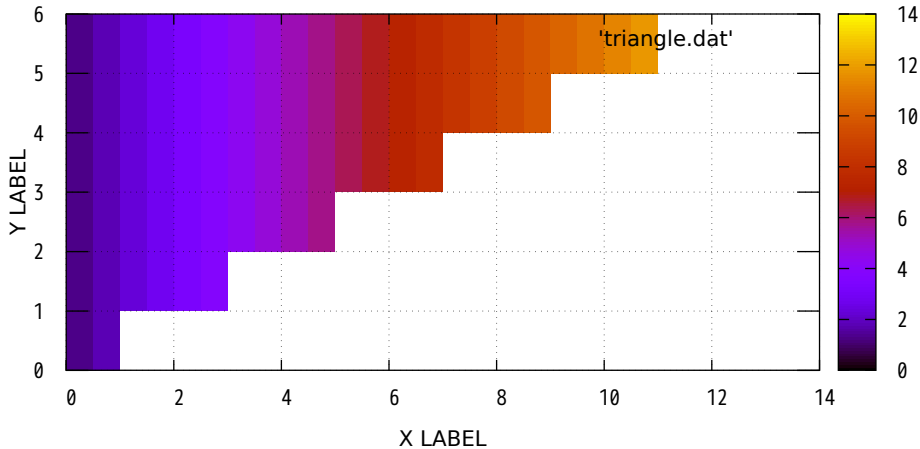

Using interpolation with datafile; pm3d map ftriangles interpolate 10,1

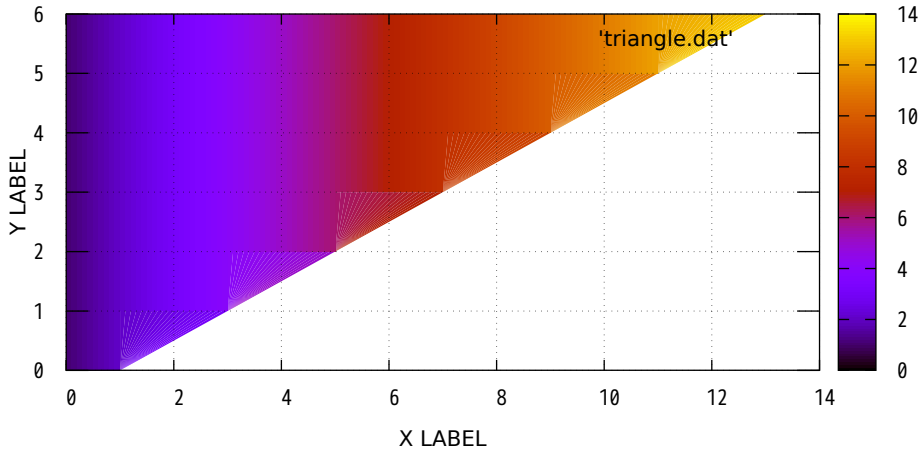

Using interpolation with datafile; pm3d at s ftriangles interpolate 10,1

'triangle.dat'

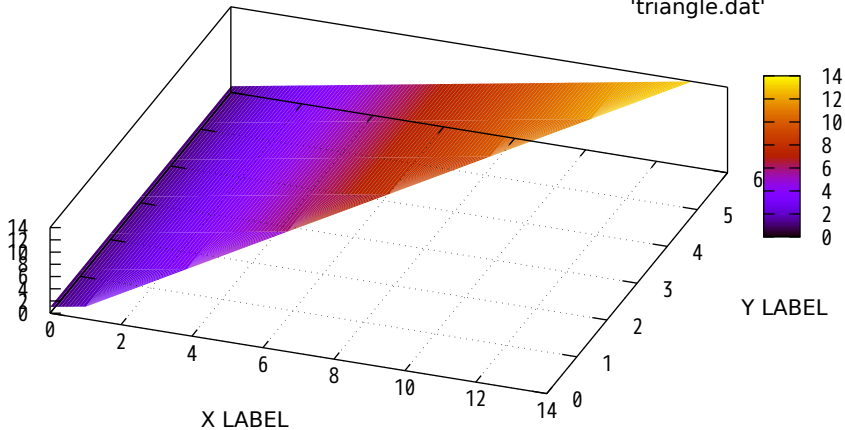

only for enhanced terminals: 'set format cb ...'

$$\text{abs}(x)^3 + \text{abs}(y)^3$$

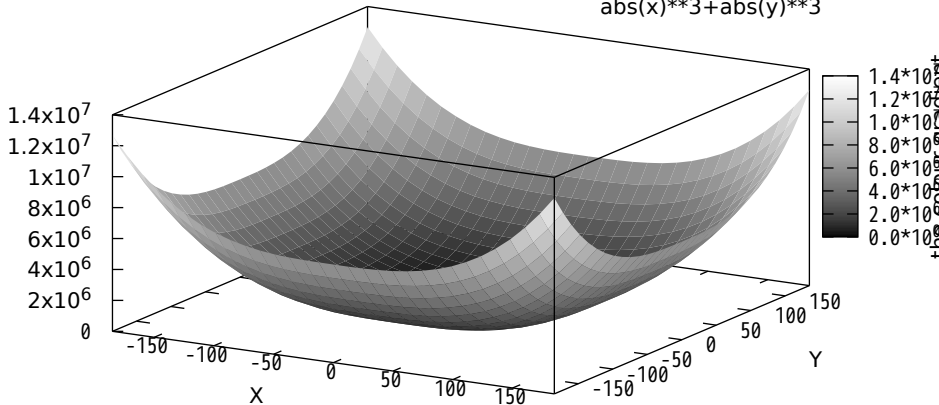

function 'x+y' using all colors available, 'set pal maxcolors 0'

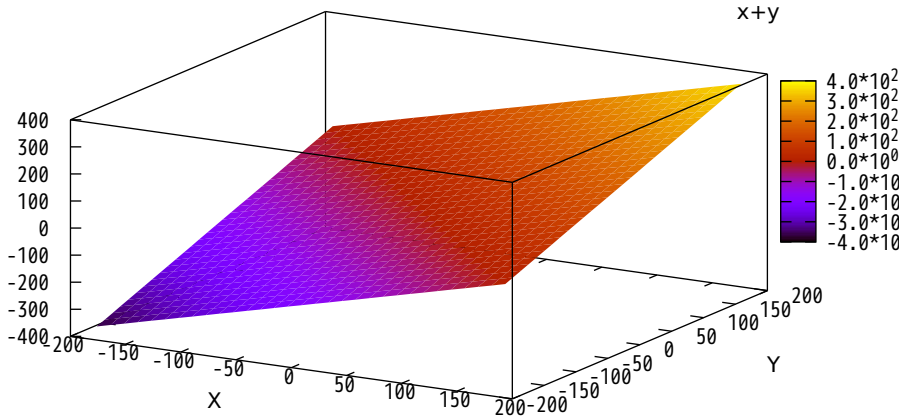

function 'x+y' using only 5 colors, 'set pal maxcolors 5'

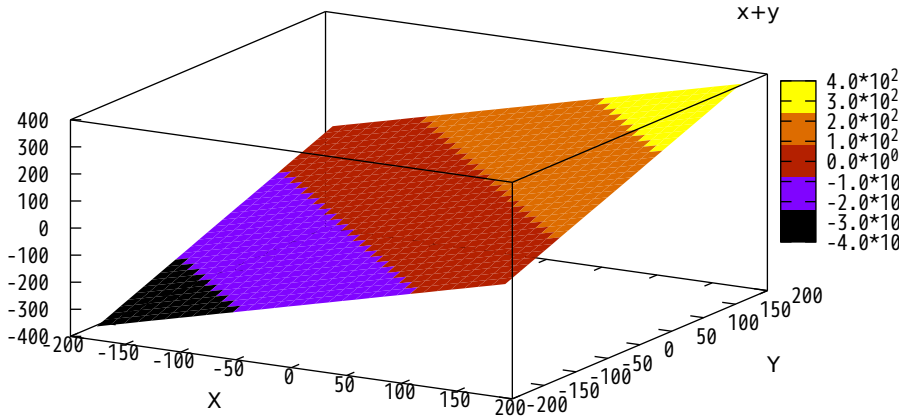

color lines: 'splot sin(y)/(y) with lines palette'

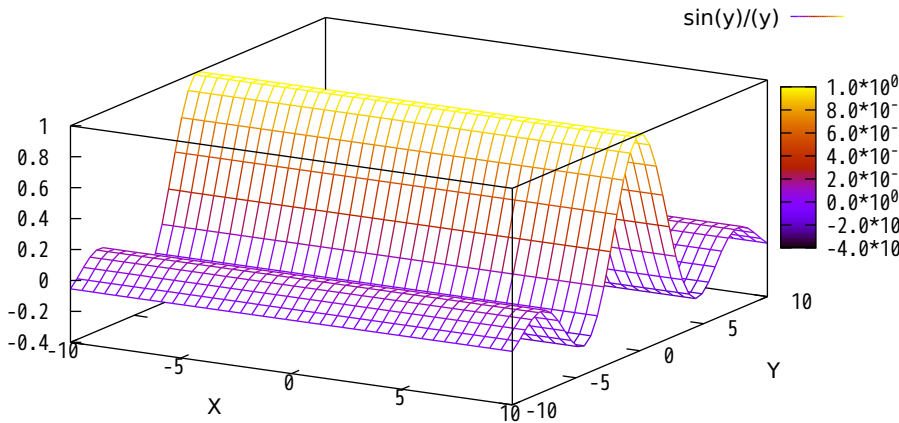



Demo for clipping of 2 rectangles comes now. The xrange is [0:2]...

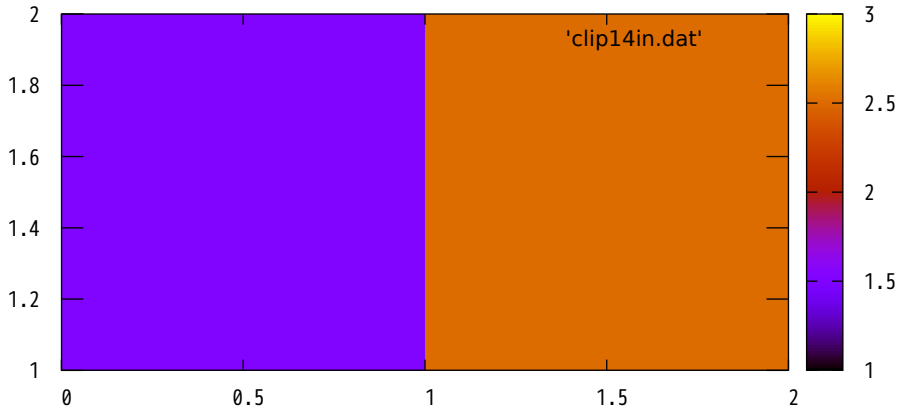

...and now xrange is [0:1.5] and 'set pm3d clip1in'

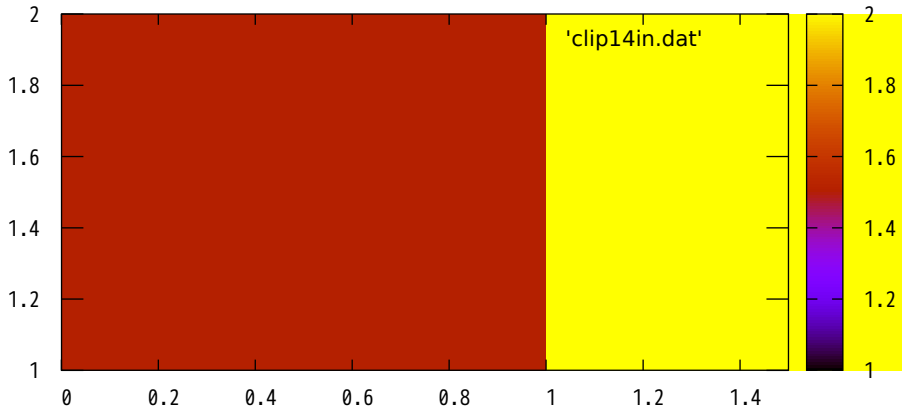

...now xrange is [0:1.5] and 'set pm3d clip4in'

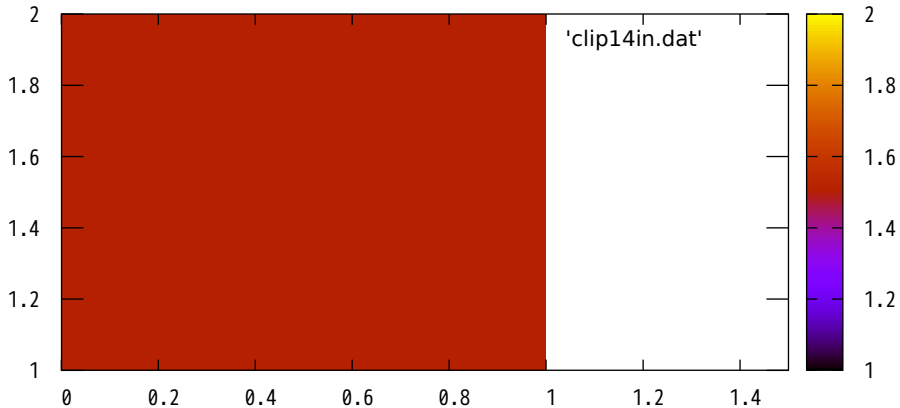

pm3d explicit mode --- coloring according to the 4th parameter of 'using'

'binary2' binary u 1:2:3:(\$2+(\$1+\$2)/10)

1+sinc(x\*4, y\*4) ———

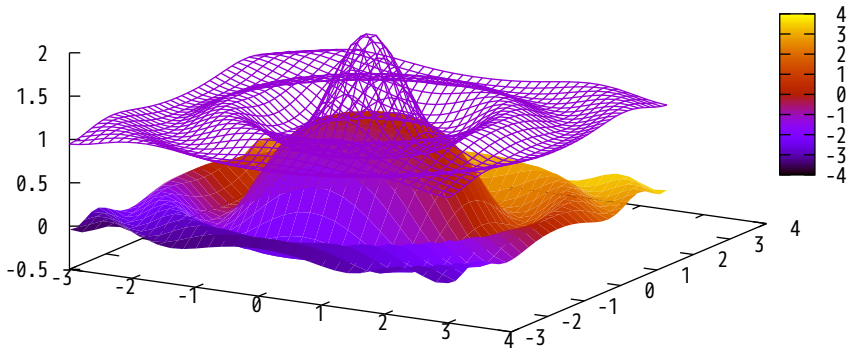

coloring according to the 3rd 'using' parameter (left) and to the z-value (bottom)

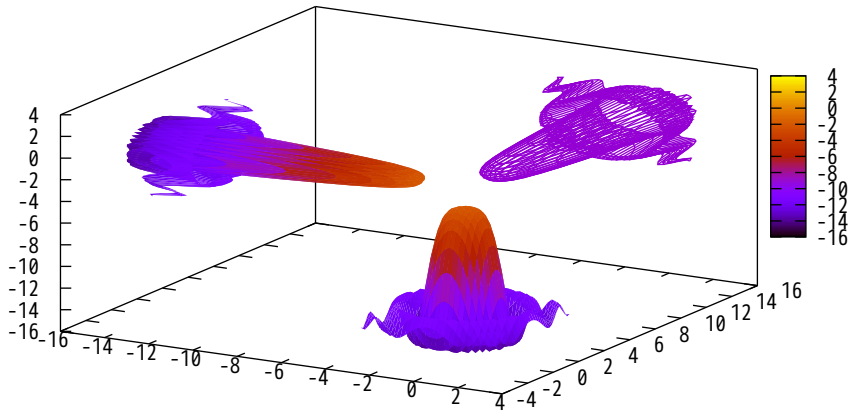

c3



set pm3d corners2color mode mean



c4



harmean



Original grid points

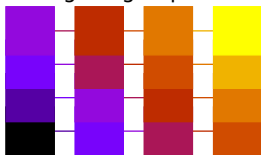

geomean



c1



median

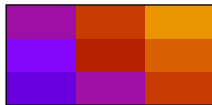

c2



# Palettes according to 'help palette rgbformulae'

traditional pm3d  
(black-blue-red-yellow)

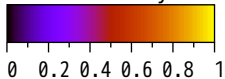

hot (black-red-yellow-white) AFM hot (black-red-yellow-white)

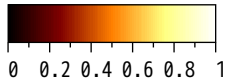
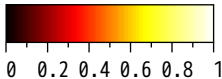

green-red-violet

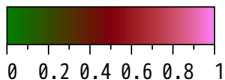

color printable on gray

(black-blue-violet-yellow-red-white)

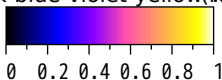

HSV model

(red-yellow-green-cyan-blue-magenta)

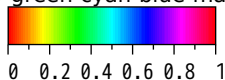

ocean (green-blue-white)

try also other permutations

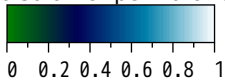

rainbow (blue-green-yellow-red)

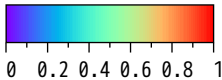

gray palette

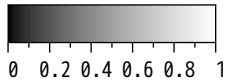

set palette defined

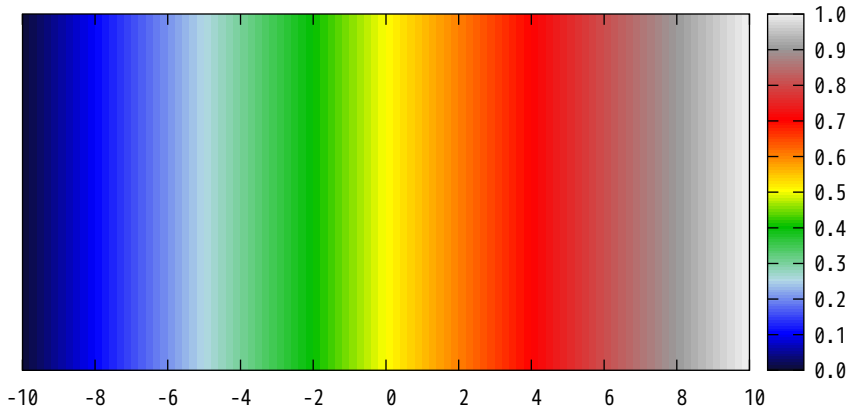



set palette defined (0 0 0 0, 1 0 0 1, 3 0 1 0, 4 1 0 0, 6 1 1 1)

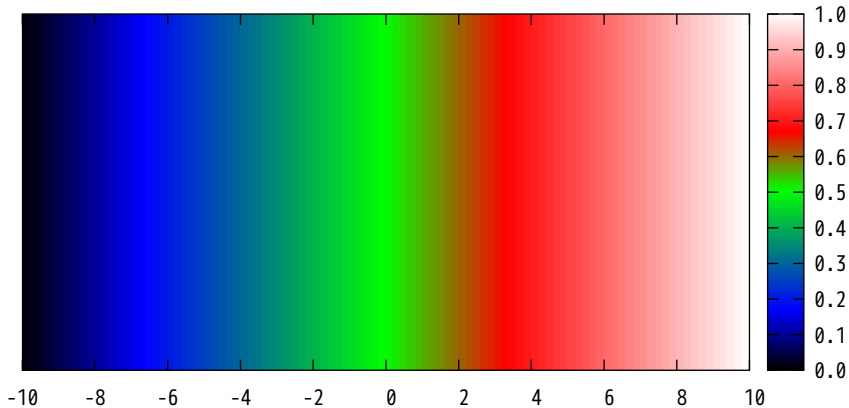

set palette defined ( 0 "green", 1 "blue", 2 "red", 3 "orange" )

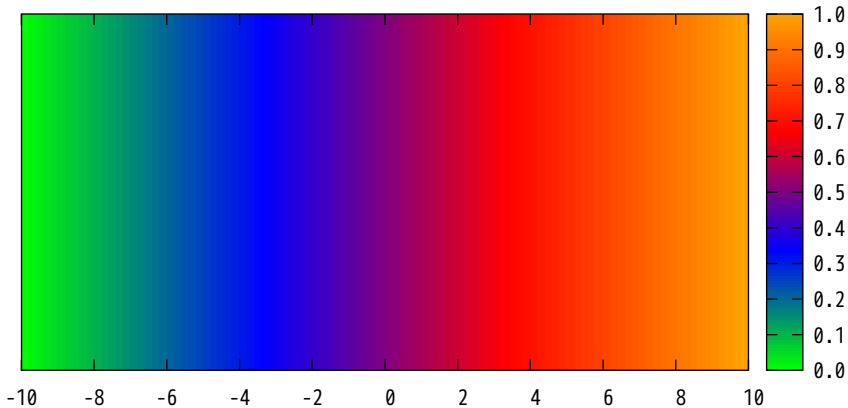

set palette defined ( 20 "#101010", 30 "#ff0000", 40 "#00ff00", 50 "#e0e0e0" )

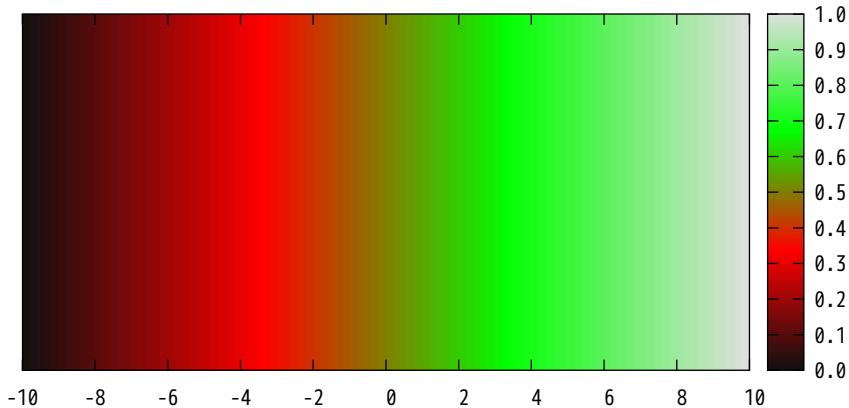

set palette defined ( 0 0 0 0, 1 1 1 1 )

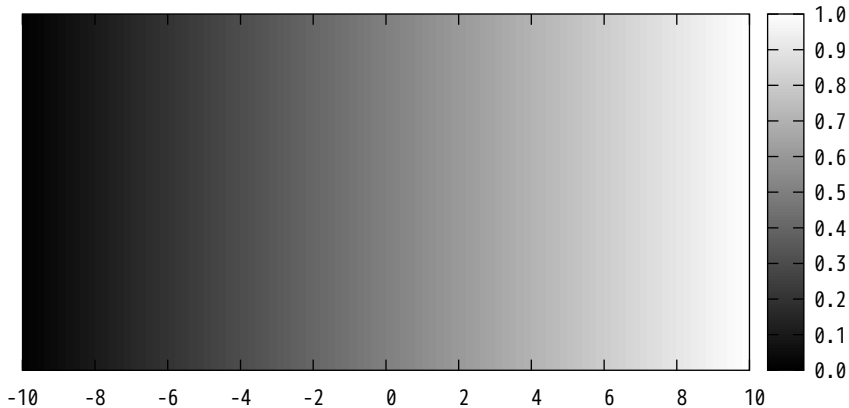

set palette model HSV defined ( 0 0 1 1, 1 1 1 1 )

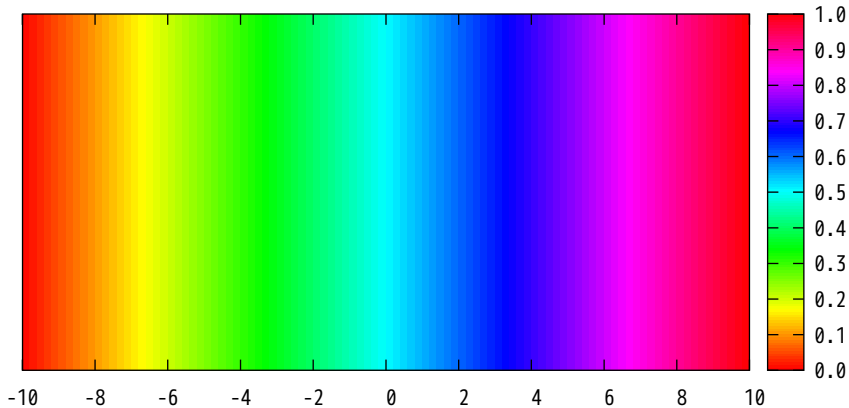

set palette model RGB defined

(0 'green', 1 'dark-green', 1 'yellow', 2 'dark-yellow', 2 'red', 3 'dark-red' )

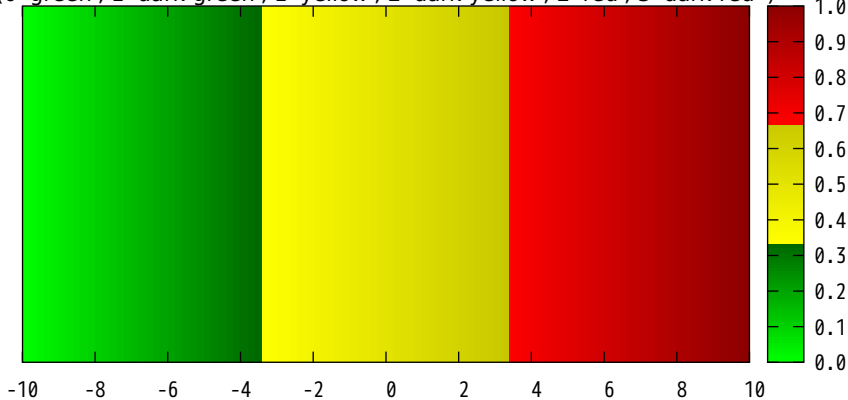

set palette file "-" (file with 3 columns)

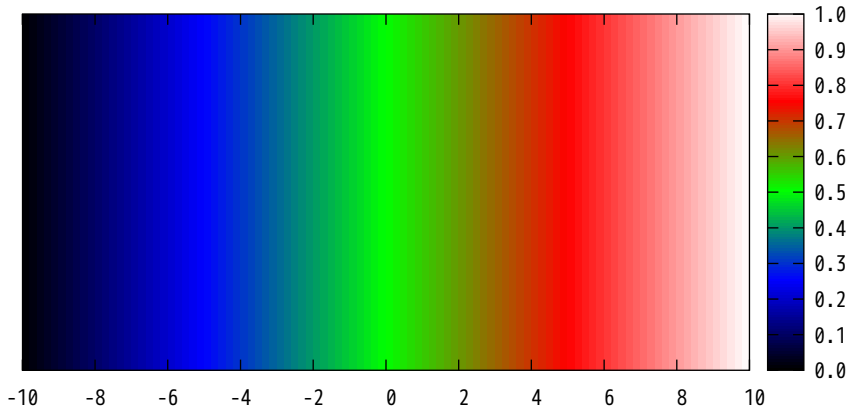

set palette file "-" (file with 4 columns)

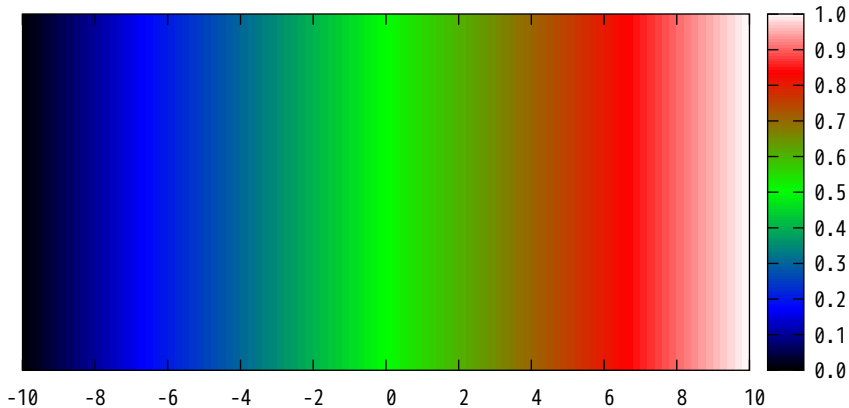



set palette file "-" using 1:2:(\$1+\$2)/2

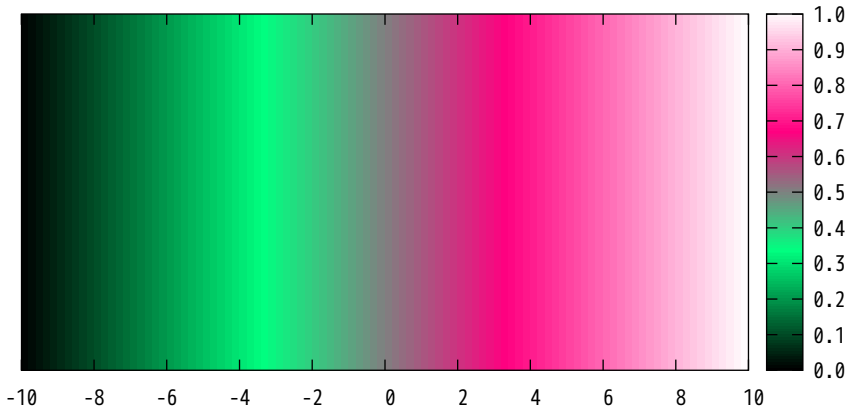

set palette model RGB rgbformulae 7,5,15

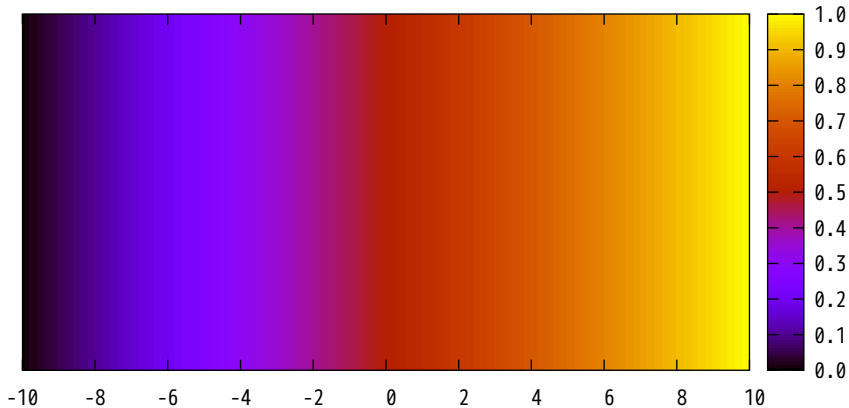

set palette model HSV rgbformulae 7,5,15

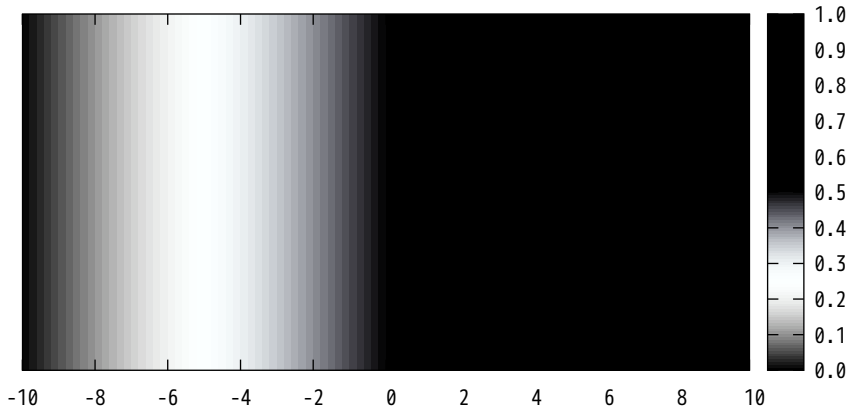

set palette model XYZ rgbformulae 7,5,15

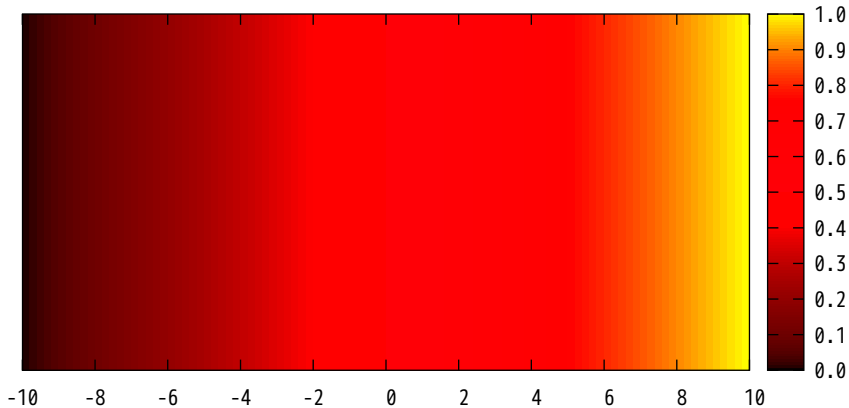

set palette model CMY rgbformulae 7,5,15

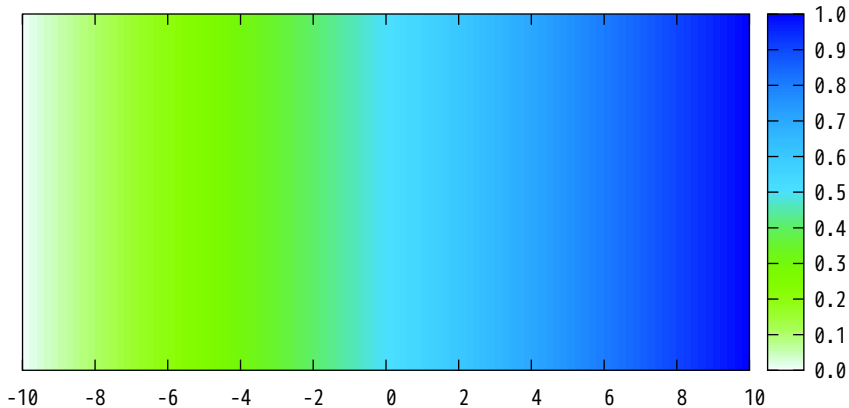

set palette model HSV rrgbformulae 3,2,2

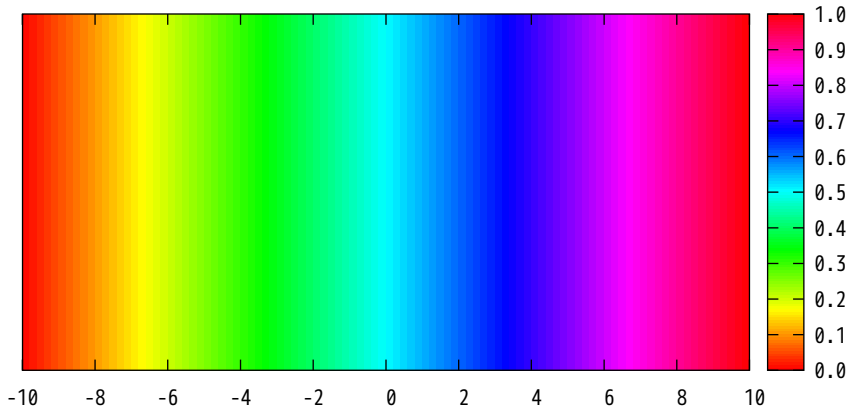

set palette functions gray, gray, gray

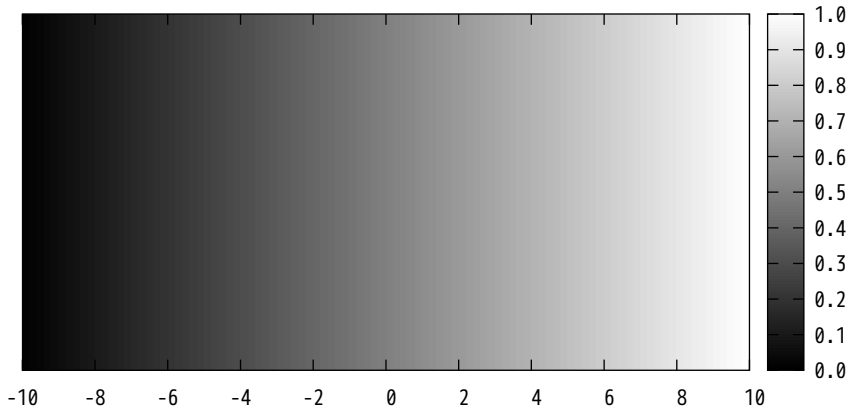

set palette functions sqrt(gray), gray\*\*3, sin(gray\*2\*pi) <--> 7,5,15

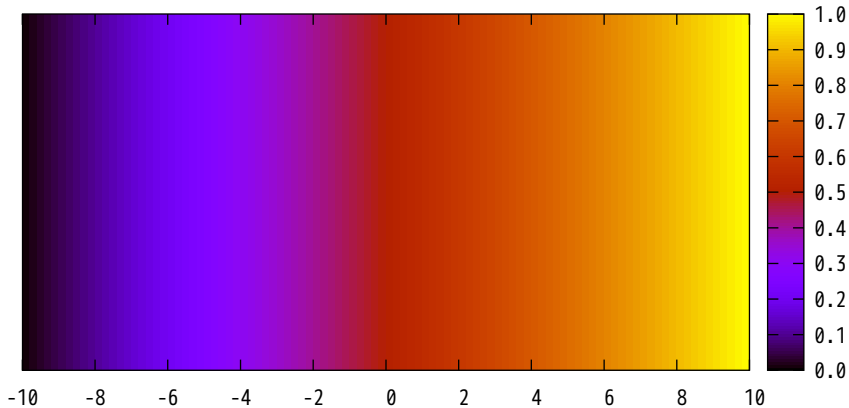



set palette rgbformulae 7,5,15

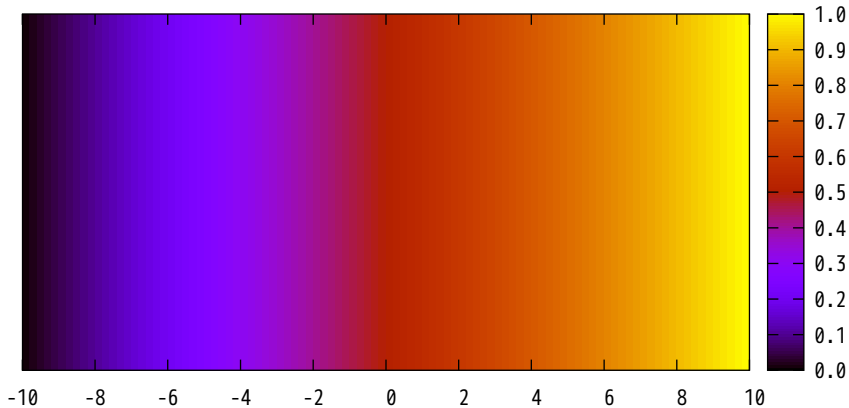

```
set palette model XYZ functions model XYZ gray**0.35, gray**0.5, gray**0.8
```

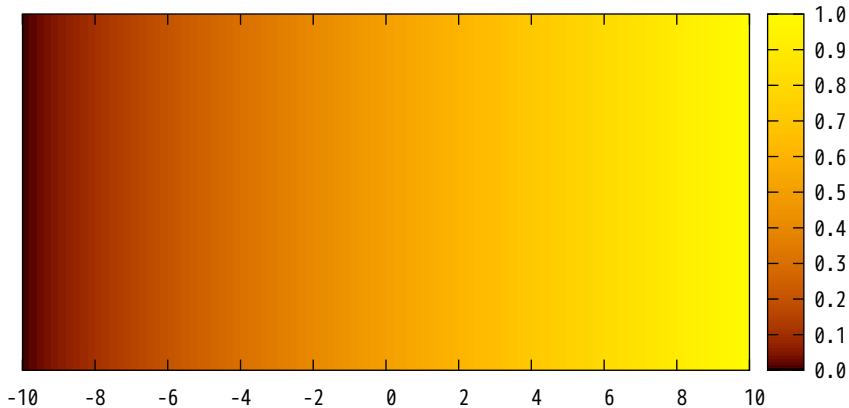

set palette model RGB functions

$4*x*(1-\text{theta}(x-0.25))$ ,  $0.5*\text{theta}(x-0.25)*(1-\text{theta}(x-0.5))$ ,  $x$

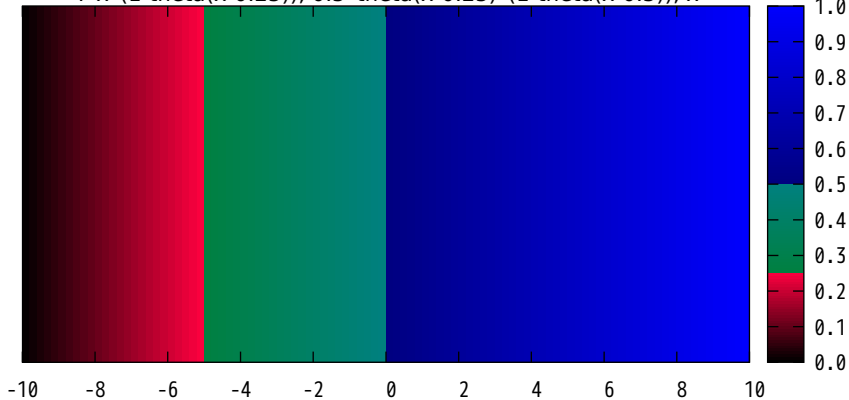

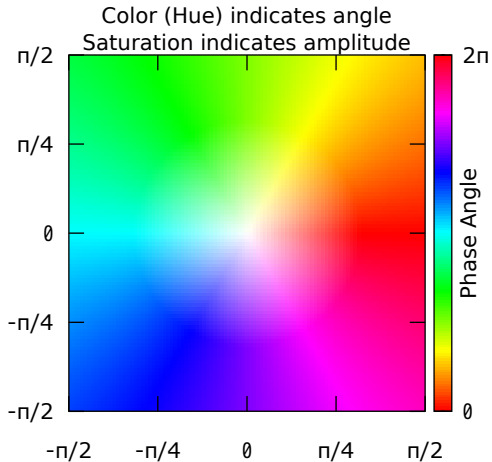

$\text{asin}(x + iy)$

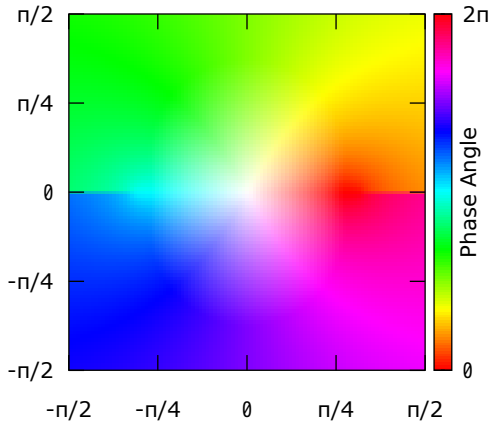

$\text{acos}(x + iy)$

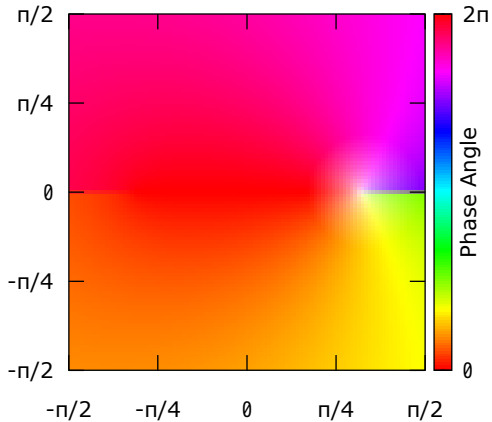

$\text{atan}(x + iy)$

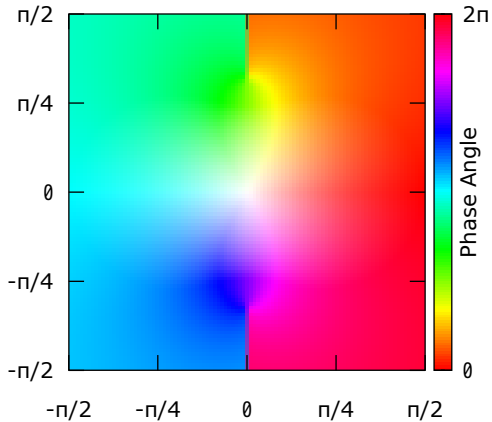

$\sinh(x + iy)$

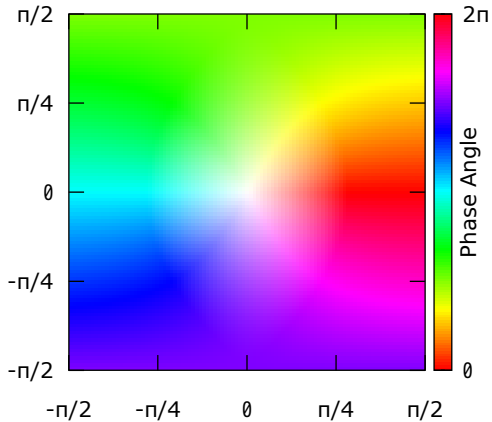



$\cosh(x + iy)$

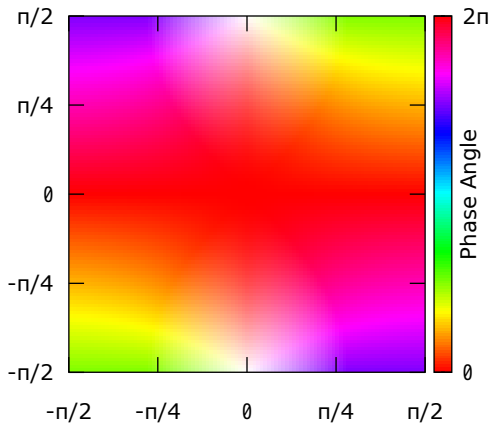

$\tanh(x + iy)$

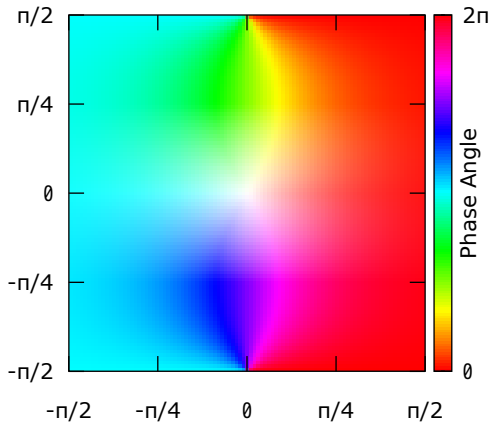

$\operatorname{asinh}(x + iy)$

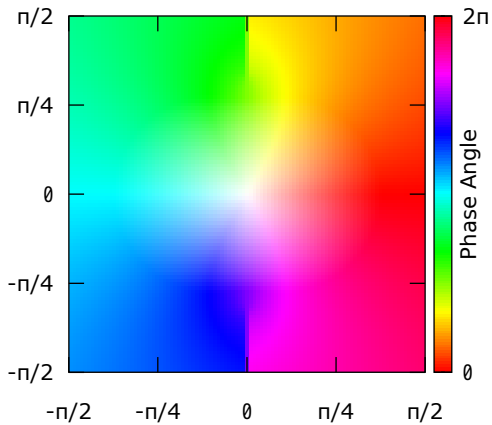

$\operatorname{acosh}(x + iy)$

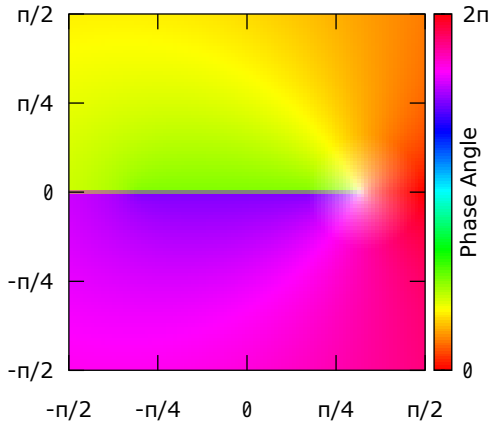

$\operatorname{atanh}(x + iy)$

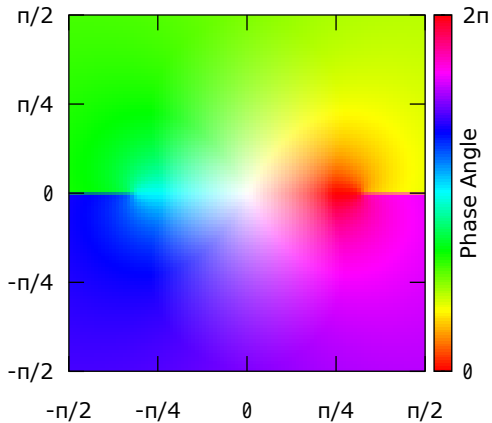

$\operatorname{atanh}(x + iy)$

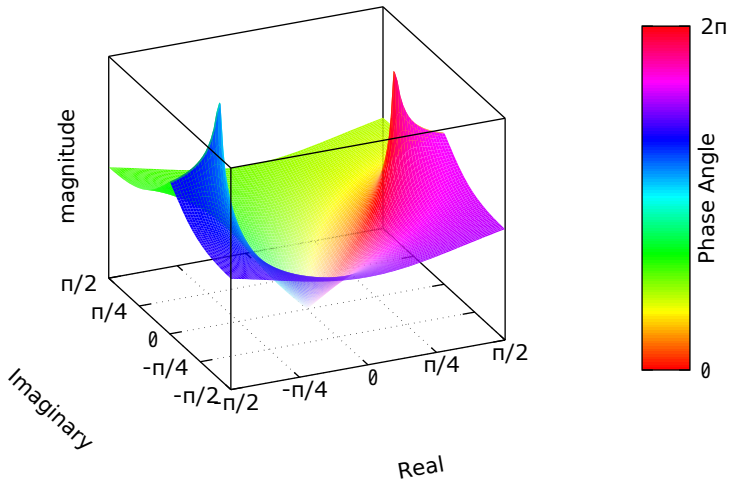

Heat Map generated from a file containing Z values only

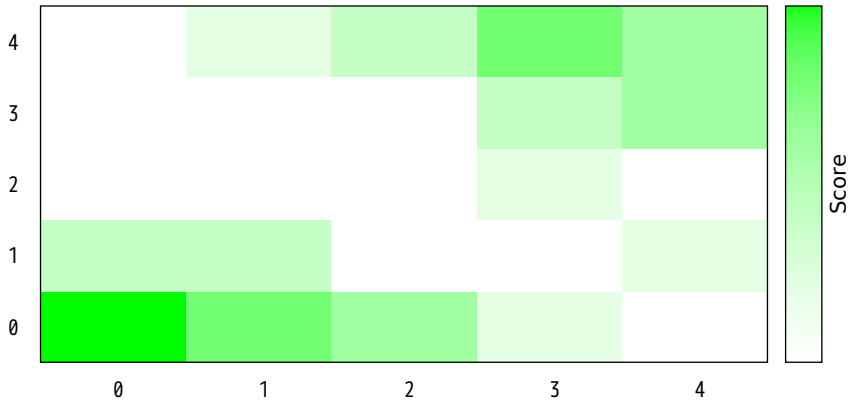

Heat Map generated by 'plot' from a stream of XYZ values  
NB: Rows must be separated by blank lines!

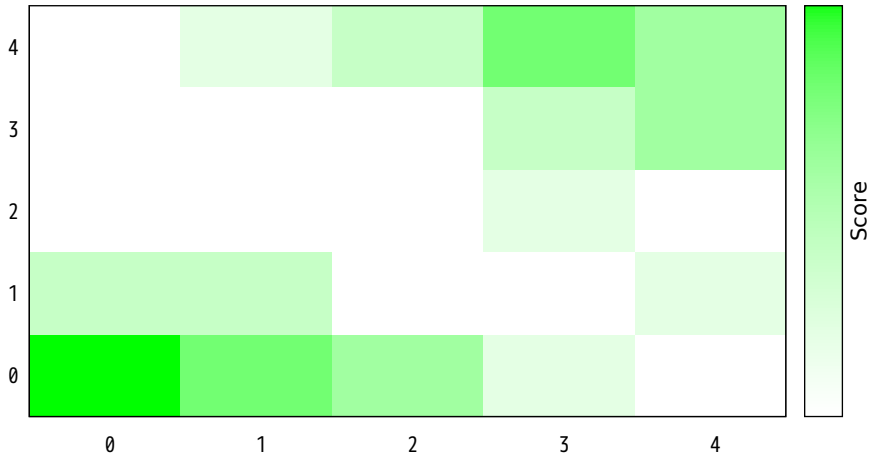



Heat map with non-zero pixel values written as labels

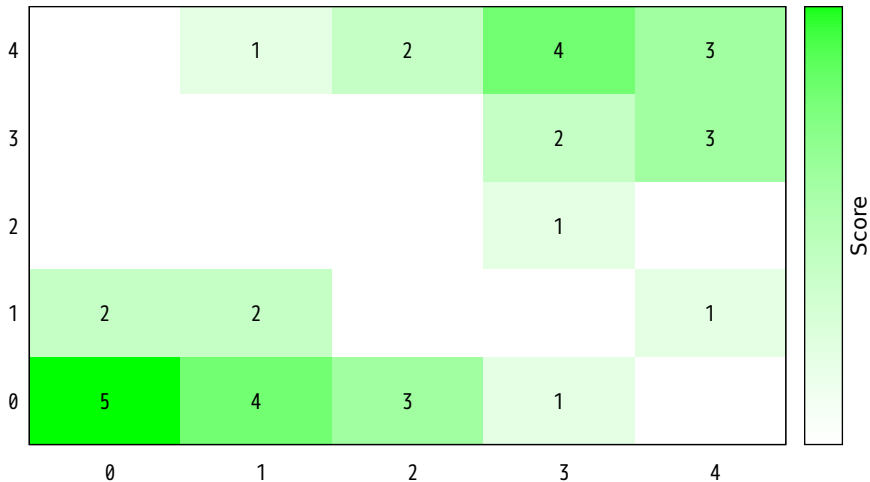

Heat map from csv data with column and row labels

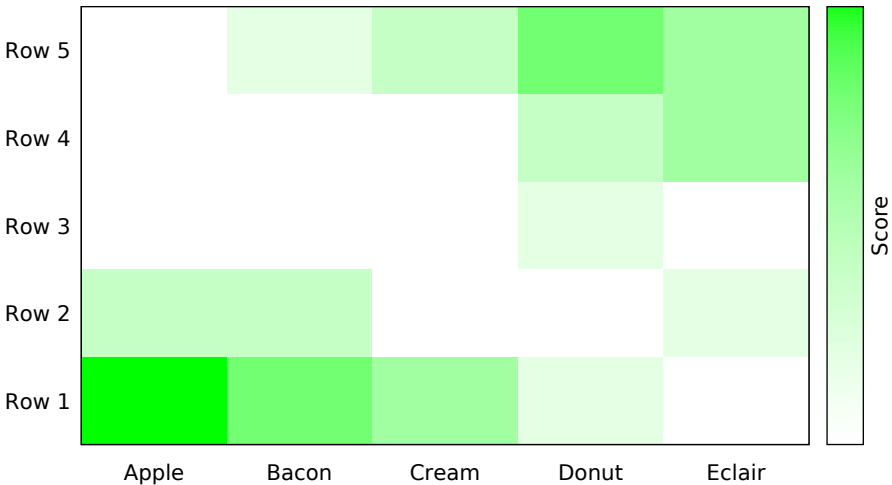

Compare 'image' and 'image pixels' modes  
plot with image plot with image pixels

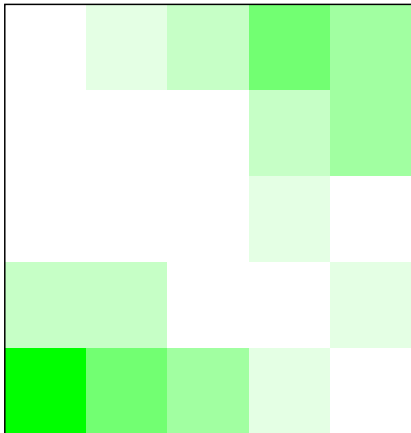
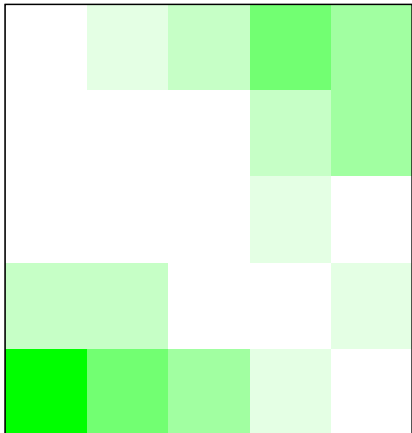

4D data (3D Heat Map)  
Independent value color-mapped onto 3D surface

4 data columns x/y/z/color

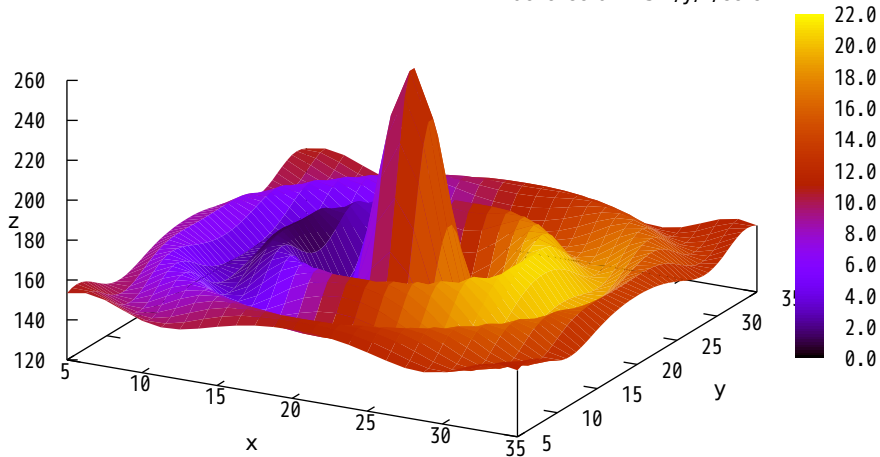

# 4D data (3D Heat Map)

Z is contoured. Independent value is color-mapped

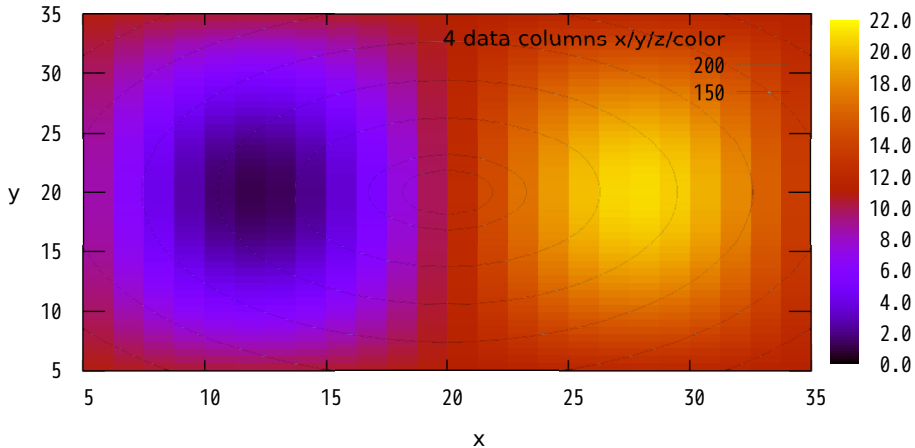

## Data file contains labeled ascii matrices

Y range should be the same

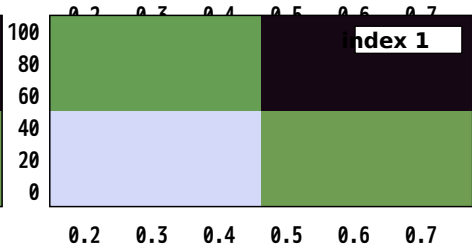
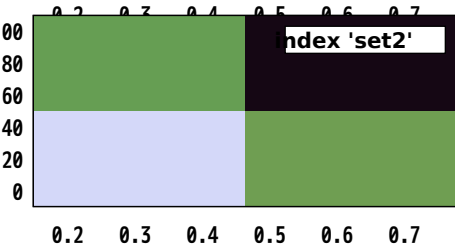
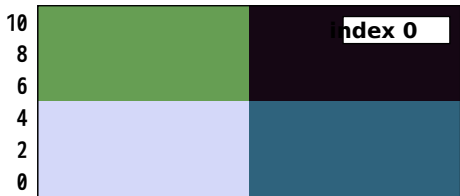

Full 7x7 matrix

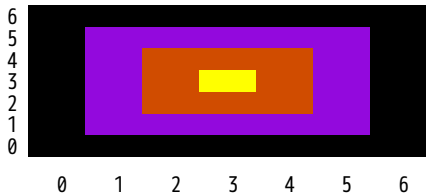

Subsample rows by every  $::2::4$

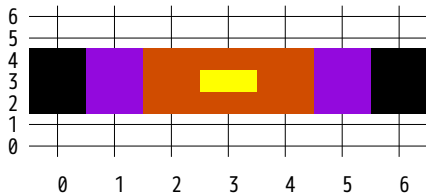

Subsample columns by every  $::2::4$

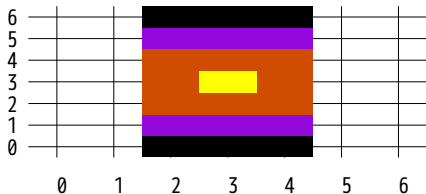

Sample alternate columns by every 2

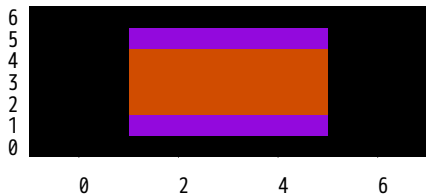

gamma = 0.75

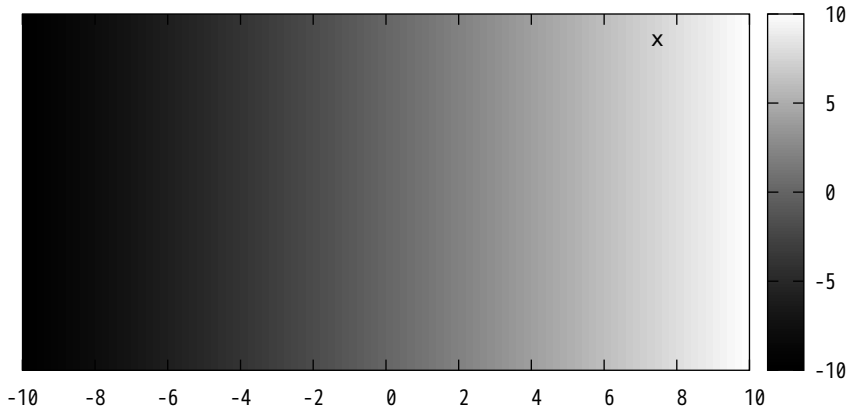



gamma = 1.0

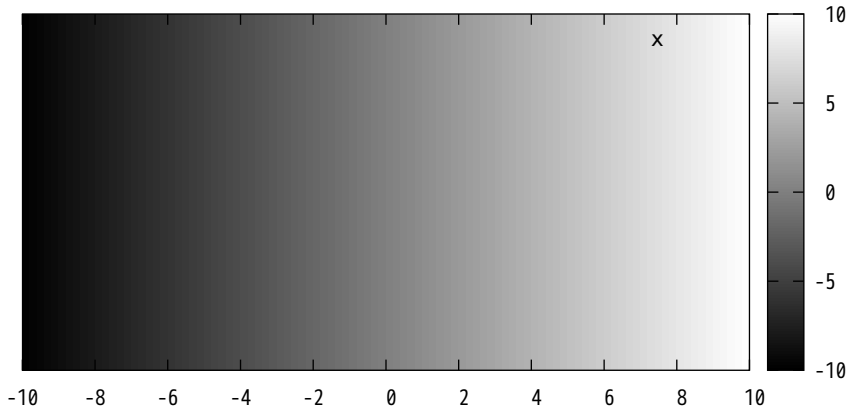

gamma = 1.25

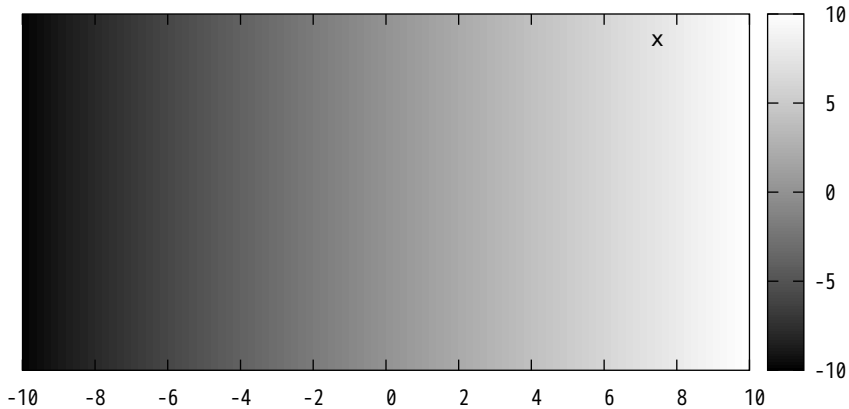

gamma = 1.5

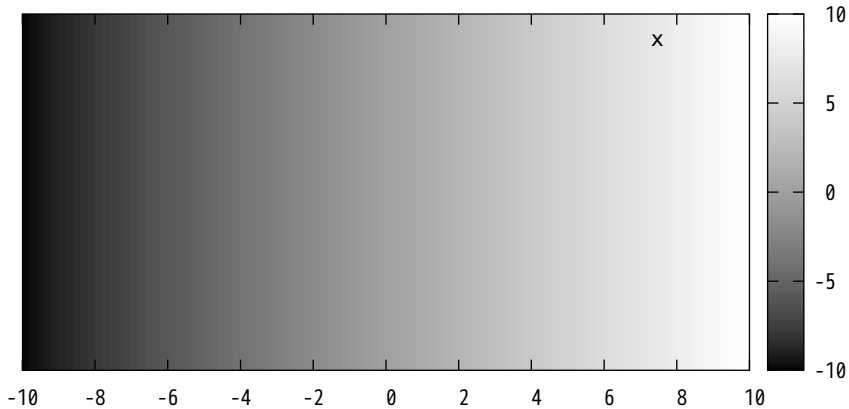

gamma = 1.75

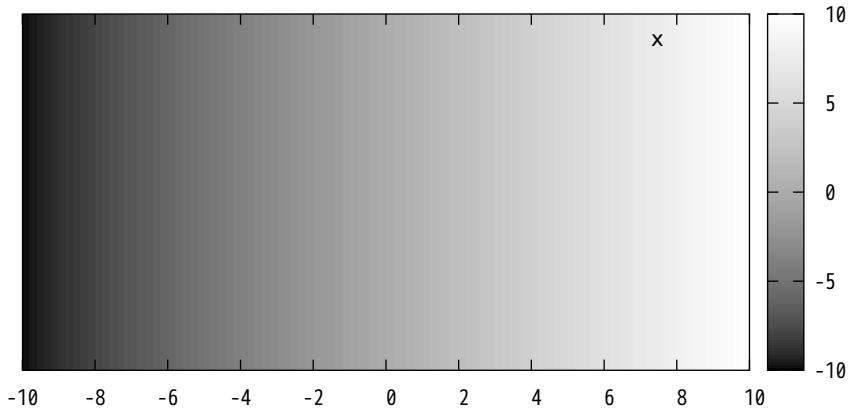

gamma = 2.0

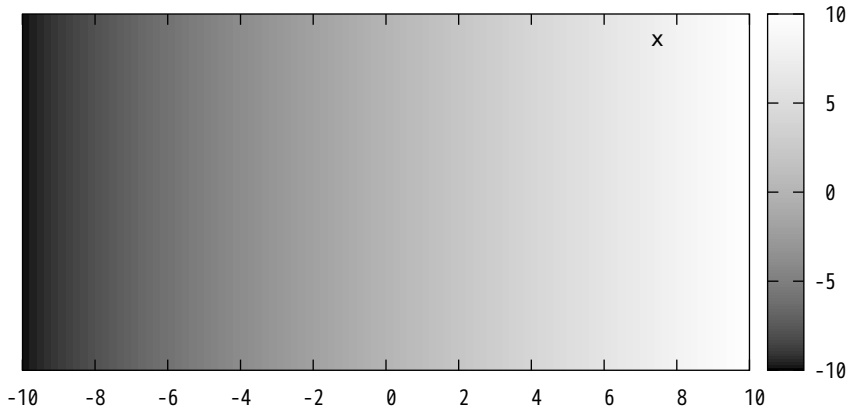

## Mixing pm3d surfaces with hidden-line plots

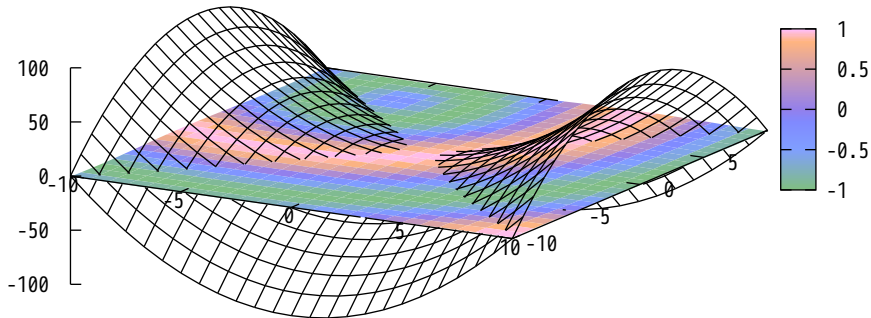

## Mixing image surface with hidden-line plots

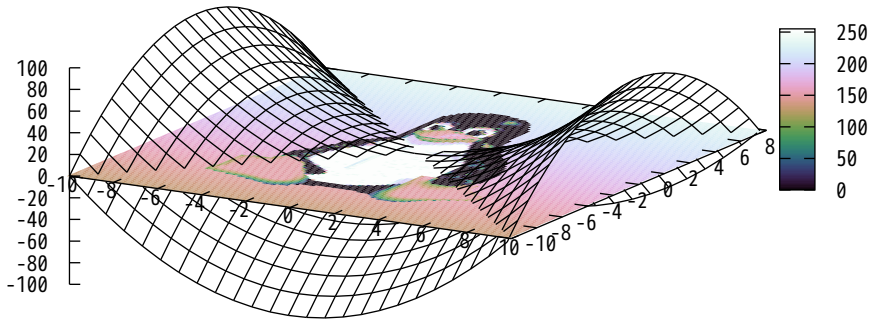

## Interlocking Tori

PM3D surface  
no depth sorting

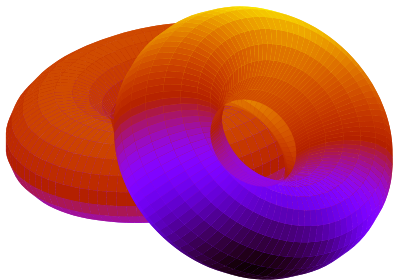

PM3D surface  
depth sorting

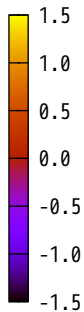
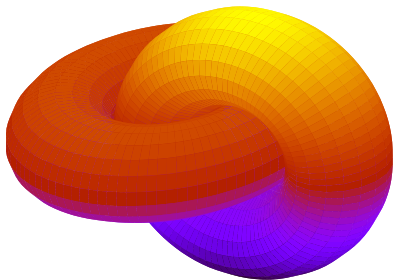



Textcolor options in 2D plot (notice this title in color)

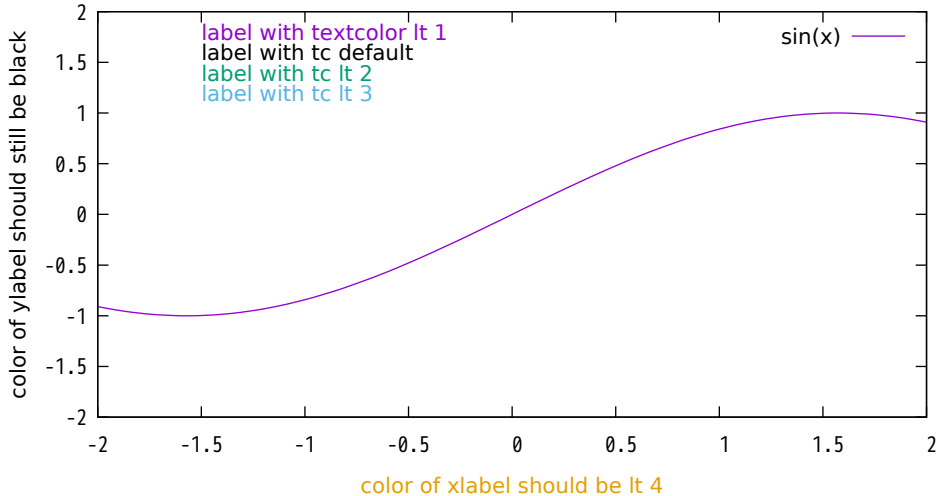

Textcolor options in plot (notice this title in color)

textcolor lt 1  
tc lt 2  
tc lt 3  
textcolor default  
textcolor cb 5  
tc cb 0  
tc cb -5  
textcolor frac 7  
tc frac .25

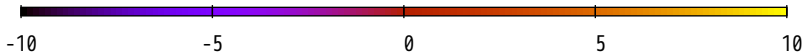
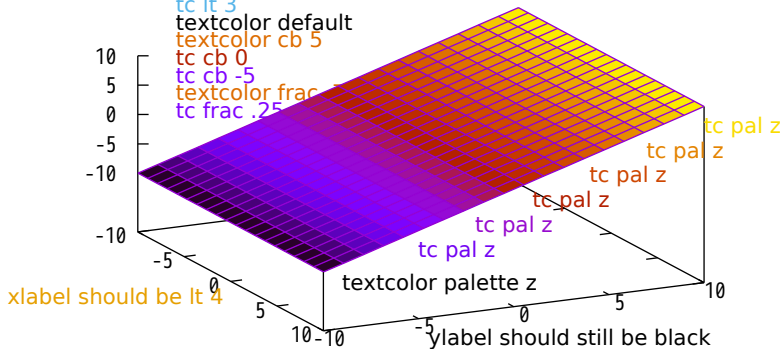
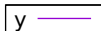



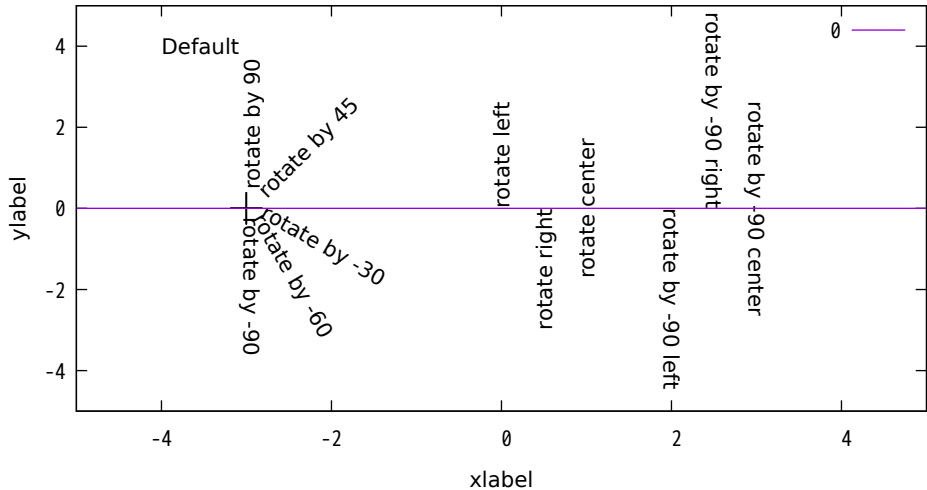

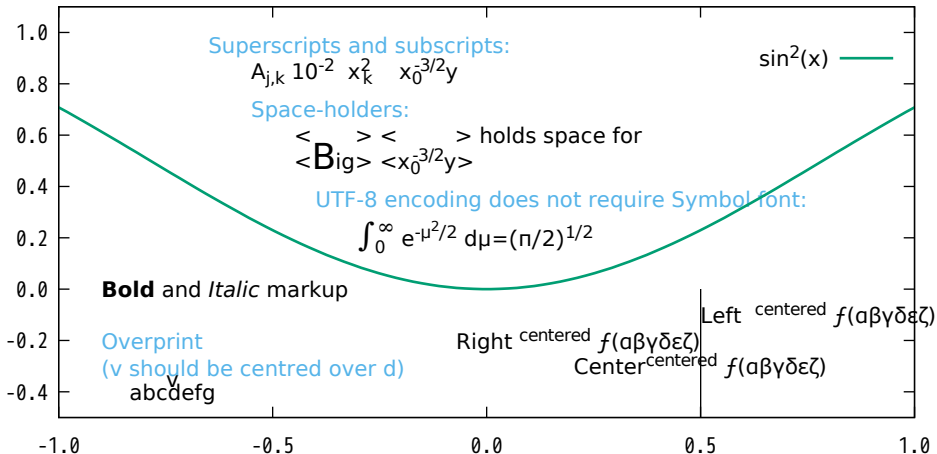

Rotation of label text







Demo of enhanced text mode using a single UTF-8 encoded font  
There is another demo that shows how to use a separate Symbol font



## Terminal's native dashtypes

dt 1	
dt 2	
dt 3	
dt 4	
dt 5	
dt 6	
dt 7	
dt 8	
dt 9	
dt 10	

## Custom dashtypes

dt "."	
dt "-"	
dt "._"	
dt "..-"	
dt (50,6,2,6)	

## Terminal's native dashtypes

dt 1 

dt 2 

dt 3 

dt 4 

dt 5 

dt 6 

dt 7 

dt 8 

dt 9 

dt 10 

## Custom dashtypes

dt "." 

dt "-" 

dt ".\_" 

dt "..- " 

Top: plot with vectors arrowstyle 1, Bottom: explicit arrows

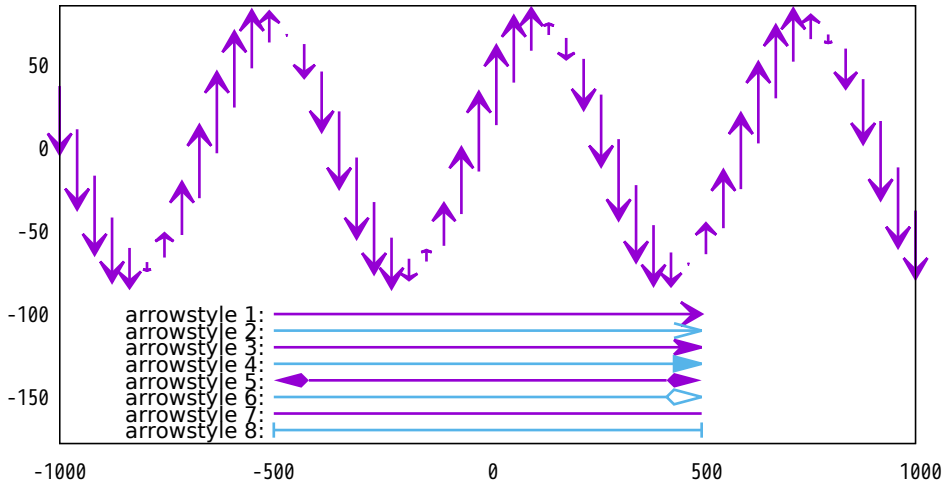

Top: plot with vectors arrowstyle 2, Bottom: explicit arrows

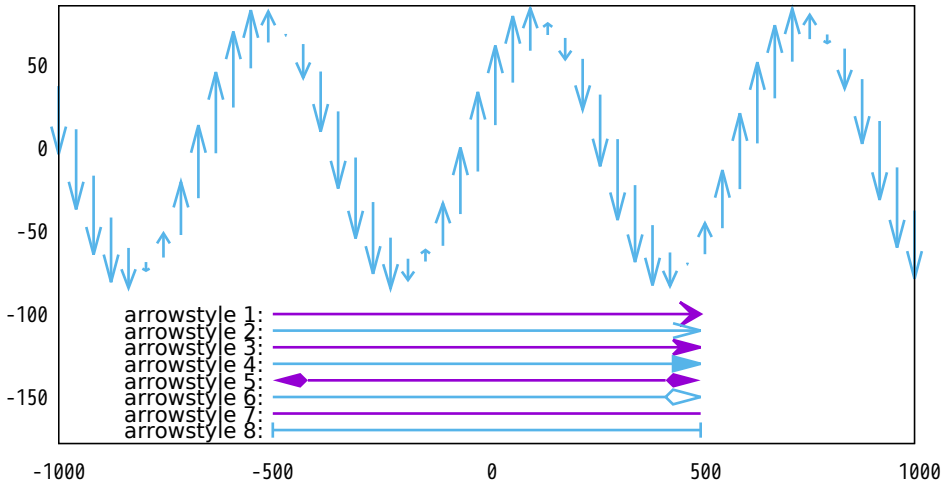



Top: plot with vectors arrowstyle 3, Bottom: explicit arrows

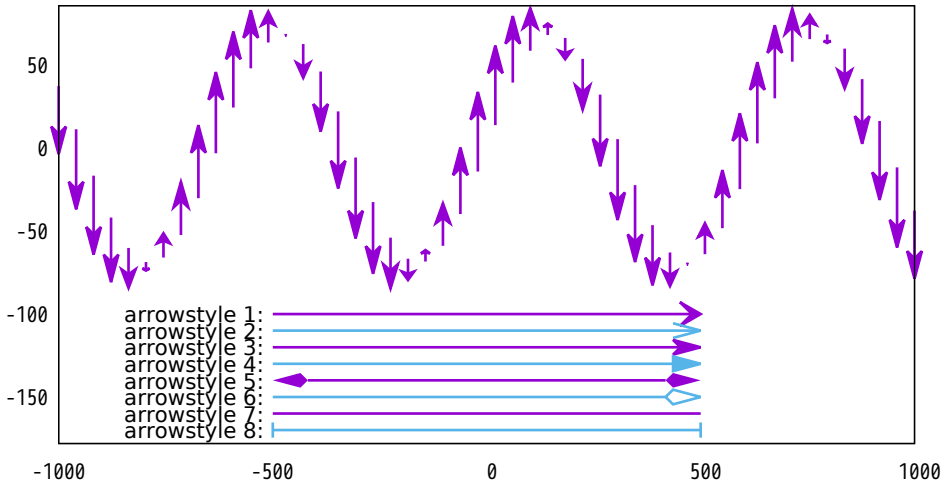

Top: plot with vectors arrowstyle 4, Bottom: explicit arrows

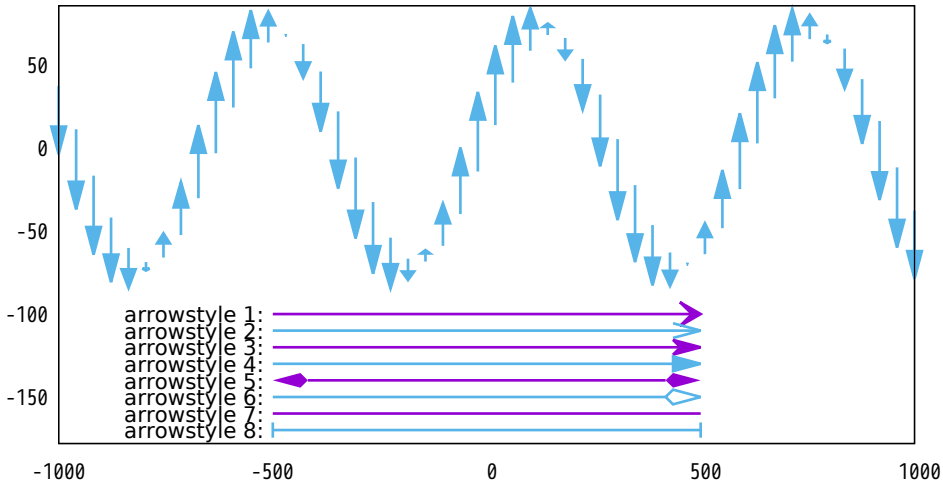

Top: plot with vectors arrowstyle 5, Bottom: explicit arrows

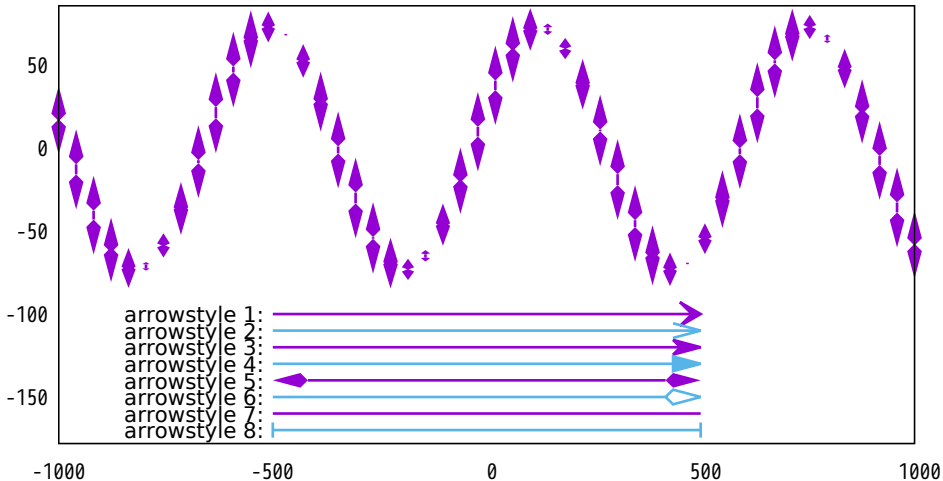

Top: plot with vectors arrowstyle 6, Bottom: explicit arrows

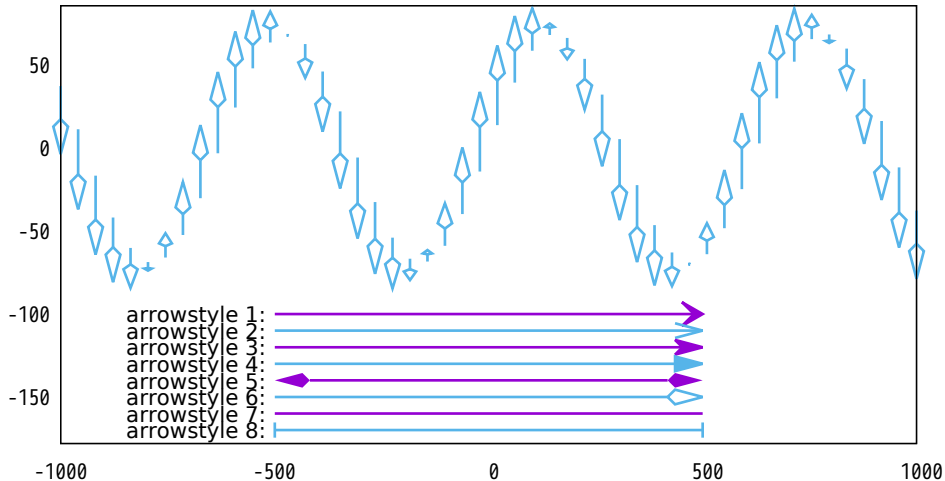

Top: plot with vectors arrowstyle 7, Bottom: explicit arrows

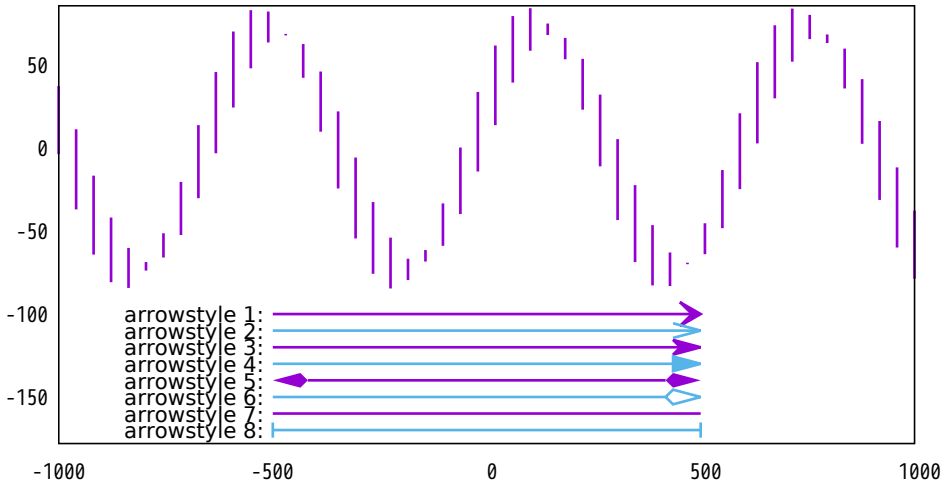

Top: plot with vectors arrowstyle 8, Bottom: explicit arrows

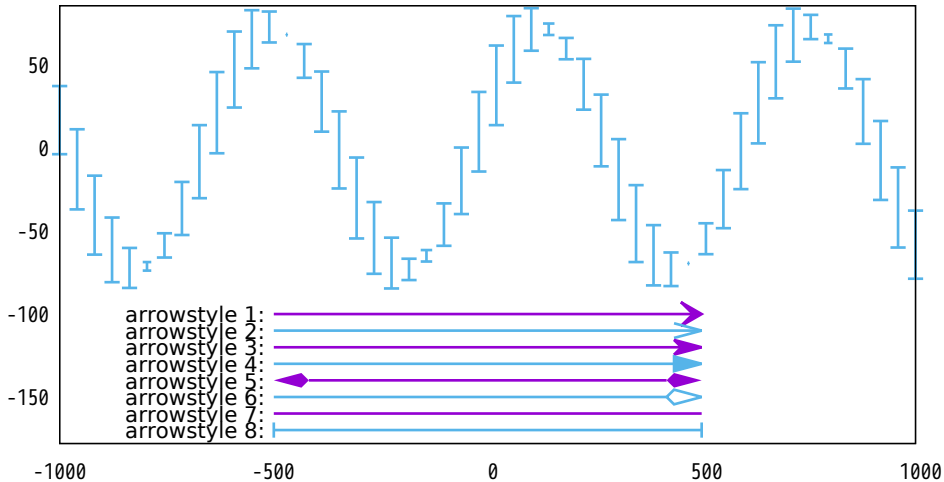

Plot 'file' with vectors <arrowstyle>

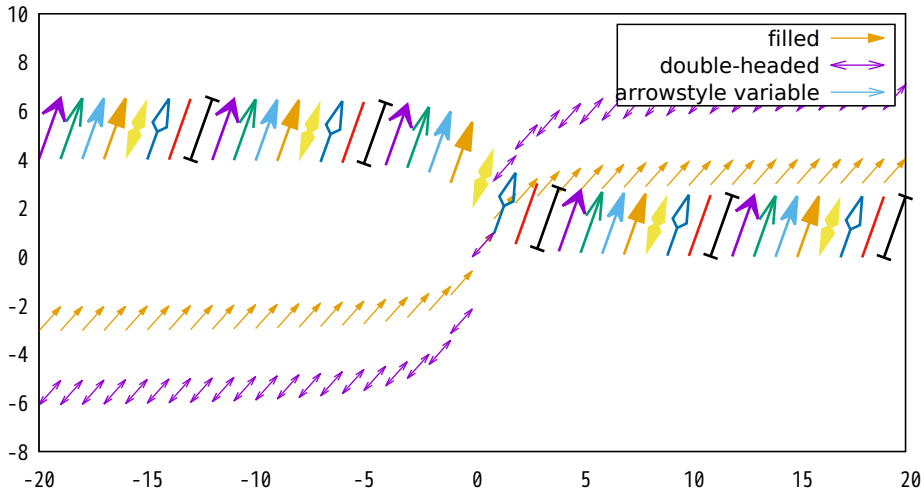

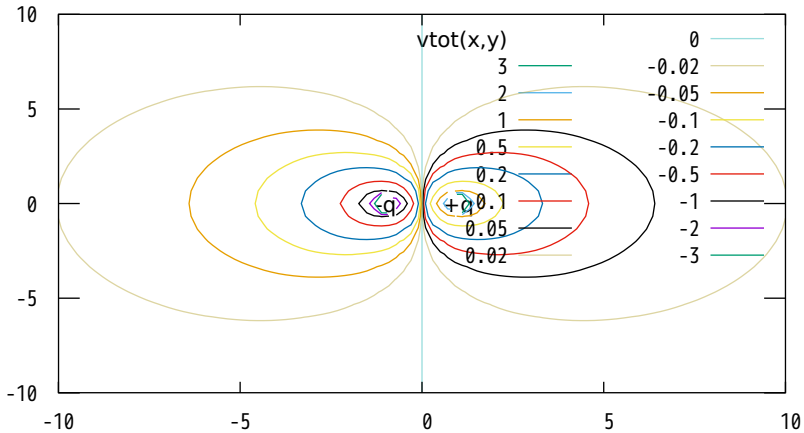



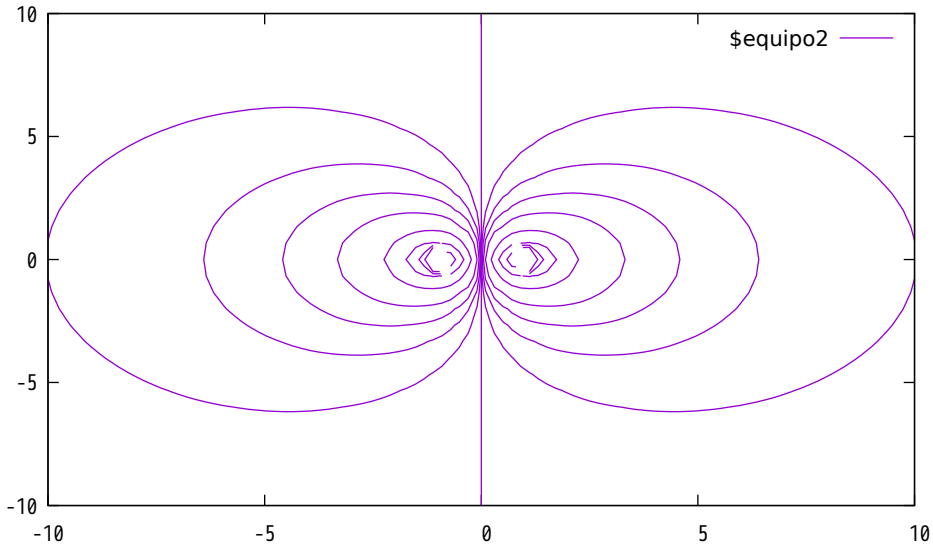

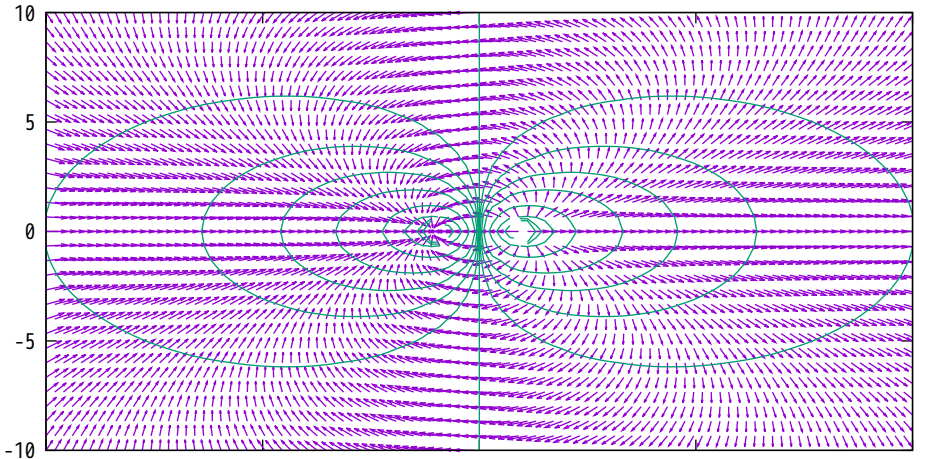

-10

→  $\vec{f}$  `$field2xy u 1:2:(coef* $\frac{\partial}{\partial x_1}(\phi_1, \phi_2)$ ):(coef* $\frac{\partial}{\partial y_1}(\phi_1, \phi_2)$ )`

— `$equipo2`

10

fixed size arrowheads for very short vectors

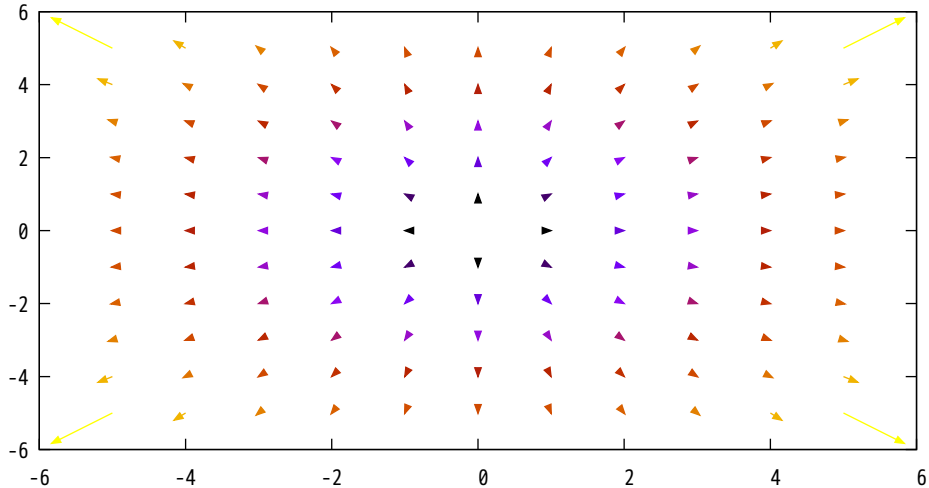

Default tics settings

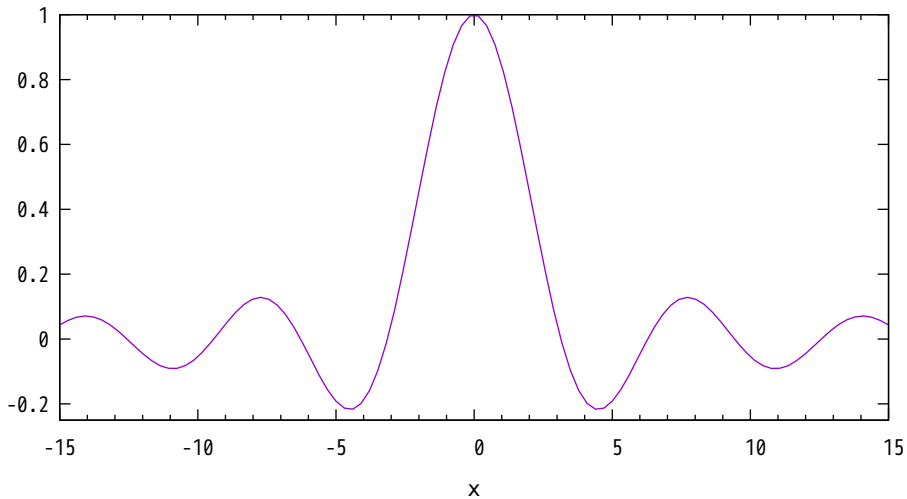

Different modification of tics settings

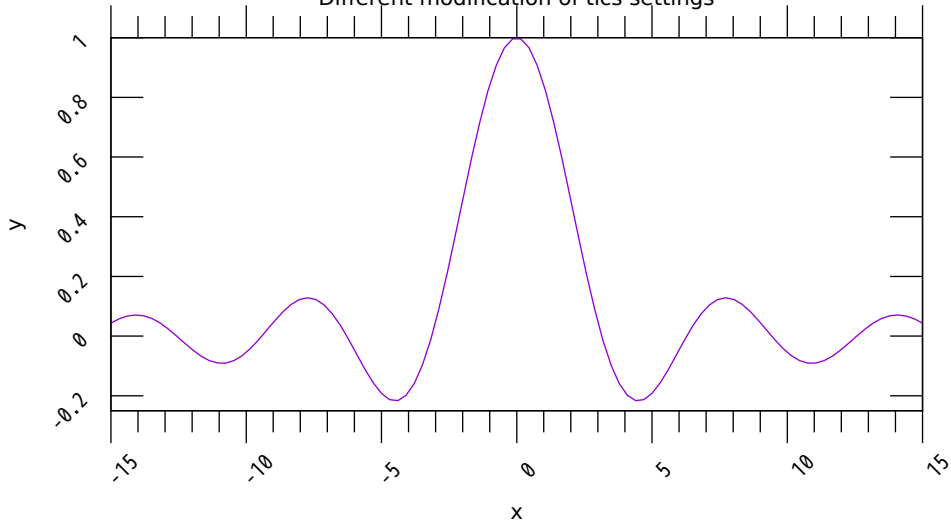

Different modification of tics settings

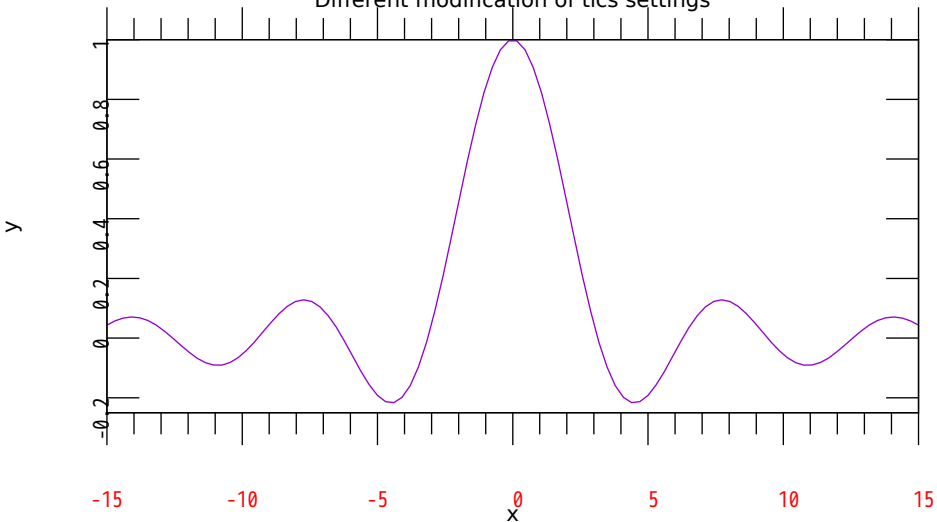

Modification of tics settings (pm3d map with colorbar)

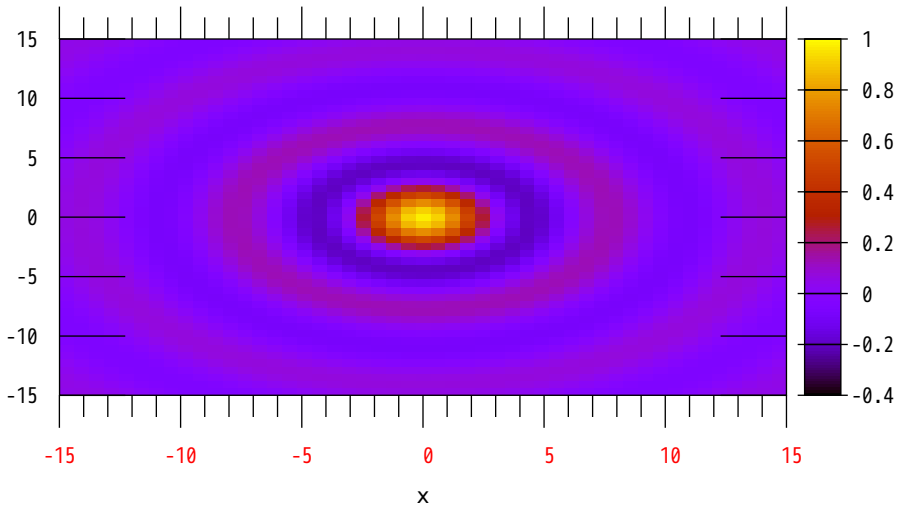

Nothing interesting here, just a unit test for volatile, skip, and refresh

"whale.dat" skip 5 volatile —

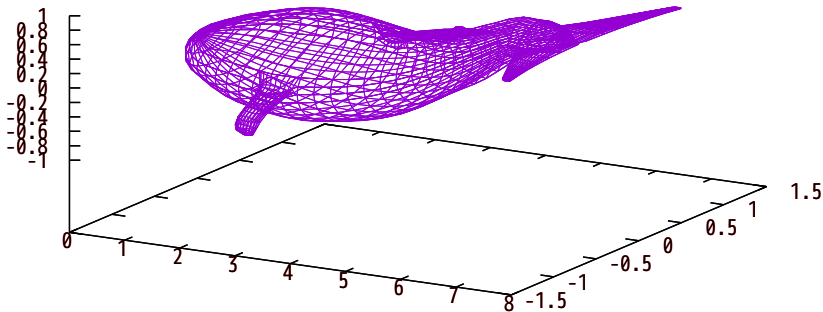



# Auto-labeling plots from text fields in datafile

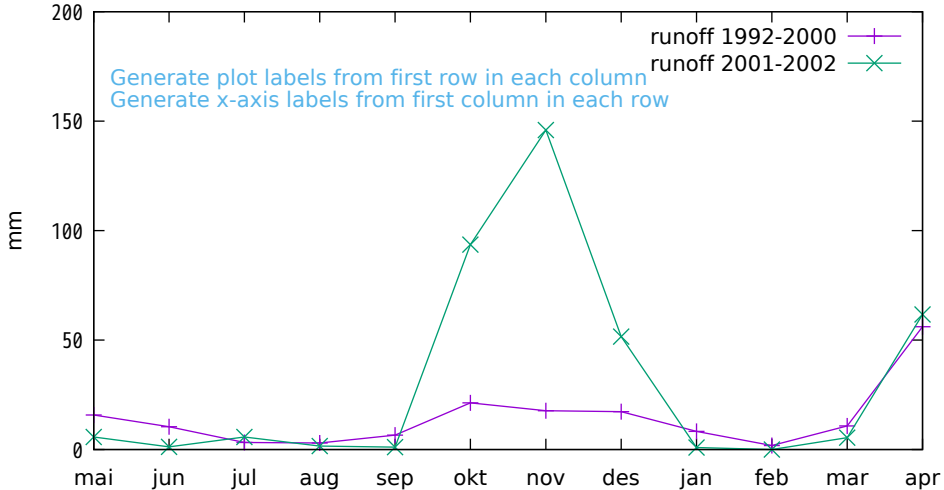

Read tic labels from a datafile column

An approximation of Hans Olav Eggstad's categoric plot patch using 'using (\$0):2:xticlabels(1)' and 'set style fill solid border -1'

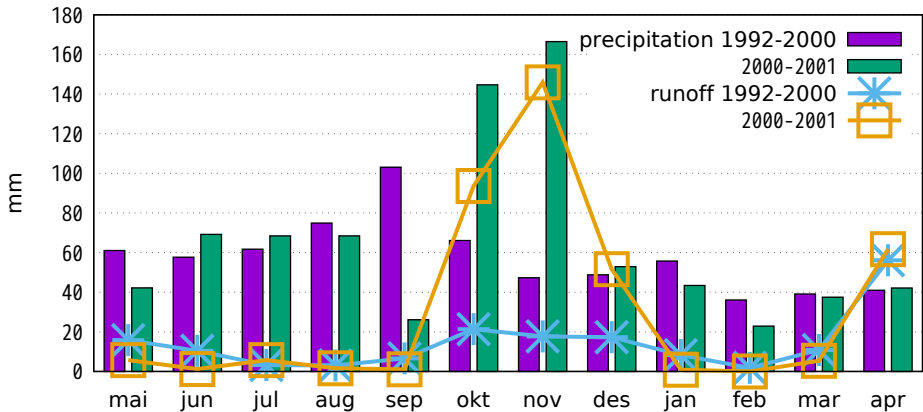

Same plot using x2ticlabels also

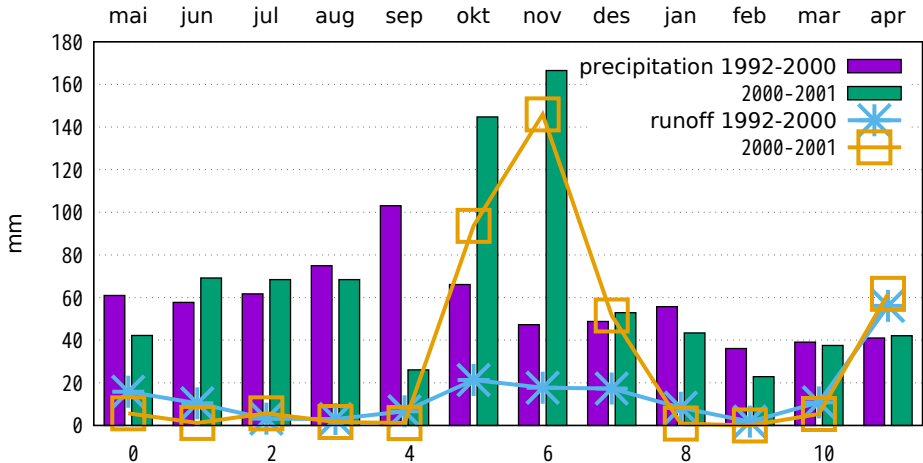

Plot from table format (titles taken from column headers)

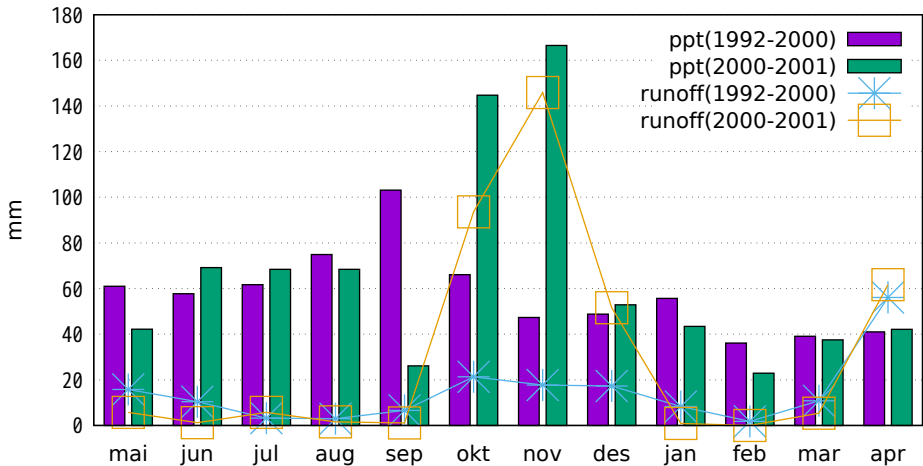

Plot actual y-value as a label

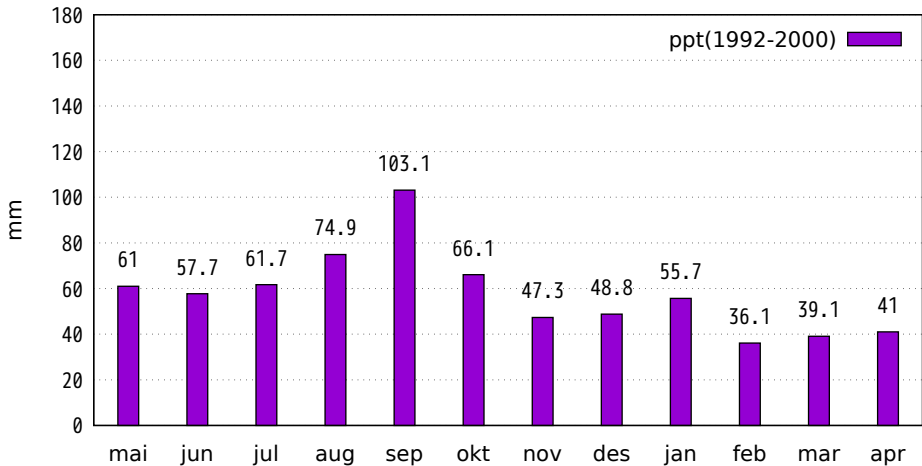

Plot using boxed labels

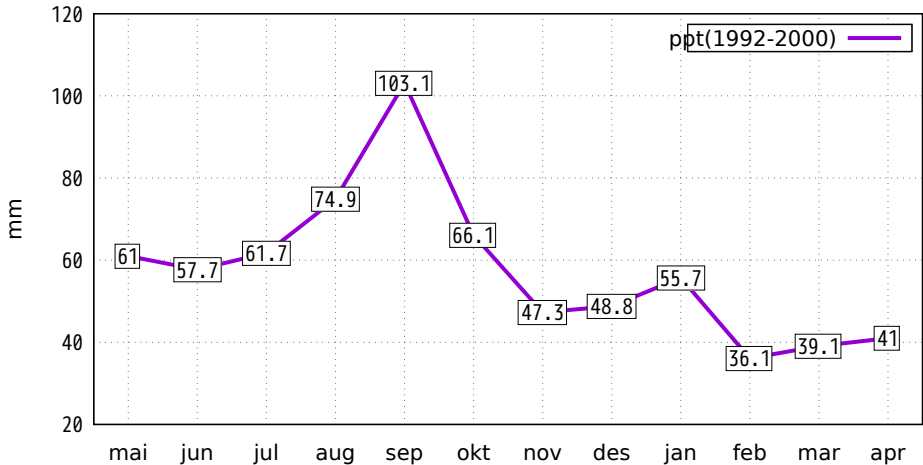

textboxes with blue border

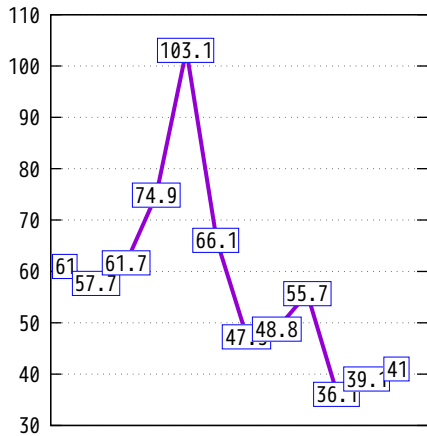

larger textboxes with grey fill

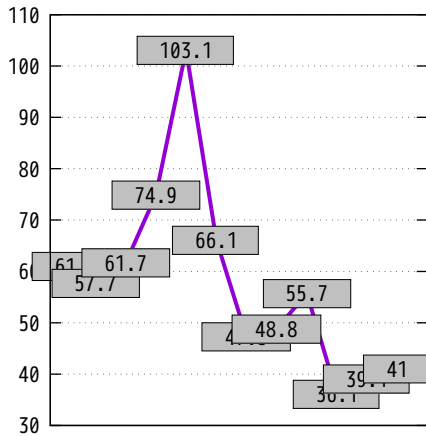

Hypertext is shown when the mouse is over a point

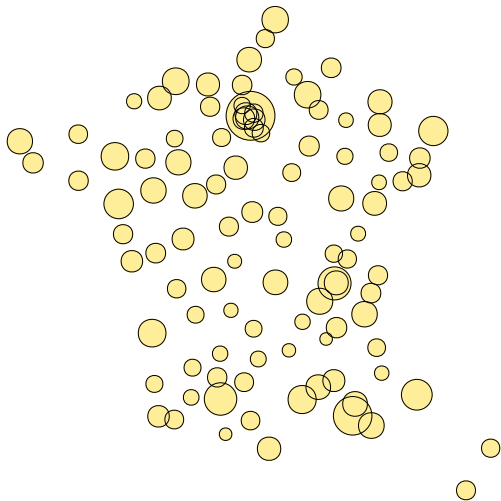



variable color and orientation in plotstyle 'with labels'

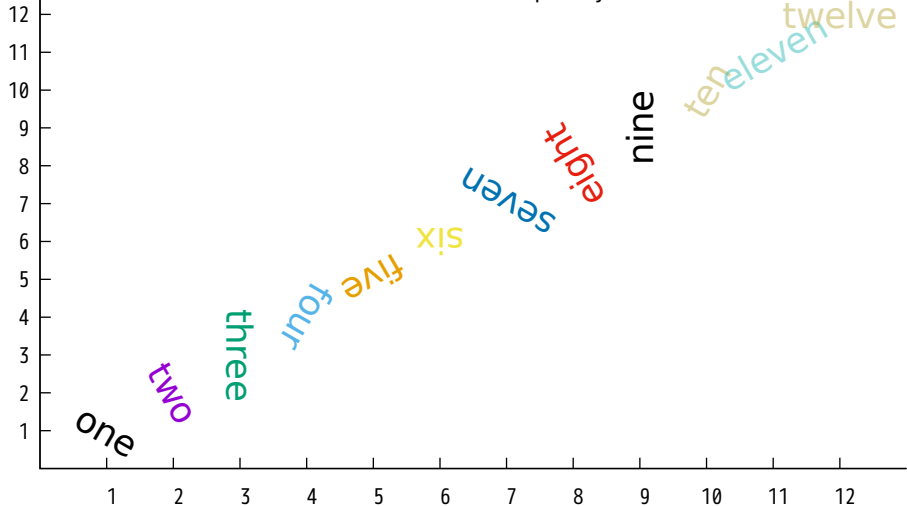

# Use of stats command to find min/max/mean before plotting

## One data column

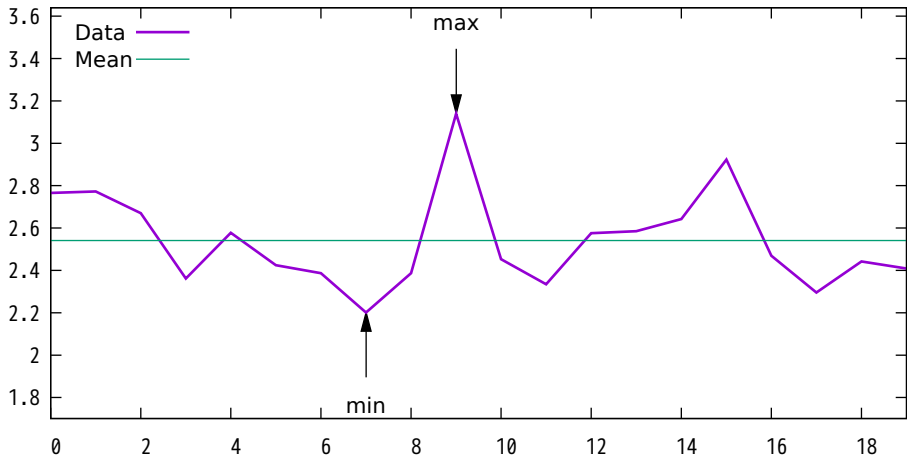

# Use of stats command to find min/max/mean before plotting

## Two data columns

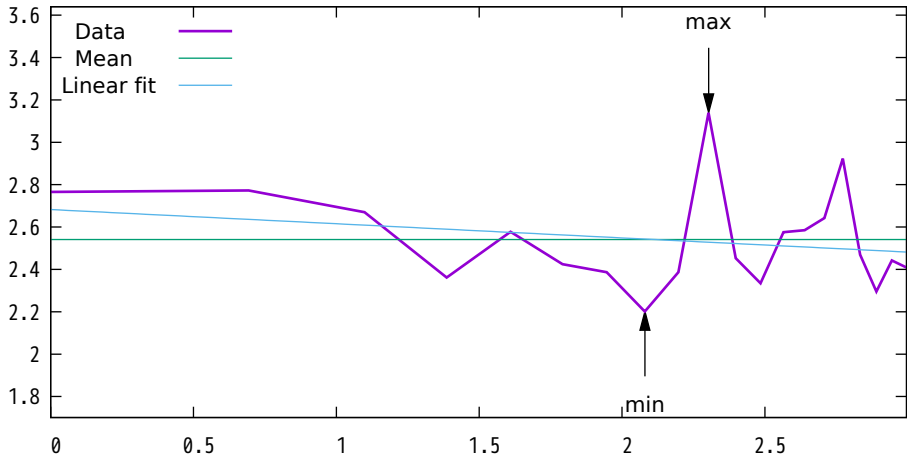

# Iteration within plot command

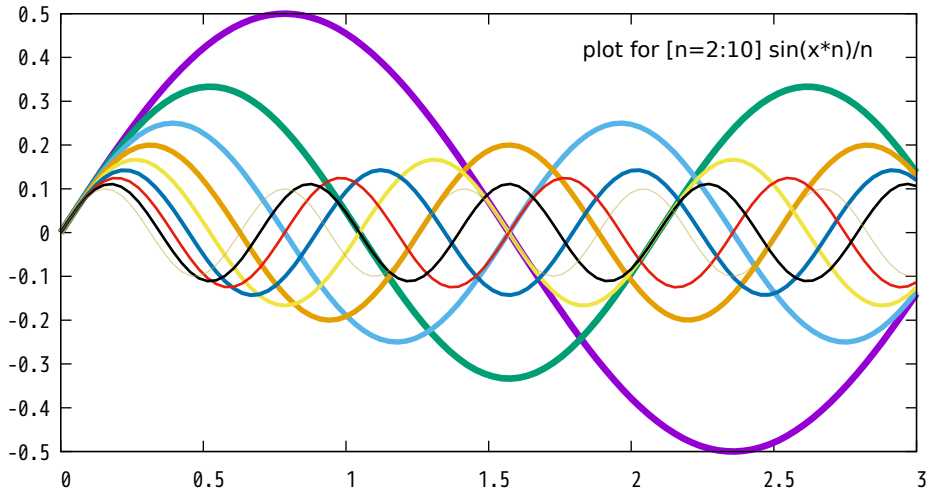

Iteration over all available data in a file

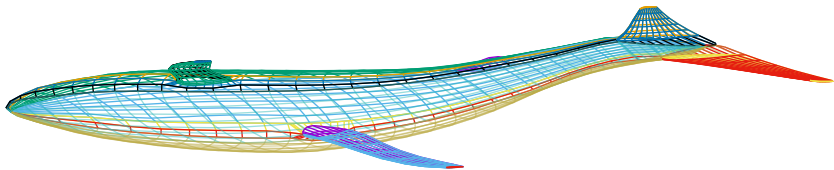

plot for [scan=1:\*] 'whale.dat' index scan

scan 1	—	scan 7	—	scan 13	—	scan 19	—
scan 2	—	scan 8	—	scan 14	—	scan 20	—
scan 3	—	scan 9	—	scan 15	—	scan 21	—
scan 4	—	scan 10	—	scan 16	—	scan 22	—
scan 5	—	scan 11	—	scan 17	—	scan 23	—
scan 6	—	scan 12	—	scan 18	—		

plot for [i=1:4] for [k=i:i] for [j=1:k] 10\*k + cos(j\*x)

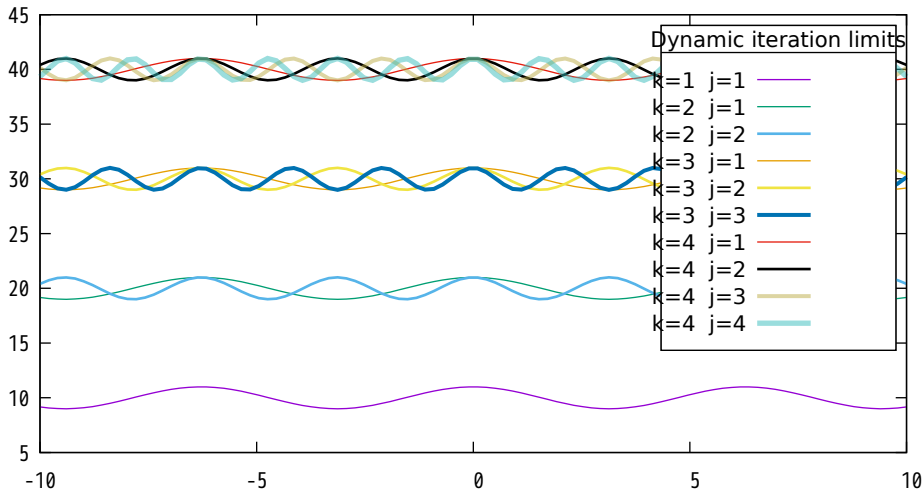



US immigration from Northern Europe  
Plot selected data columns as histogram of clustered boxes

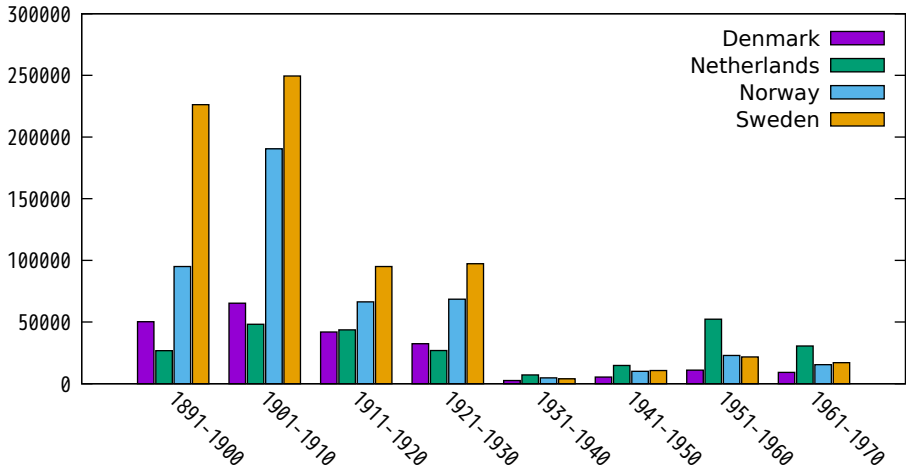



US immigration from Northern Europe  
(same plot with larger gap between clusters)

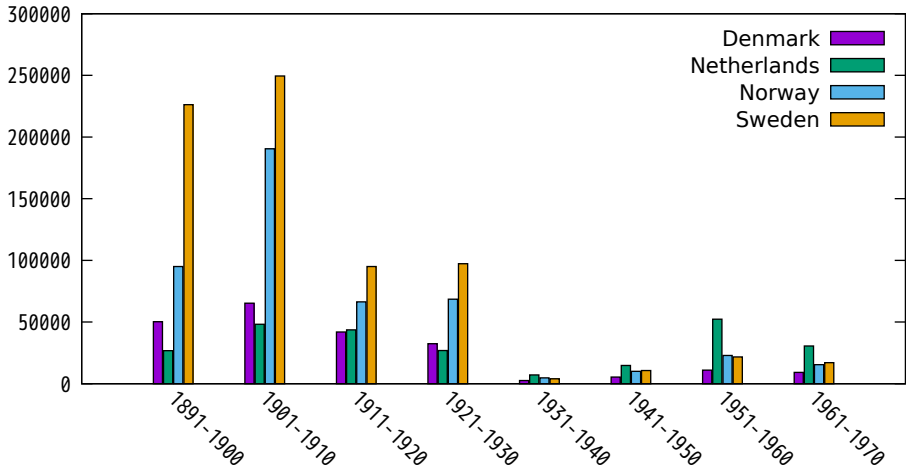

US immigration from Europe by decade  
 Plot as stacked histogram

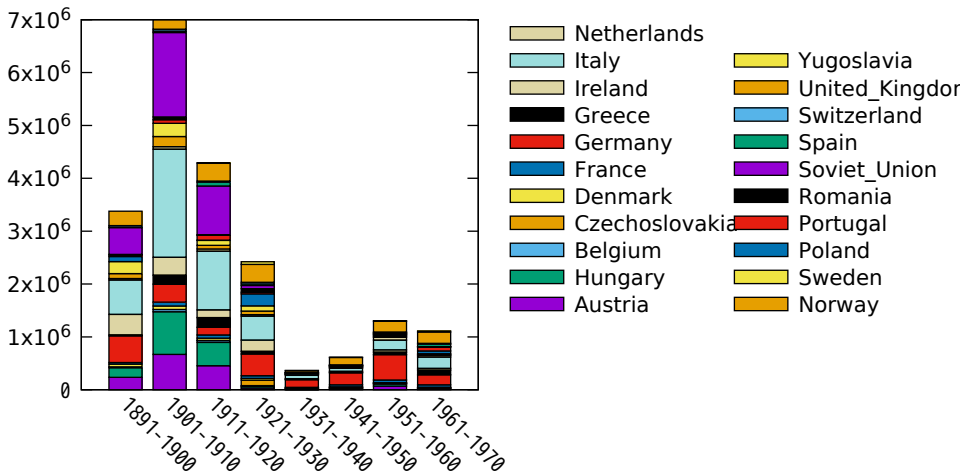

US immigration from Europe by decade  
 Fraction of total plotted as stacked histogram

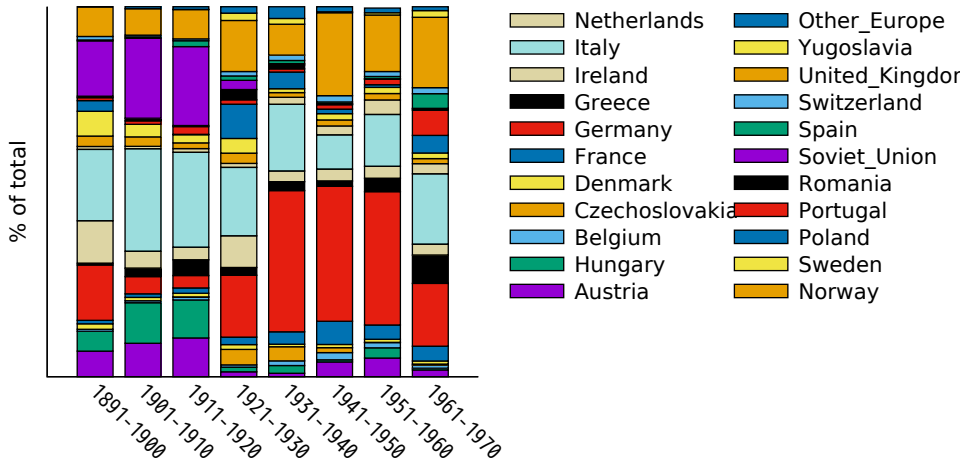

Immigration from Northern Europe  
(columnstacked histogram)

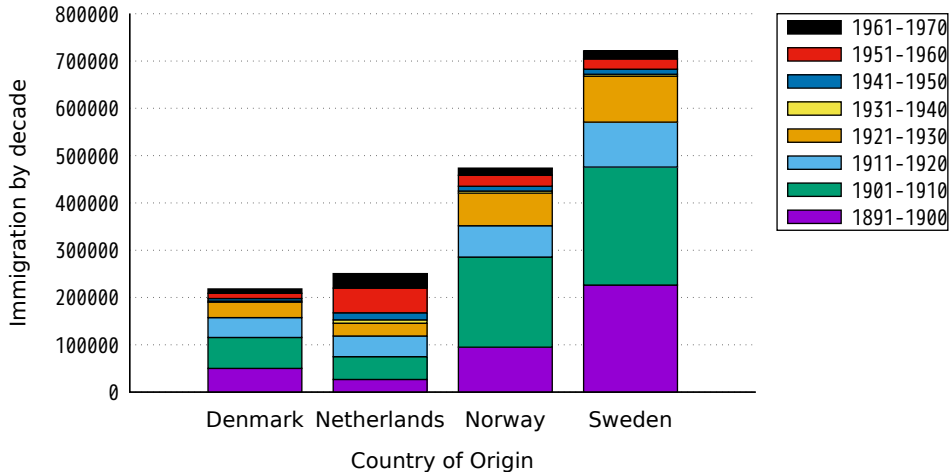

## Immigration from different regions (give each histogram a separate title)

Immigration by decade

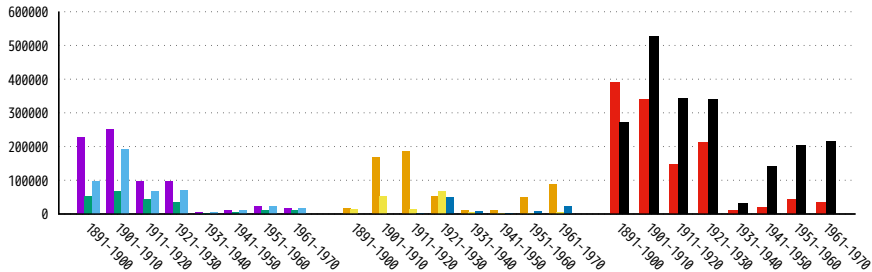

- (note: histogram titles have specified offset relative to X-axis label)
- |                 |                 |                |
|-----------------|-----------------|----------------|
| Northern Europe | Southern Europe | British Isles  |
| Sweden          | Greece          | Ireland        |
| Denmark         | Romania         | United_Kingdom |
| Norway          | Yugoslavia      |                |

Immigration from different regions  
(give each histogram a separate title)

Immigration by decade

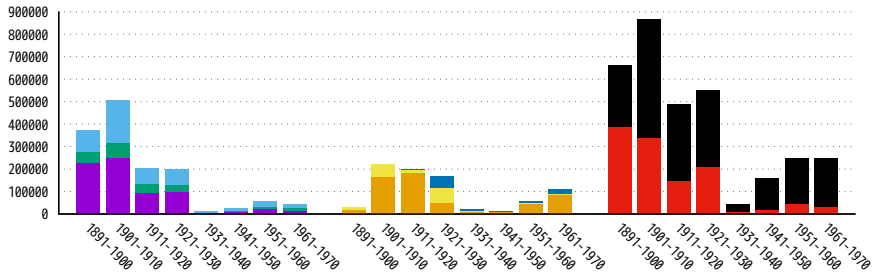

Northern Europe: Sweden, Denmark, Norway  
 Southern Europe: Greece, Romania, Yugoslavia  
 British Isles: Ireland, United\_Kingdom

(Same plot using rowstacked rather than clustered histogram)

## Default Histogram Colouring

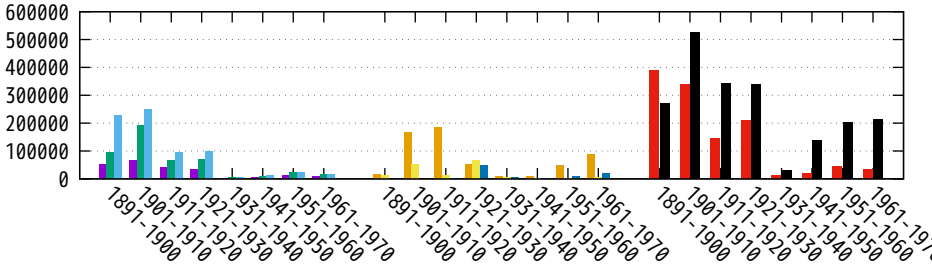

Immigration from different regions

Northern Europe

Southern Europe

British Isles

- |         |            |                |
|---------|------------|----------------|
| Sweden  | Yugoslavia |                |
| Norway  | Romania    | United_Kingdom |
| Denmark | Greece     | Ireland        |

## Explicit start color in 'newhistogram' command

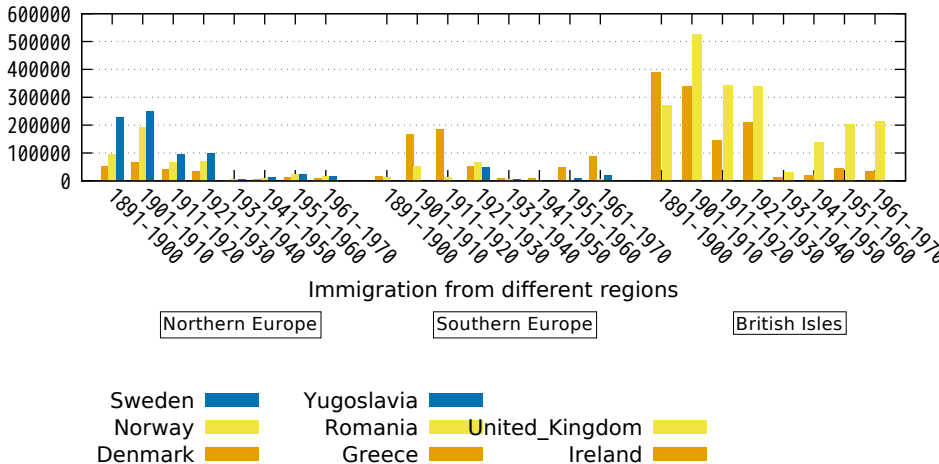



## Explicit start pattern in 'newhistogram' command

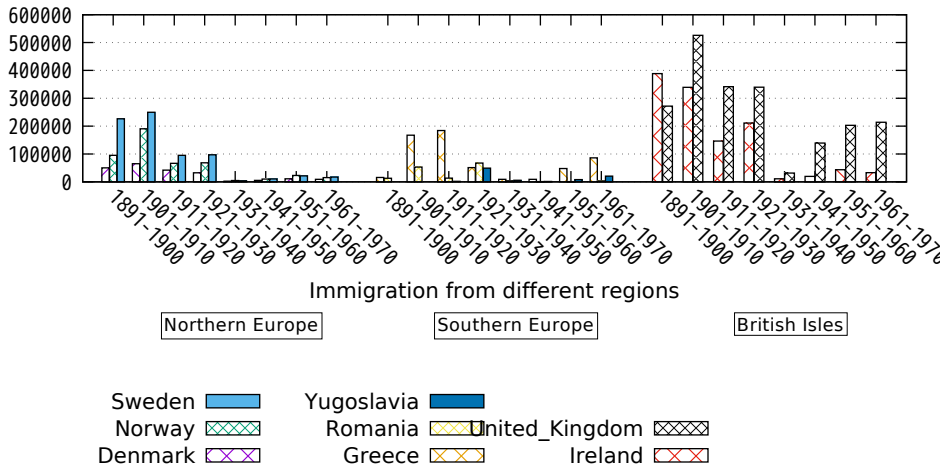

## Explicit start pattern and linetype

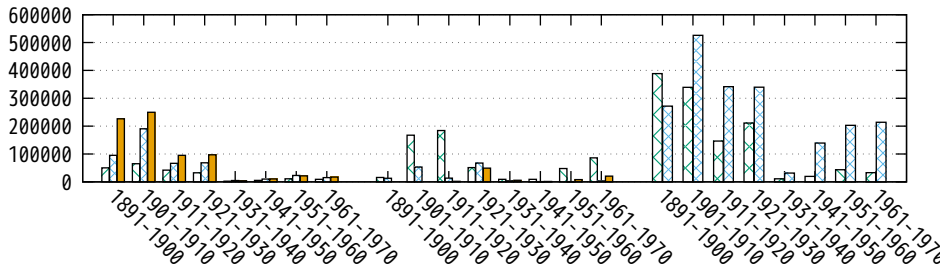

## Immigration from different regions

Northern Europe

Southern Europe

British Isles

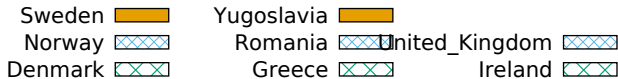

Place data values as labels in stacked histogram

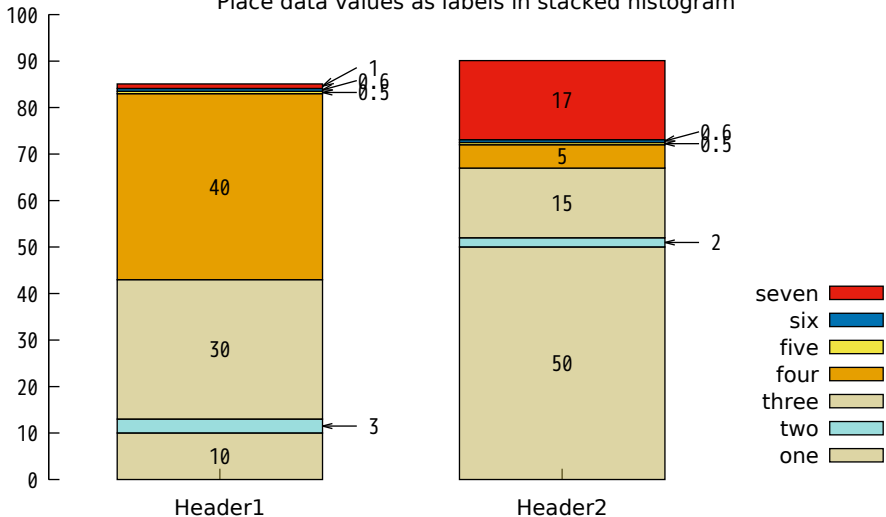



Fit function to values stored in an array

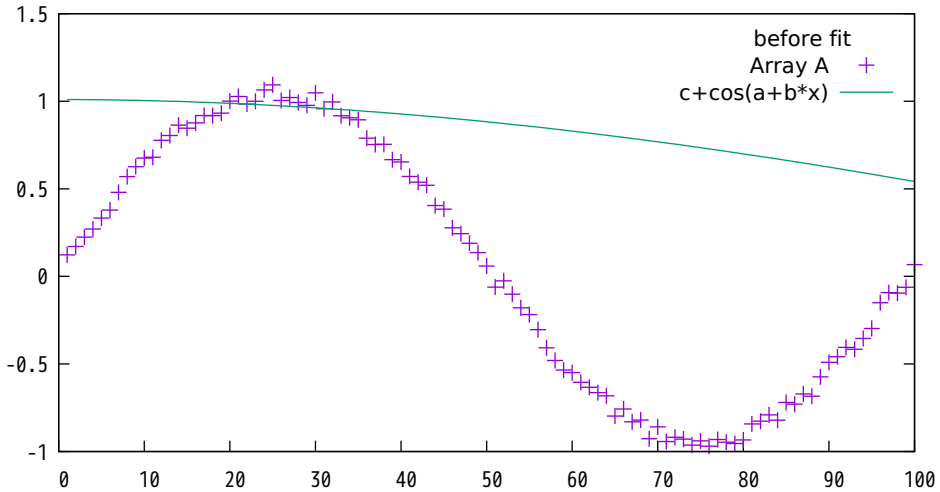

Fit function to values stored in an array

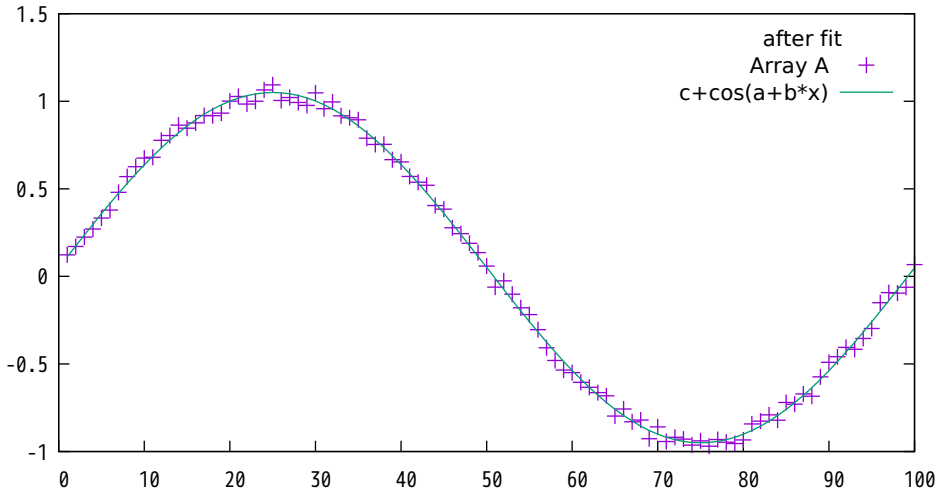

Illustrate loading an array from a column in a data file  
Note that first data point in the file is 'line 0'  
but it goes into array element Data[1]

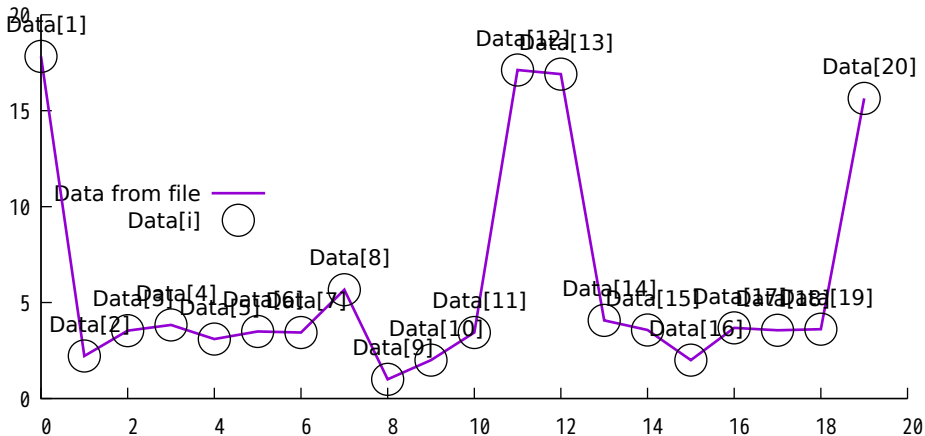

Larry Ewing's GIMP penguin on vacation basking in the balmy waters off the coast of Murmansk

'blutux.rgb' binary array=(128,128) flipy format='%uchar'  
"I flew here... by plane. Why? For the halibut."

140

120

100

80

60

40

20

0

0

20

40

60

80

100

120





# Translations of position variables via 'using'

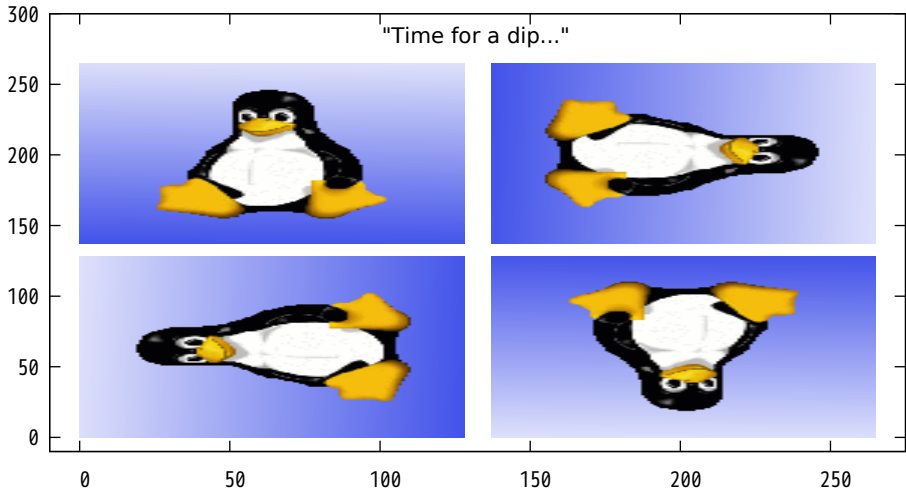

Palette mode 'image' used to produce psychedelic bird

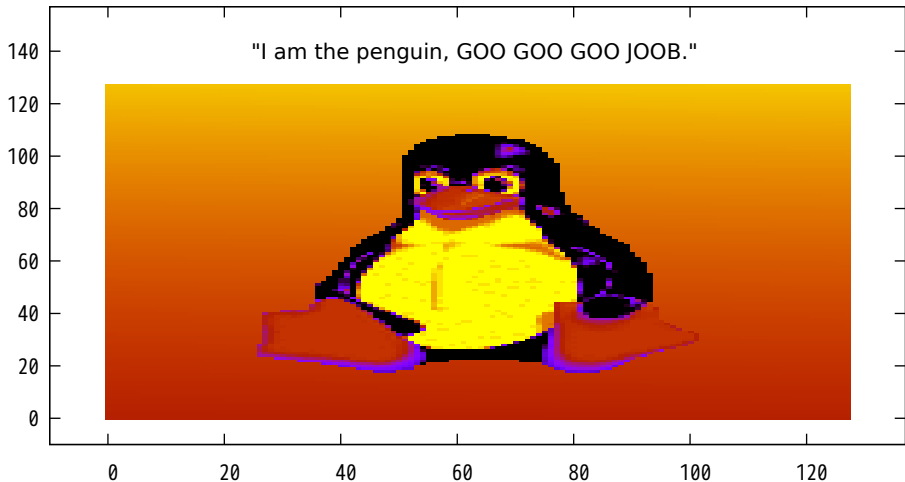

The palette can be changed from color to gray scale

"This picture was taken by my friend Ansel Adams."

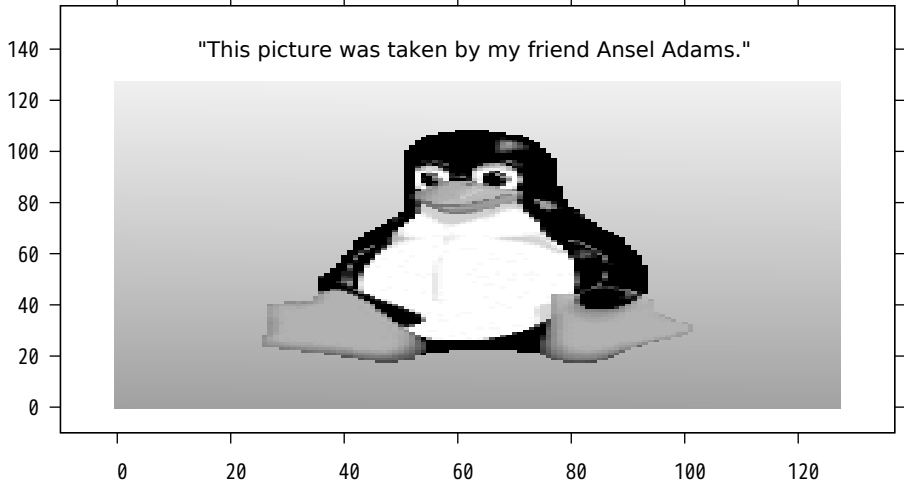

As with 3d color surfaces, a color box may be added to the plot

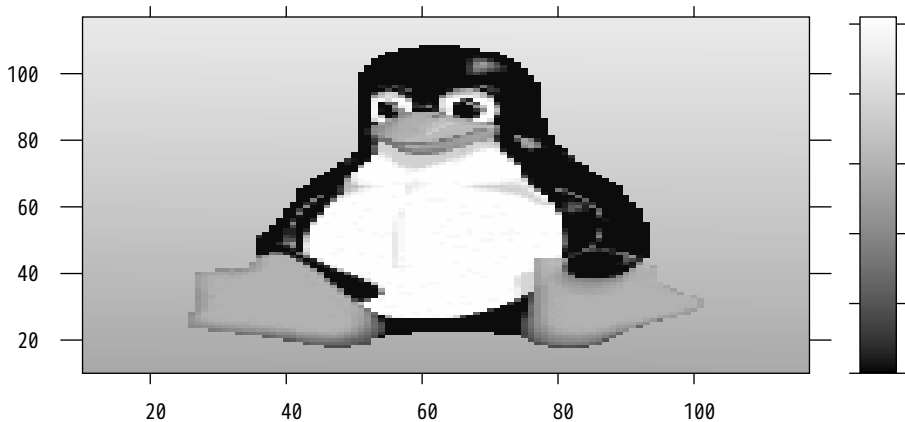

Polygons used to draw pixels for rotated images  
Notice the slower refresh rate than for the next plot

flipy rotation=45d center=(63.5,63.5) format='%uchar' using (\$1+\$2+\$3)/3

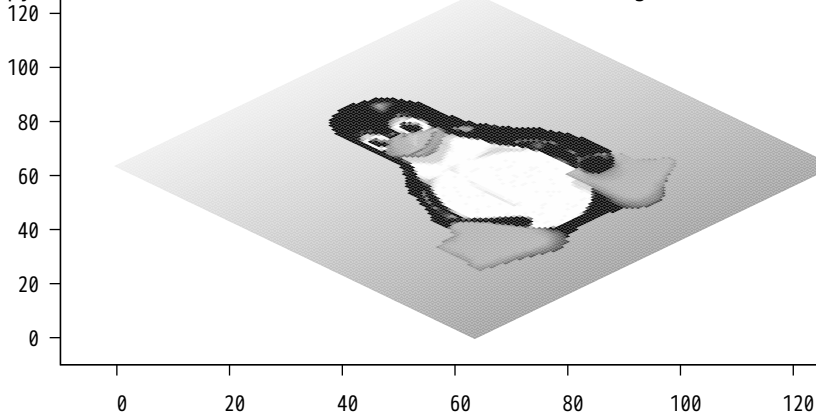

Terminal image routine used to draw plot rotated about origin  
Notice the faster refresh rate than for the previous plot

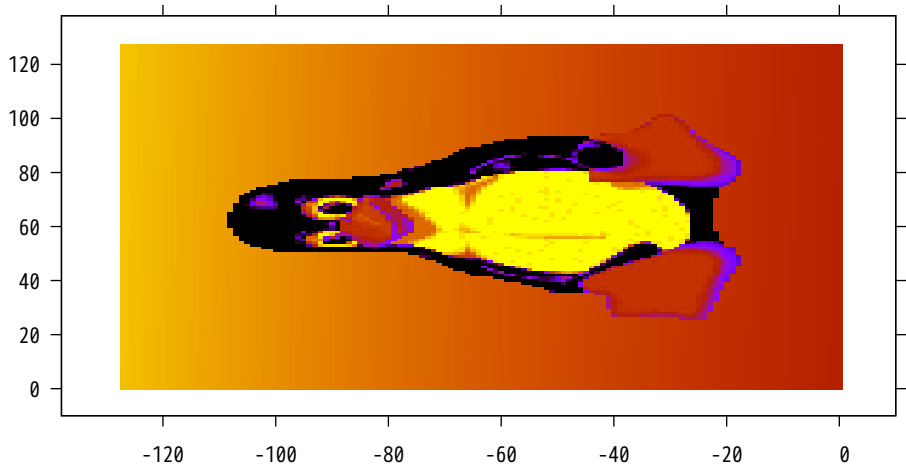

"I do impersonations..." Selection of the input channels via `using` "A cardinal."

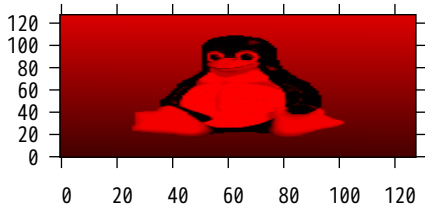
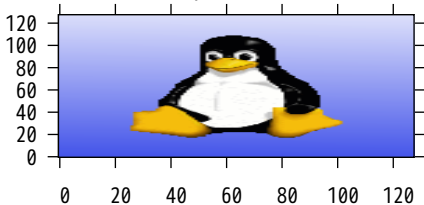

"A parrot."

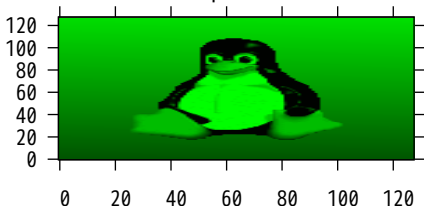

"A bluebird."

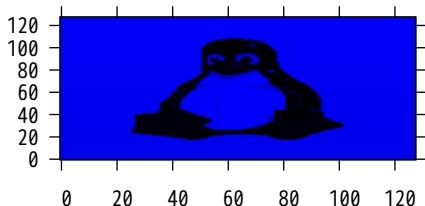

Lake Mendota, "or Wonk-sheck-ho-mik-la!"

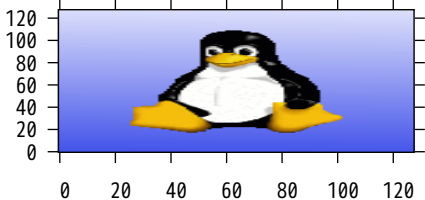

Adjust color balance in the using spec "Lucky I brought sunscreen."

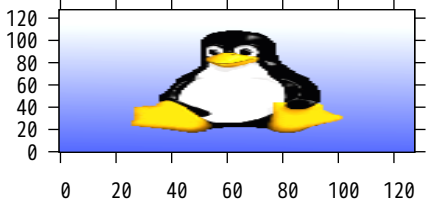

Sunset on the Terrace

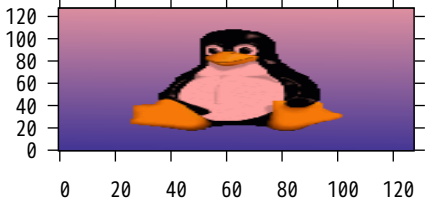

Sultry evening

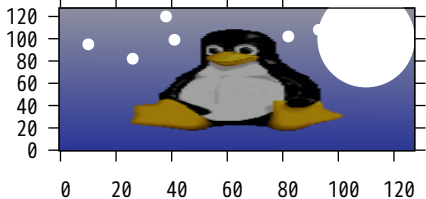



Convex November 1-7 1989 Circadian

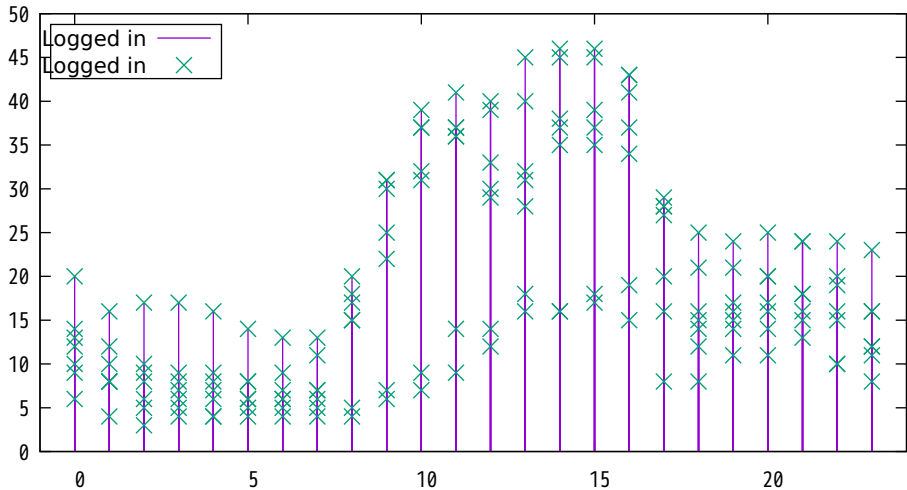

# Convex November 1-7 1989

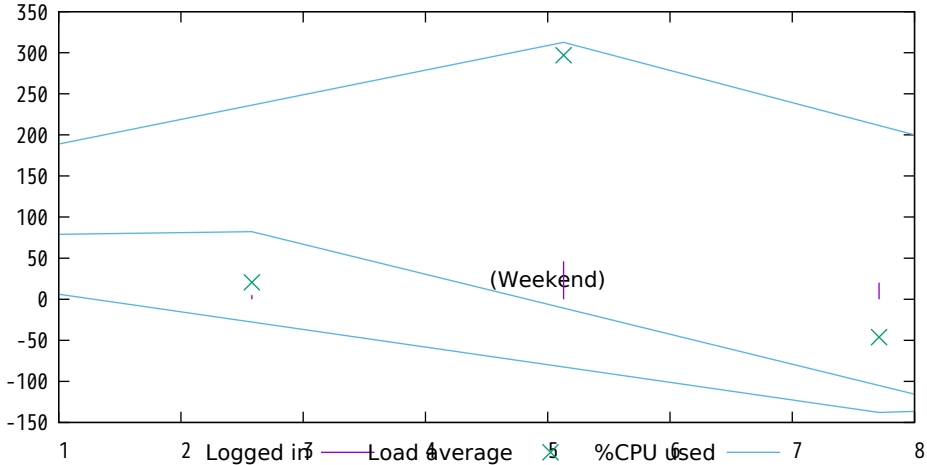

2d binary data example where record length is part of command

'scatter2.bin' binary endian=little record=30:30:29:26 using 1:2:3 +

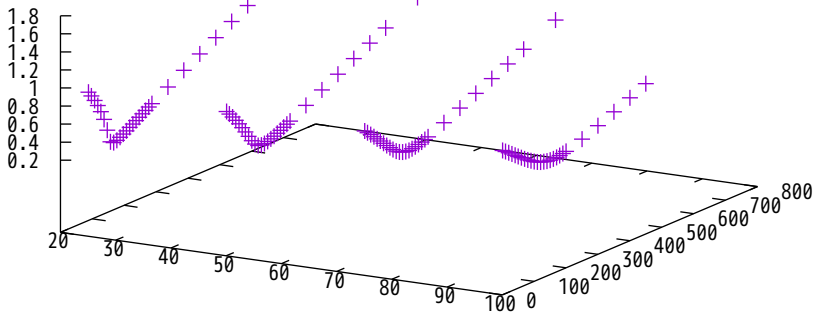

If plots in columns match, your compiler is little endian

Little endian

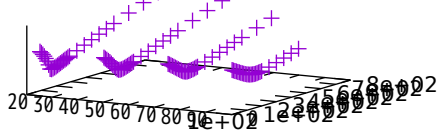

Big endian

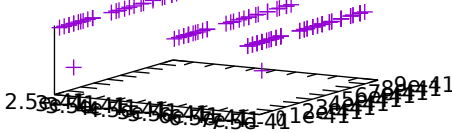

Default

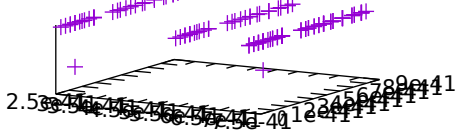

Swapped

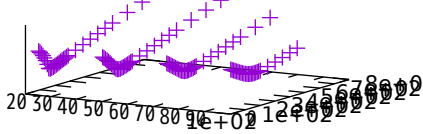

Close up of pixels having grid points  $(0,0)$ ,  $(0,2)$ ,  $(2,0)$  and  $(2,2)$

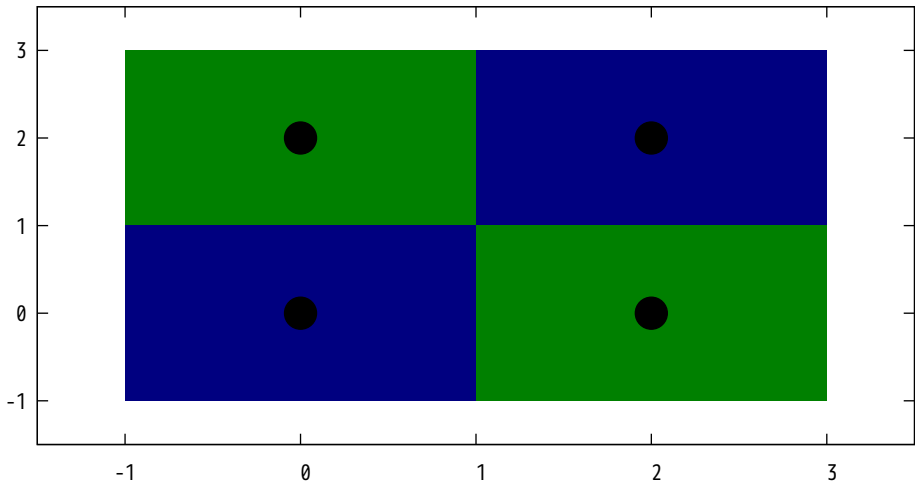

Simple extension of a two dimensional image into three dimensions

`y array=(128,128) flip=y format='%uchar%uchar%uchar' using ($1+$2+$3)/3`

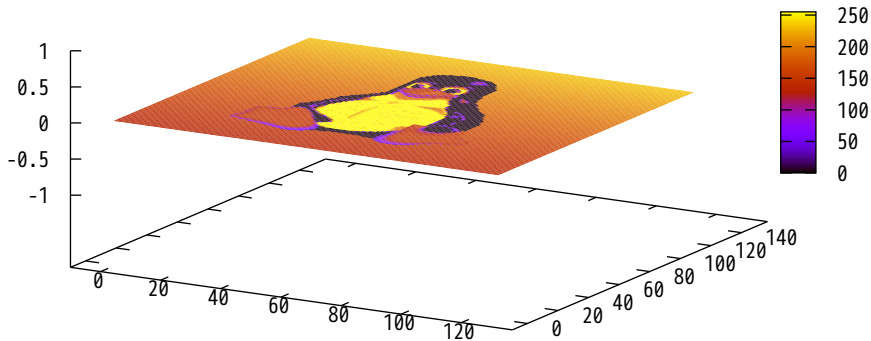

Orientation operations from 'plot' also apply to 'splot'

0d center = (63.5,63.5,50) format='%uchar%uchar%uchar' using (\$1+\$2+\$3)

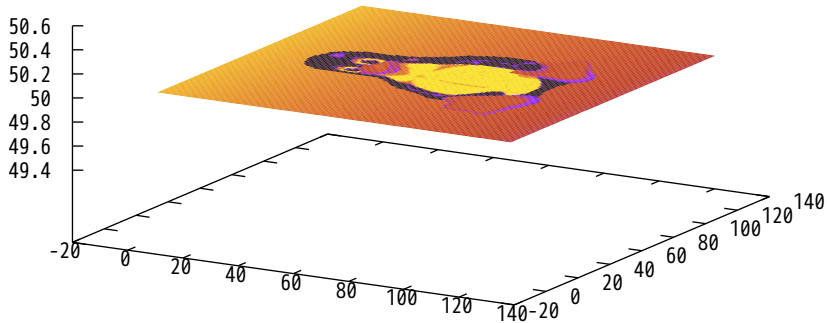

The key word 'perpendicular' applies only to 'plot'

3.5,63.5,50) perp=(1,1,1) format='%uchar%uchar%uchar' using (\$1+\$2+\$3)/3

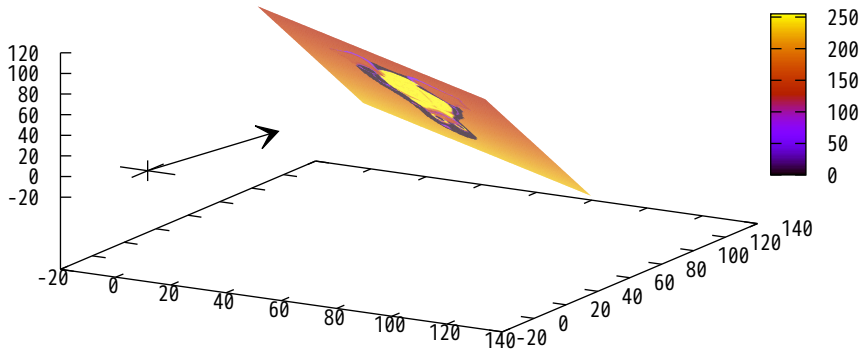



Temporal data having one generated coordinate

Along the x-axis

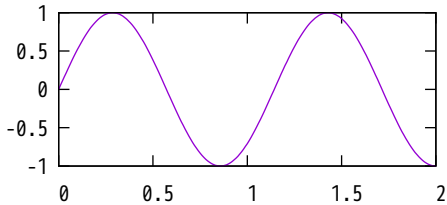

Along the y-axis

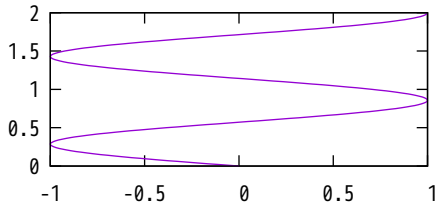

Along a 225 degree projection

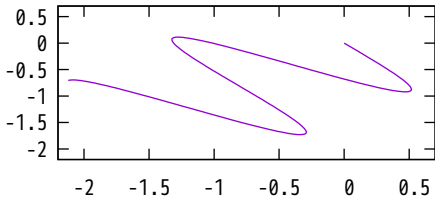

2d binary data example where x coordinate is ignored then generated

0:29:26 origin=(25,0,0):(50,0,0):(75,0,0):(100,0,0) format='%f%f' using (0):2:3 +

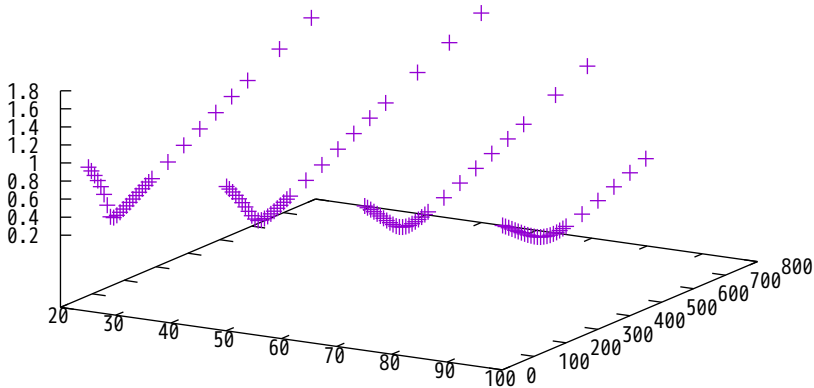

The key word 'skip' used to ignore some data

rd=30:26 skip=360:348 origin=(50,0,0):(100,0,0) format='%f%f' using (0):2:3 +

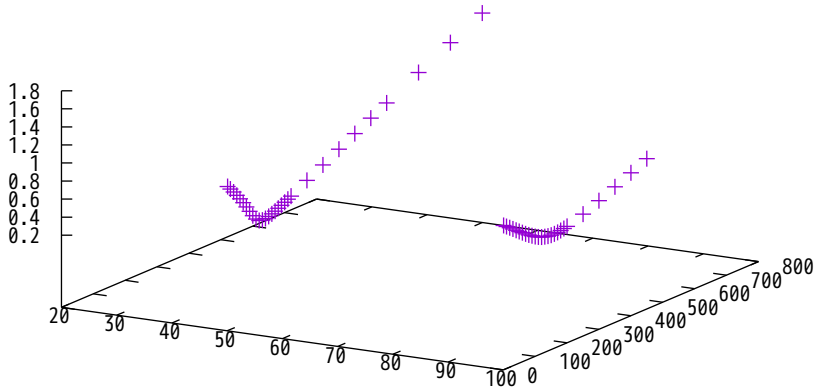

# Uniform sampling in the polar coordinate system

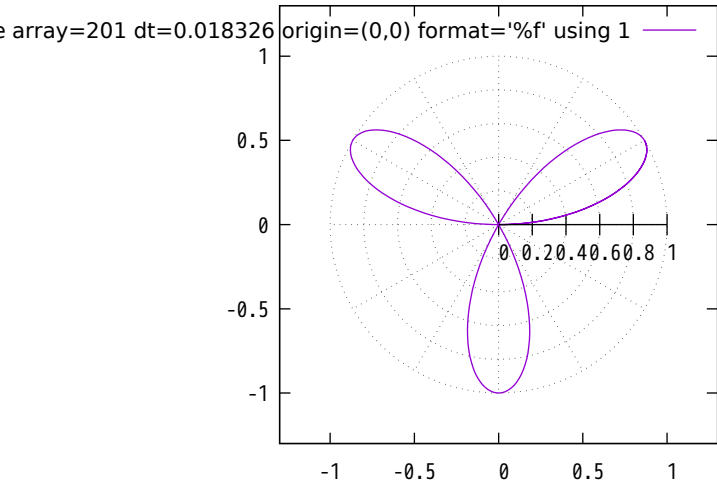

# Matrix binary data (gnuplot binary) translated

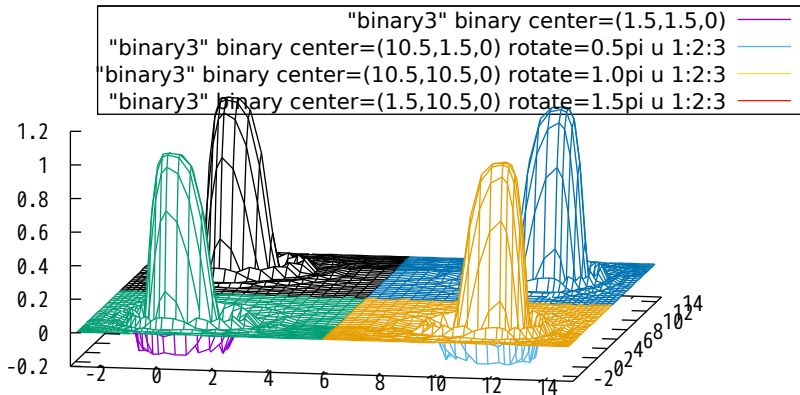

# Non-decimated matrix data file

"binary2" binary 

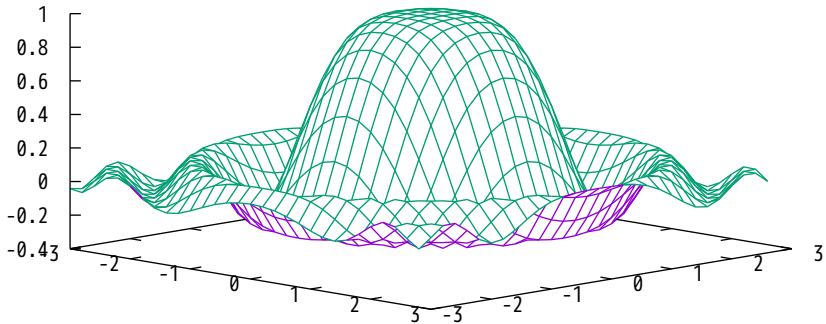

Decimate by two in first dimension

"binary2" binary every 2 

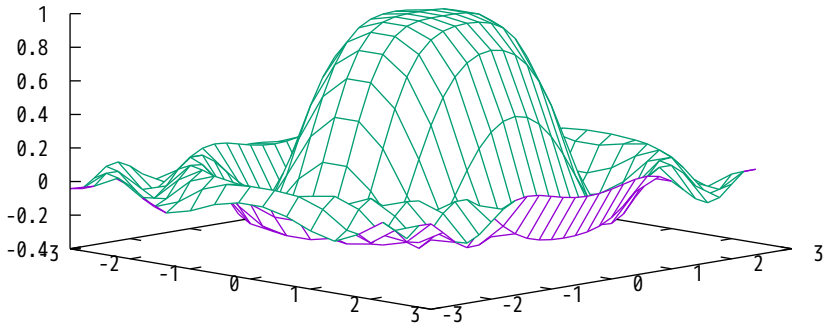

Decimate by three in second dimension

"binary2" binary every :3

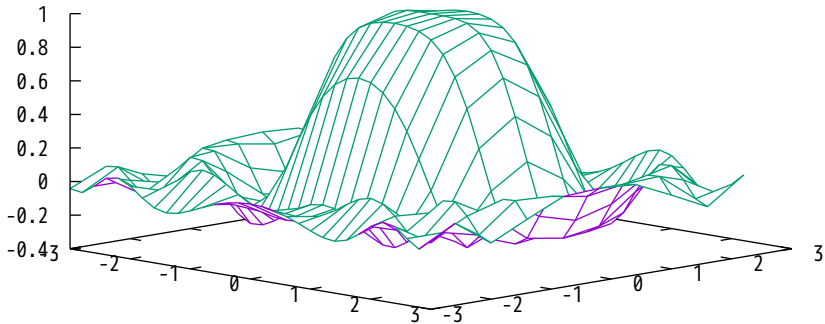



Decimate by four in both dimensions

"binary2" binary every 4:4

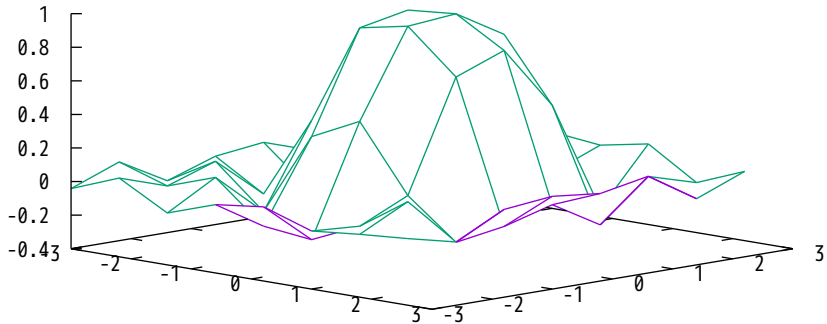

Decimation works on general binary data files as well.  
Let Tux have his fun...

```
utux.rgb' binary array=(128,128) flipy format='%uchar' every 1:1:43:15:83:65
```

"Can I do that?"

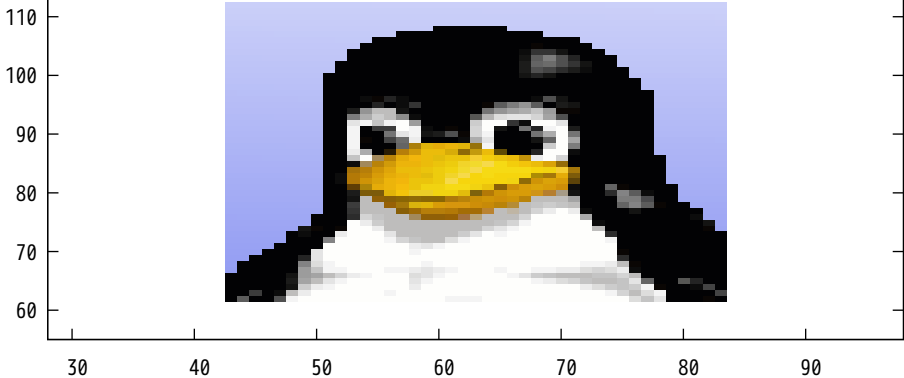

... Sure, go ahead.

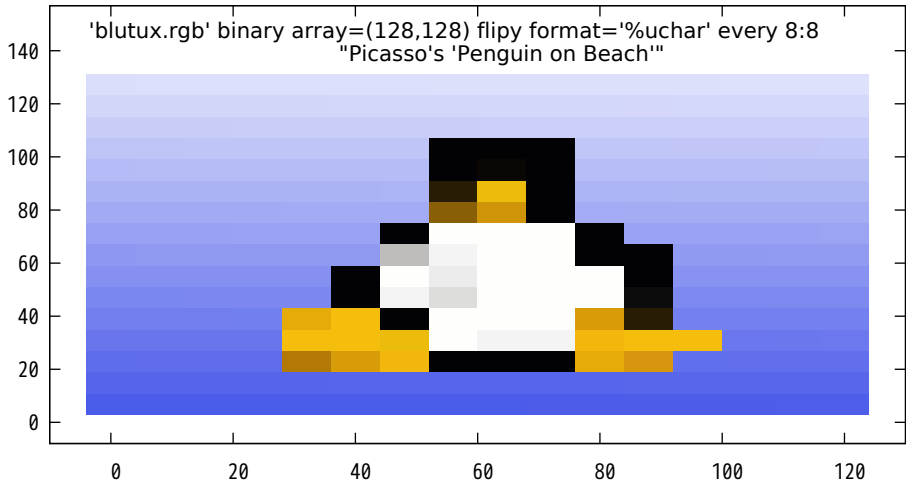

# Automatically recognizing file type and extracting file information

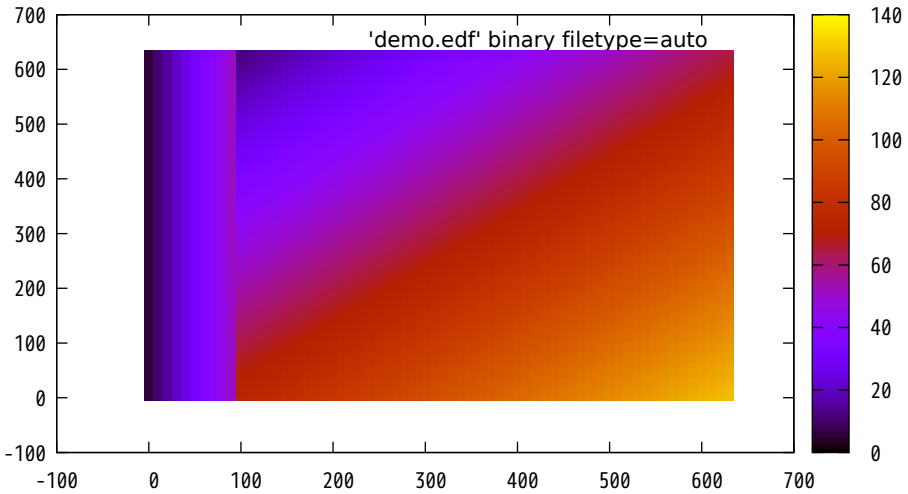

Details read from file

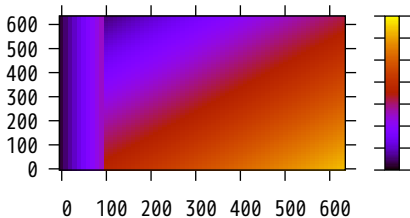

Transpose of file-read axes parameters

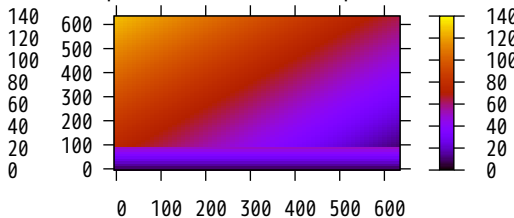

Details specified at command line

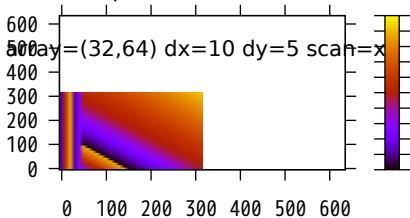

Transpose of command line axes parameters

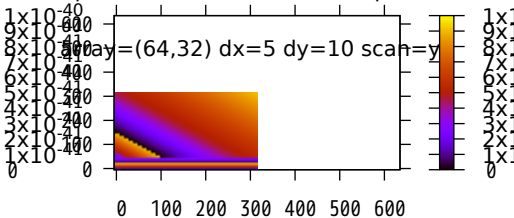

Binary data specified at the command line, intended for use through pipe

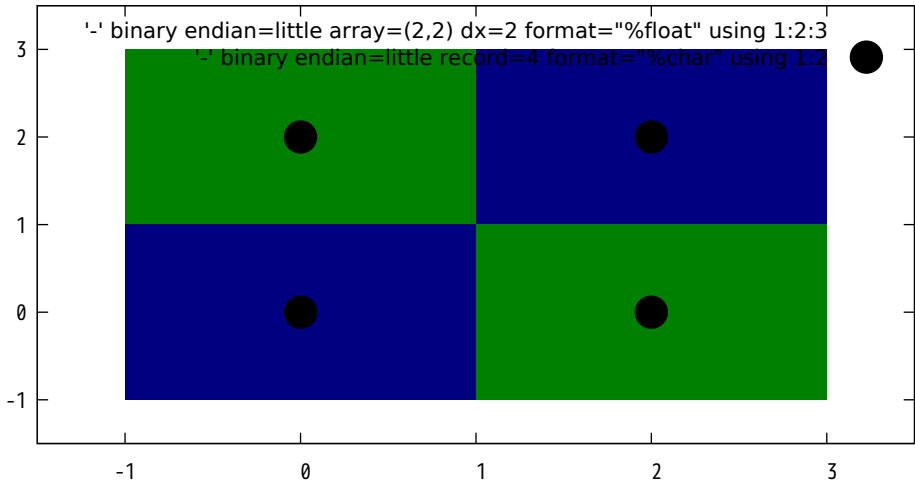

'asciimat.dat' matrix index 0

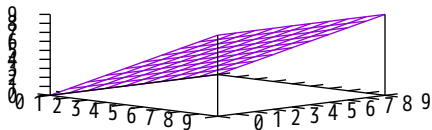

'asciimat.dat' matrix index 1

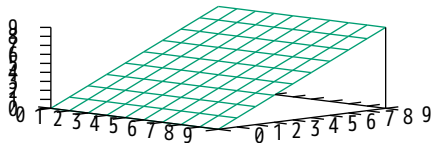

'asciimat.dat' matrix index 2

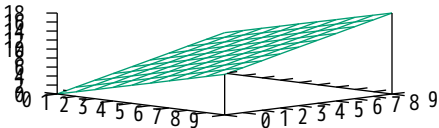

'asciimat.dat' matrix index 2 using 1:(2\*\$2):(\$3\*

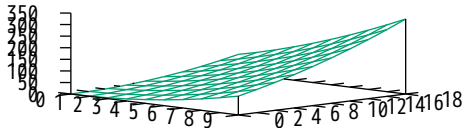

Images reverse according to axis orientation

"Eccentric coordinate systems"

"Cartesian plane!"

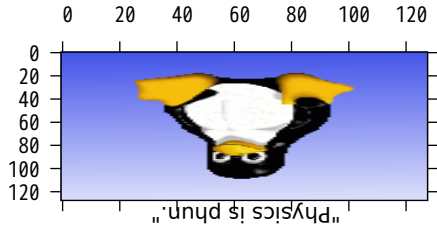
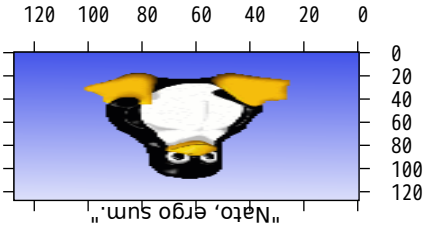
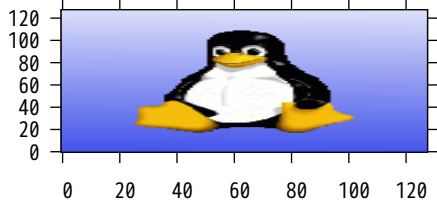
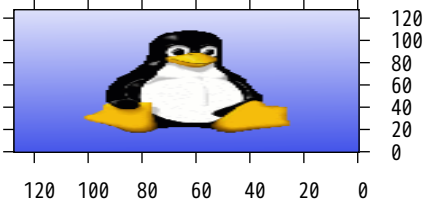



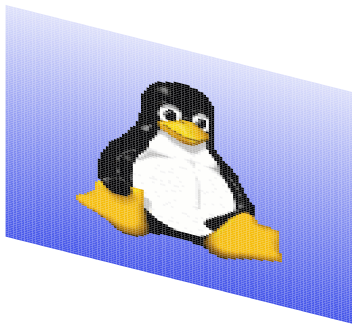
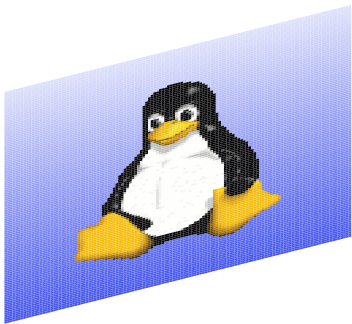

Tux in a reflective mood

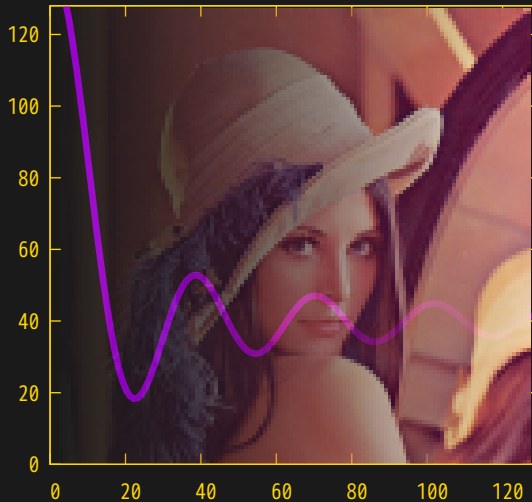

Plot style rgbalpha  
solid line █  
Lena with linear  
alpha gradient

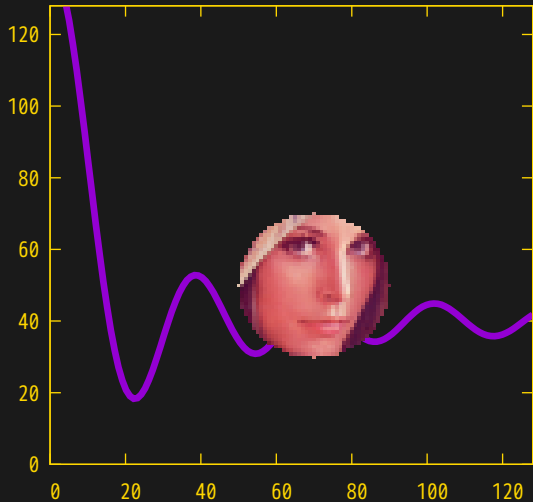

Plot style rgbalpha

solid line



Lena with circular mas

# Treatment of missing/undefined/NaN/Inf data

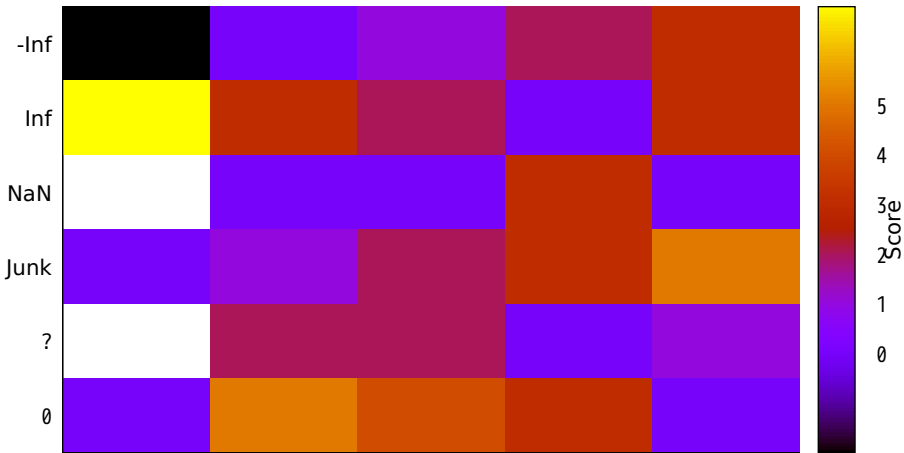

First column contains various odd values

Same thing in 'pixels' mode (2D)

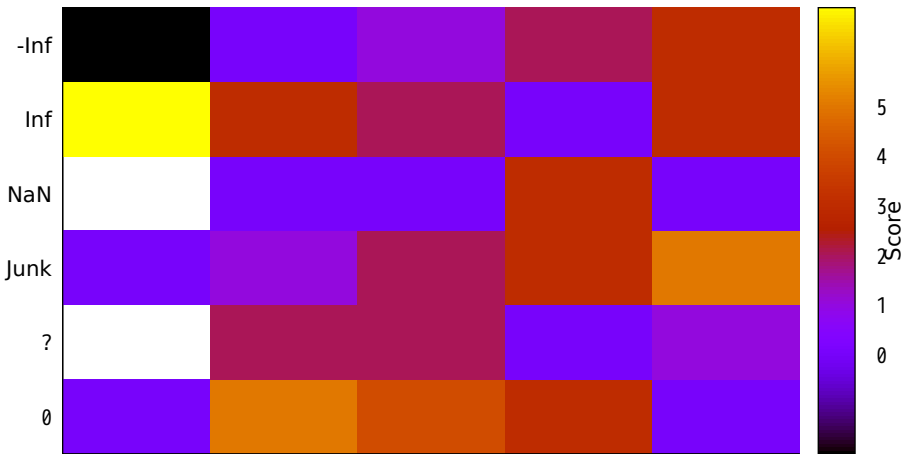

First column contains various odd values

Same thing passing data value through 'using 1:2:( $\$3$ )'

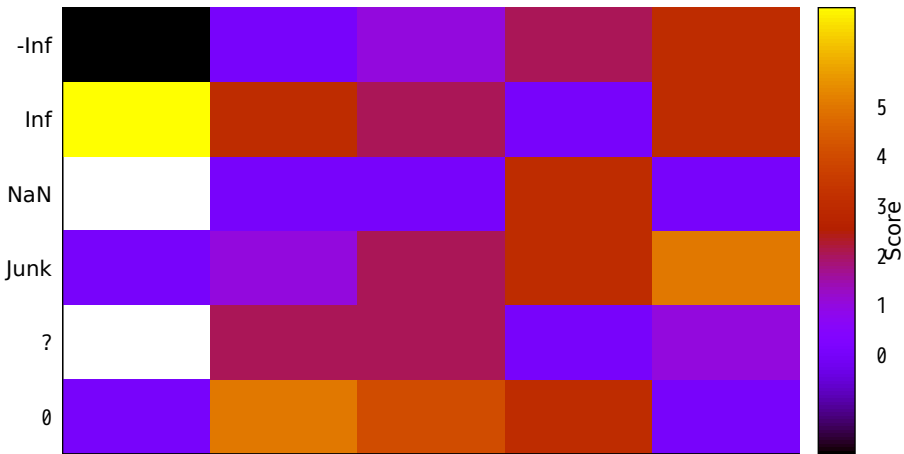

First column contains various odd values

### Same thing in 3D mode

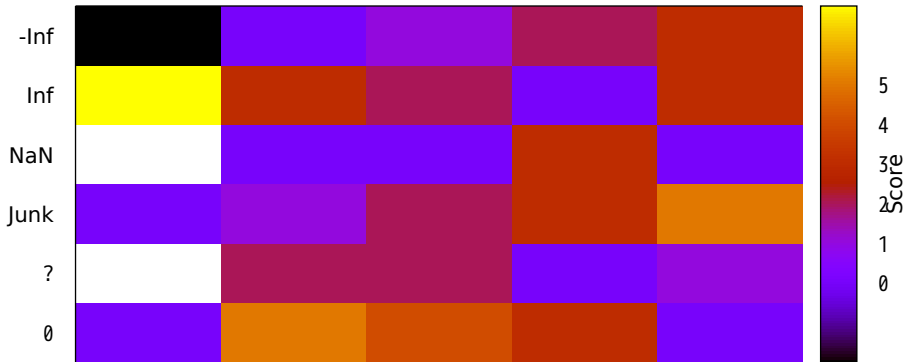

First column contains various odd values

### Same thing in 'pixels' mode (3D)

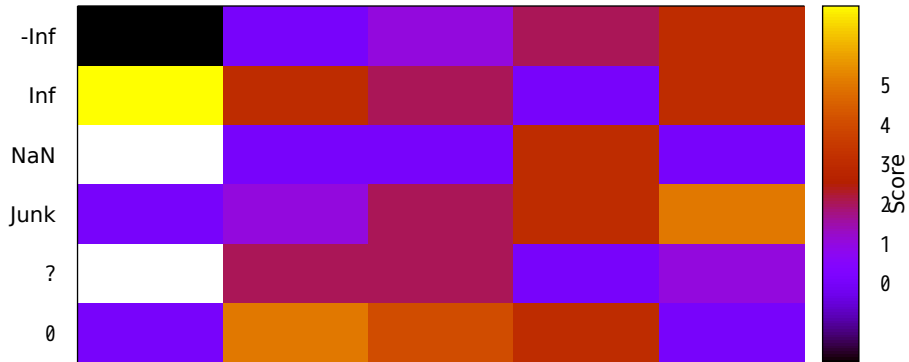

First column contains various odd values



3D image with pixel value in 4th column

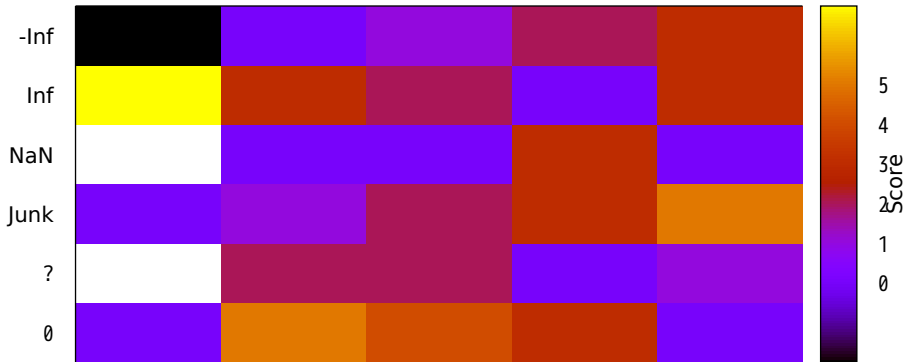

First column contains various odd values

image from non-matrix data

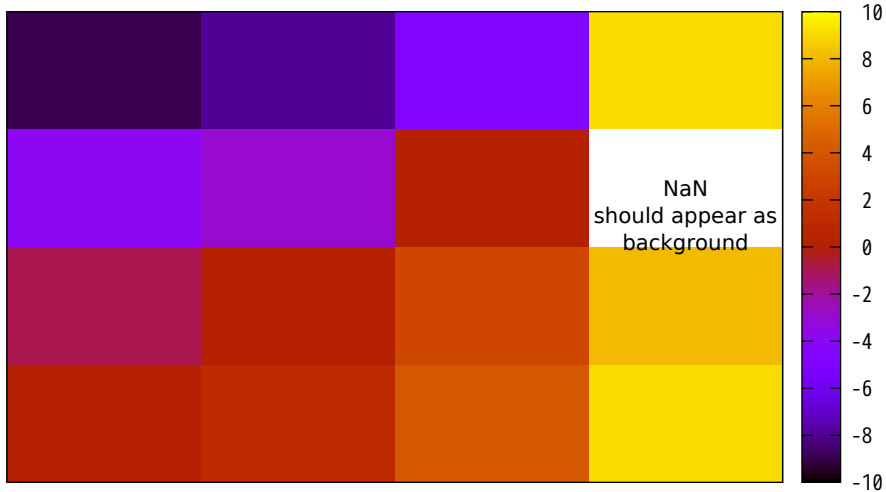

negative values mapped to log-scale colorbar

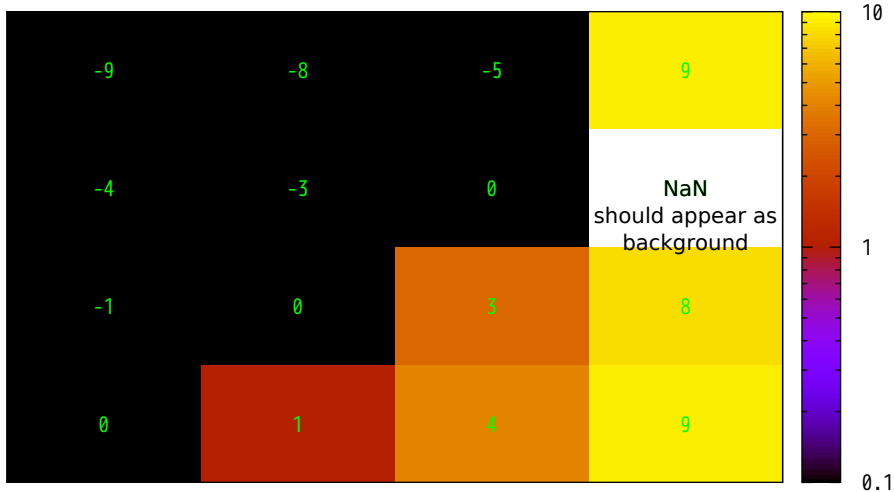

# Building Code Height Limits

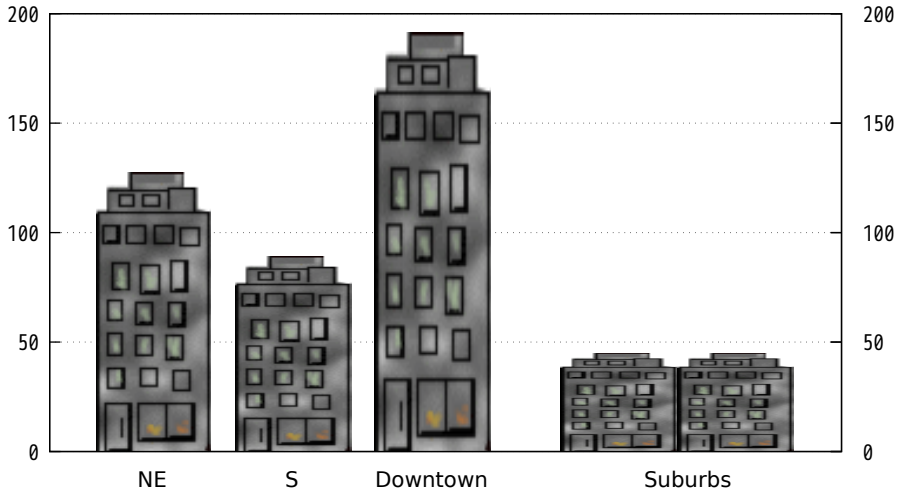

## Exercise substring handling

beg = 2 end = 4

foo = ABCDEF

foo[3:5] = CDE

foo[1:1] = A

foo[5:3] =

foo[beg:end] = BCD

foo[end:beg] =

foo[5:] = EF

foo[5:\*] = EF

foo[:] = ABCDEF

foo[\*:\*] = ABCDEF

foo.foo[2:2] = ABCDEFB

(foo.foo)[2:2] = B

foo[1:1] eq 'A' foo[2:2] ne 'X' = true

## Exercise string handling functions

```
foo      = ABCDEF  
strlen(foo) = 6  
substr(foo,3,4) = CD
```

```
haystack = `date`  
haystack = Fri Sep 7 16:00:34 JST 2018  
needle   = :  
S = strstr(haystack,needle) = 14  
haystack[S-2:S+2] = 16:00  
It is now 16:00
```

```
words(haystack) = 6  
word(haystack,5) = JST
```

sprintf output of long strings works OK

## Exercise word and words functions

foo = word and words can handle 'quoted string'

words(foo) = 6

word(foo, 6) = quoted string

foo = "double quotes" or 'single quotes'

words(foo) = 3

foo = Apostrophes inside words don't matter

word(foo, 4) = don't

# String-valued expression in using spec

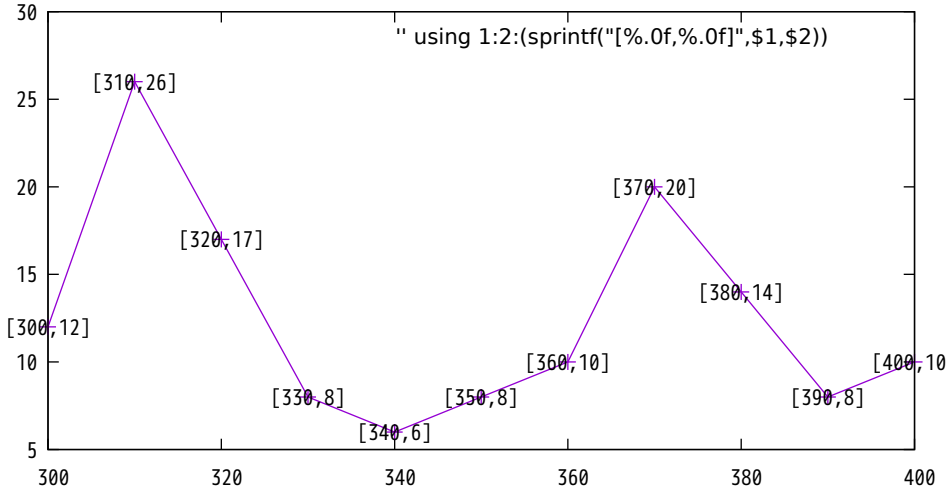



Constant string expressions as plot symbols

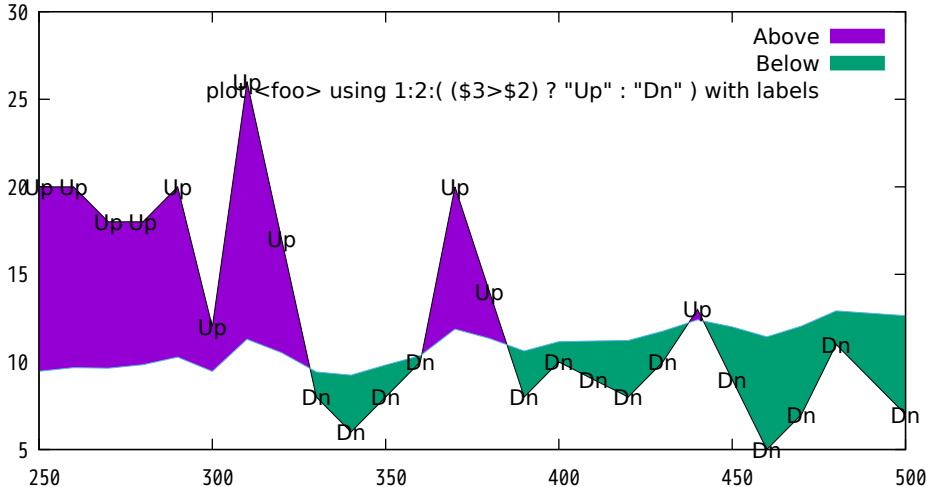

# String-valued functions to generate datafile names

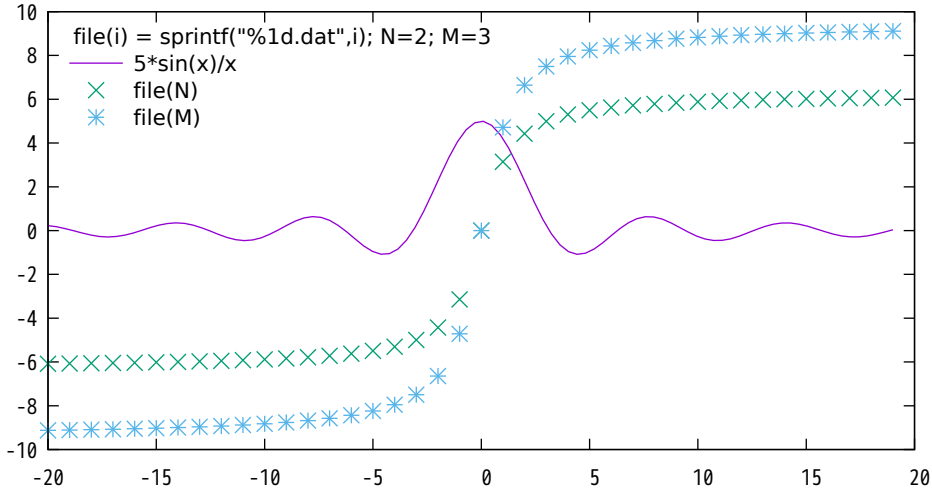

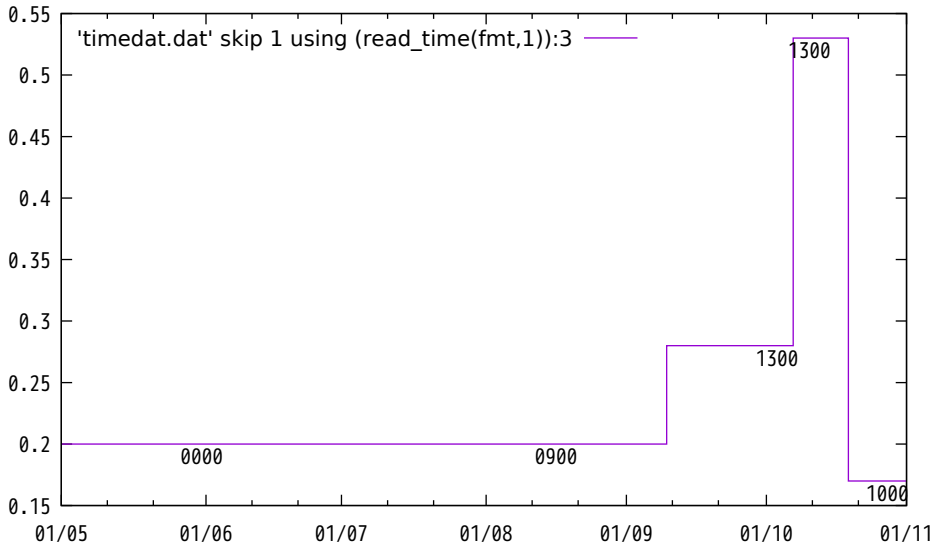

Demonstrate use of assignment and serial evaluation operators to accumulate statistics as successive data lines are read in

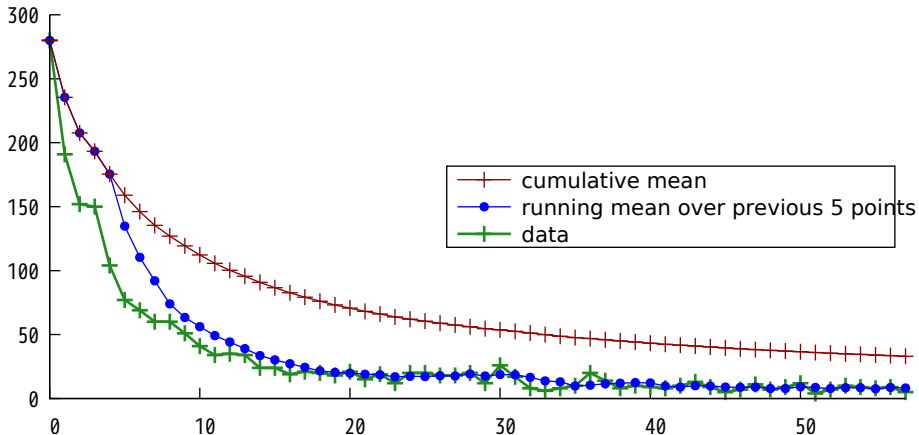

plot with variable size points

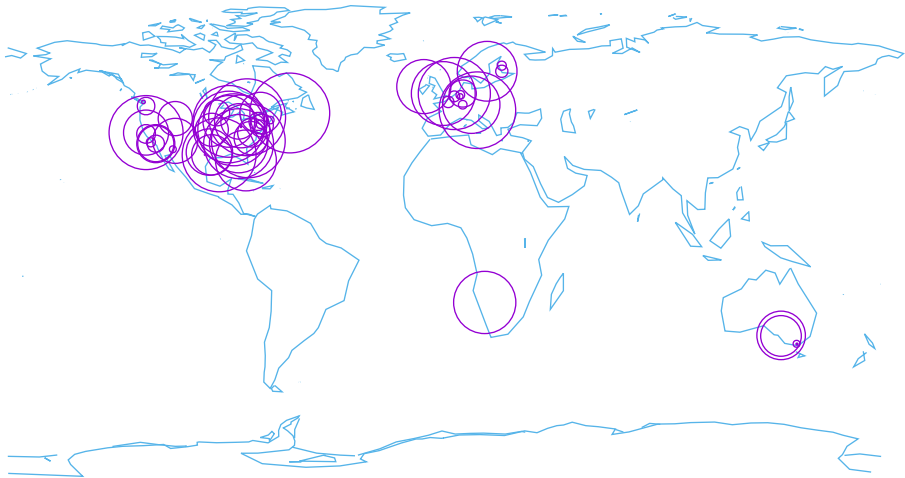

plot with variable size points  
it is possible to specify size and color separately

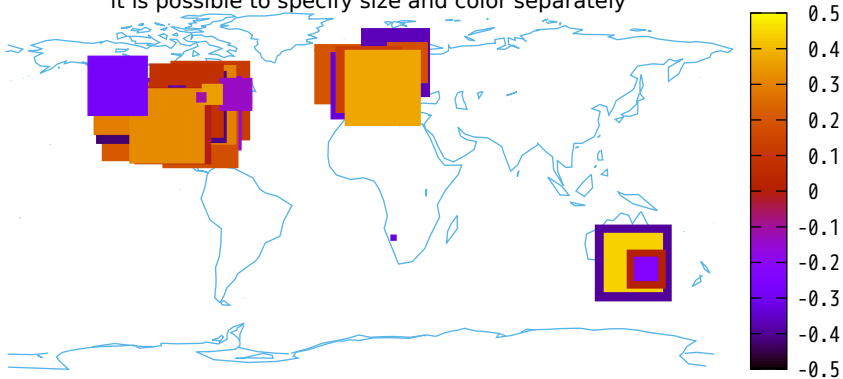

3D version using spherical coordinate system

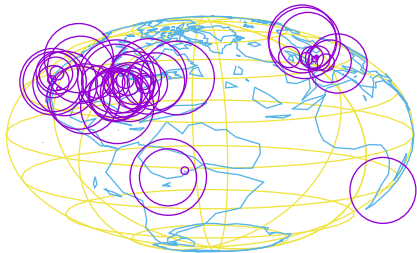

## 3D solid version through hiddenlining

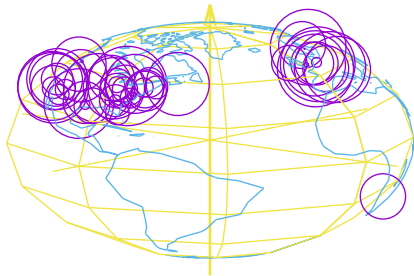



# Sources of energy production, plotted for each continent

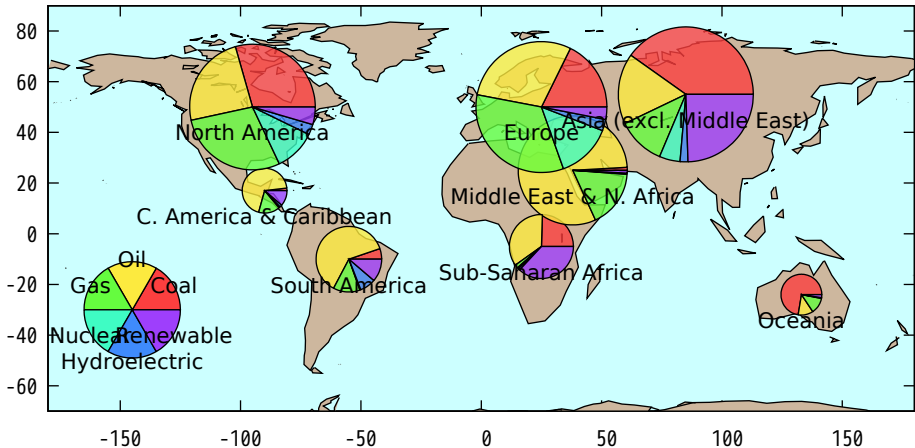

Dynamically generated pie charts

Trace of unconstrained optimization with trust-region method

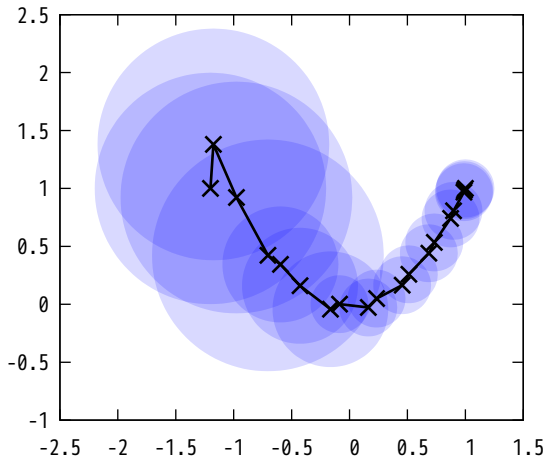

Note that overlapping transparent circles produce a darker area

## Lena's key points

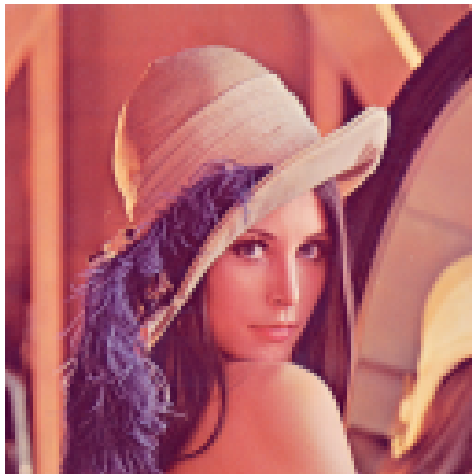

Delaunay triangulation of Hemisphere points, some empty circles in red

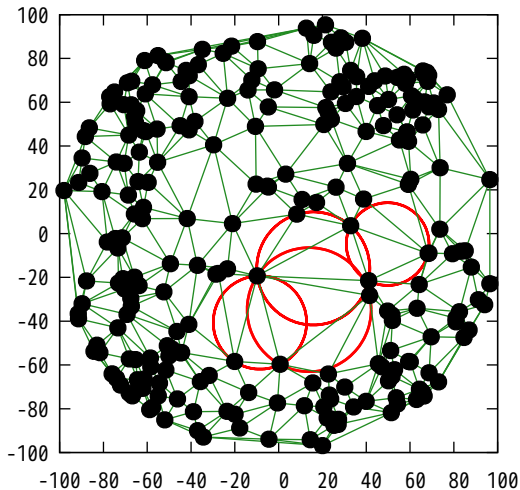

Demonstration of the 'ellipses' plotting style  
Two-column form: x y (default size)

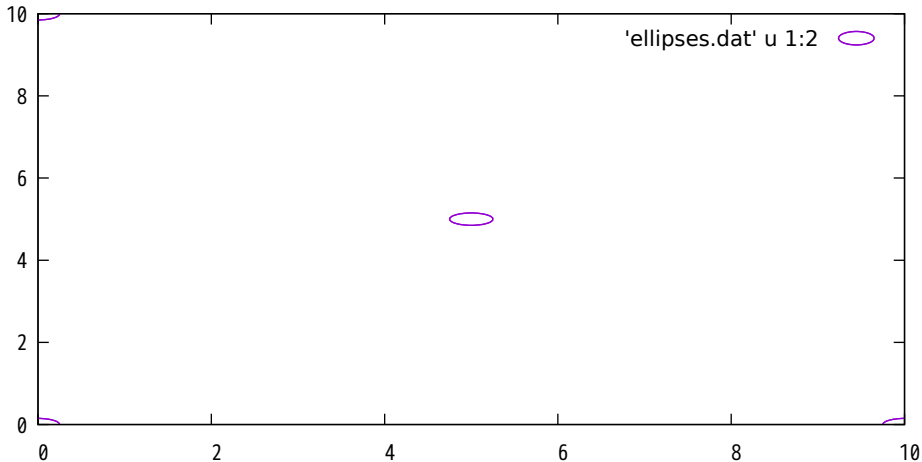

Three-column form: x y major\_diameter (minor diameter is the same)

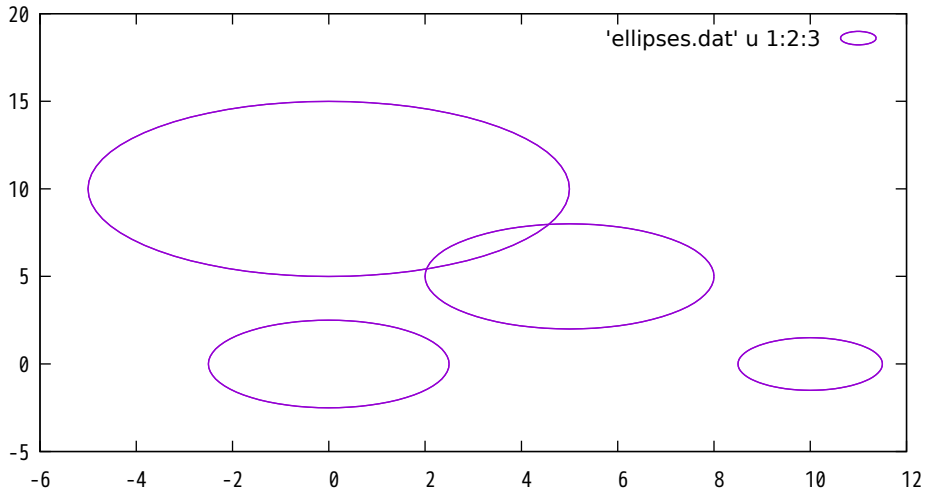

Four-column form: x y major\_diameter minor\_diameter

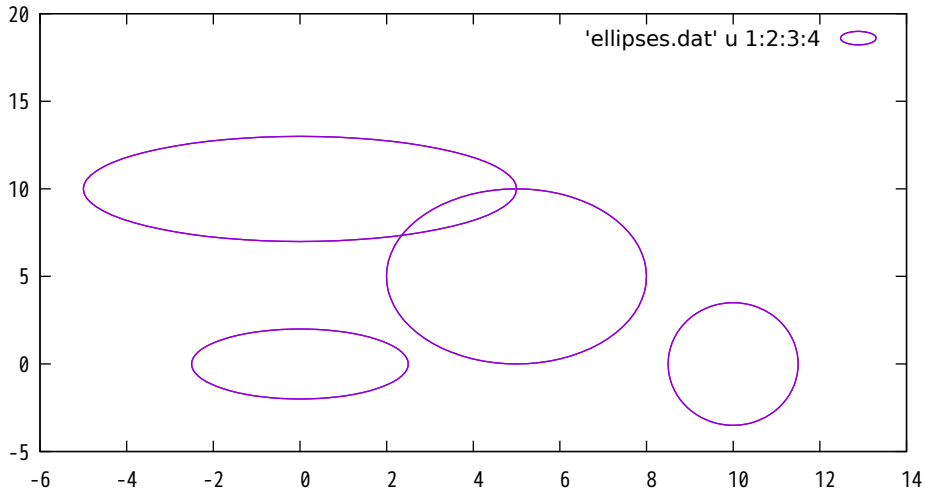

Five-column form: x y major\_diameter minor\_diameter angle

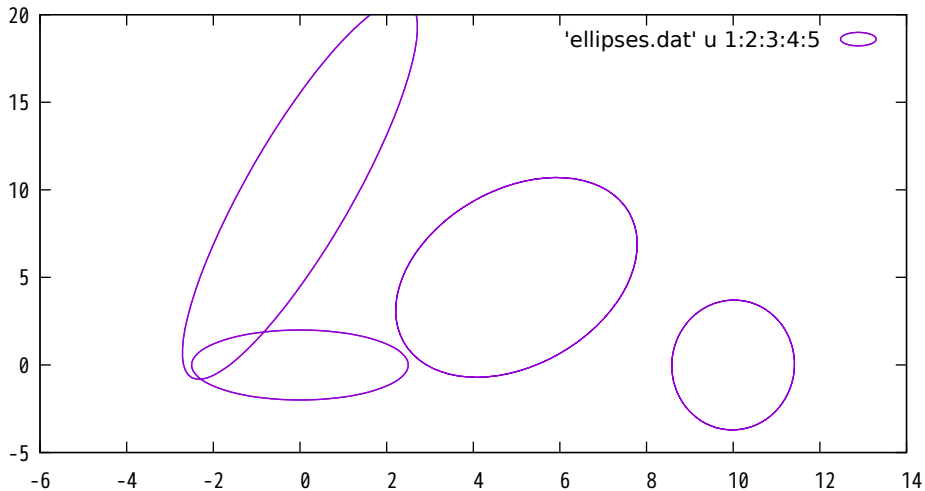



Six-column form: 6th column variable color (lc variable)

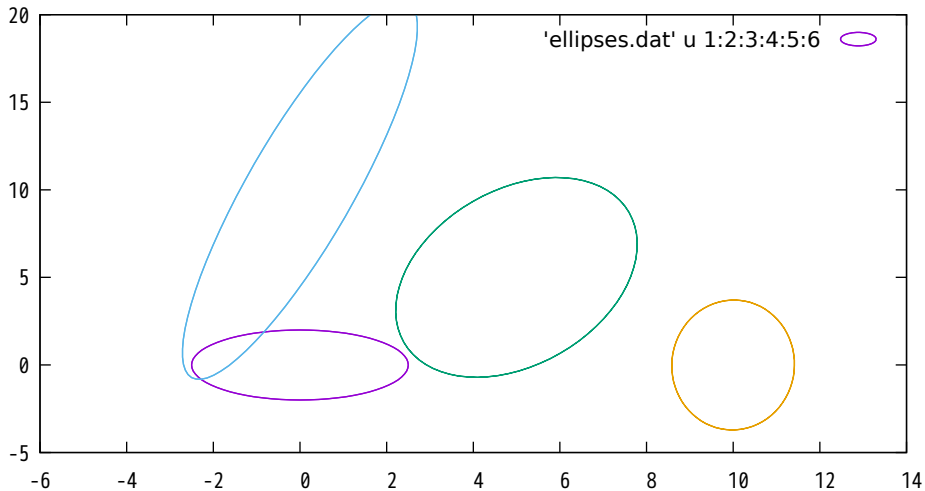

Six-column form: 6th column variable color (lc palette)

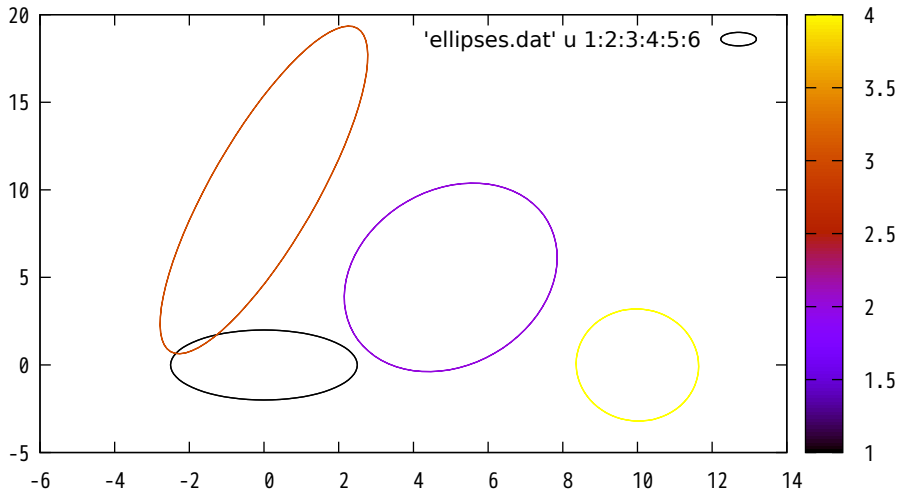

Six-column form: 6th column variable color (lc rgb variable)

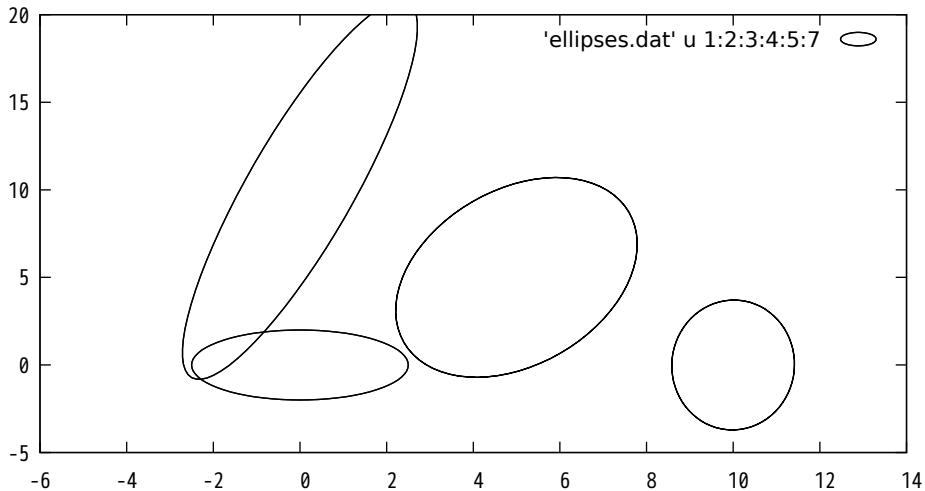

Scaling of axes: units xy

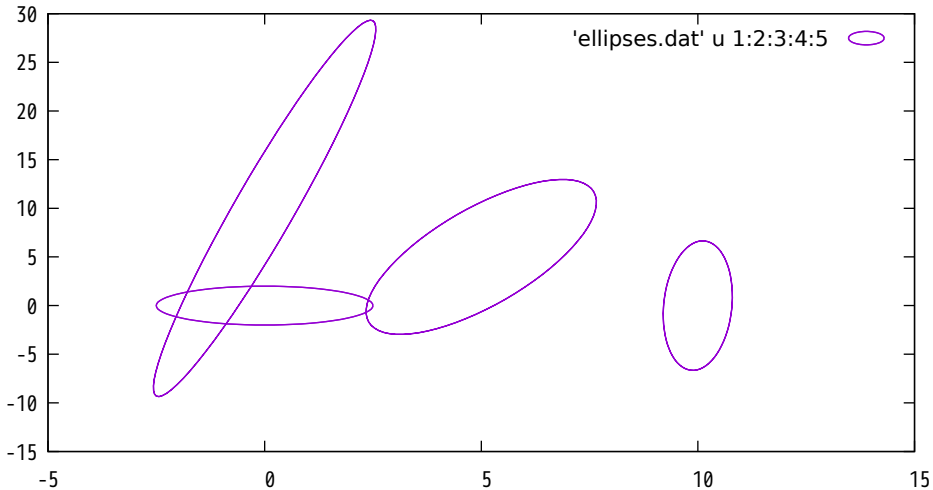

Scaling of axes: units xx

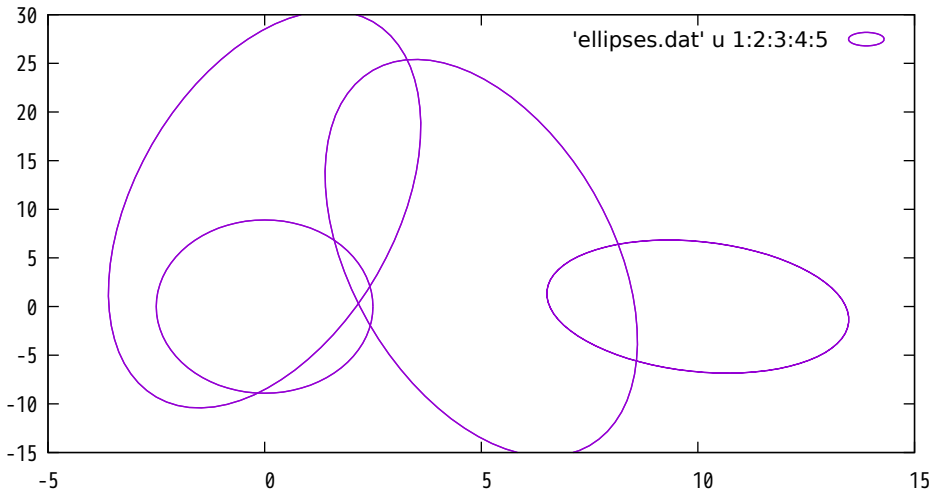

Scaling of axes: units yy

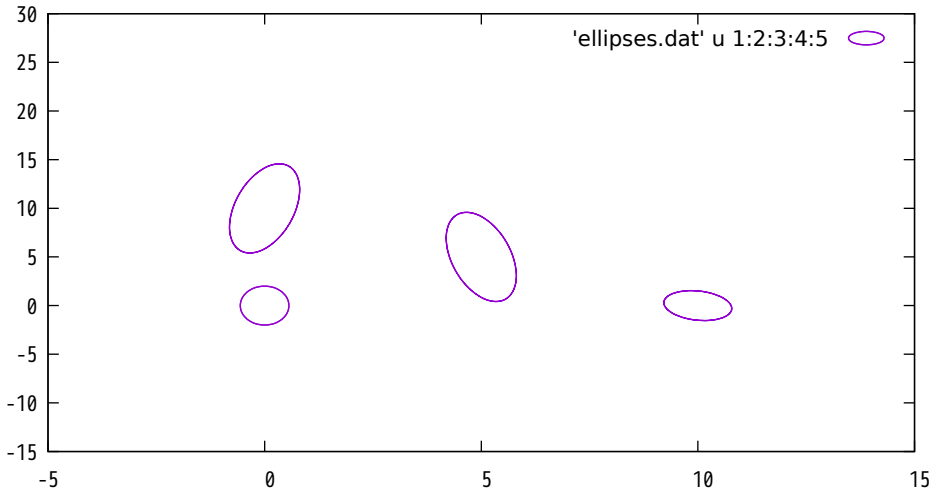

Now see all three together

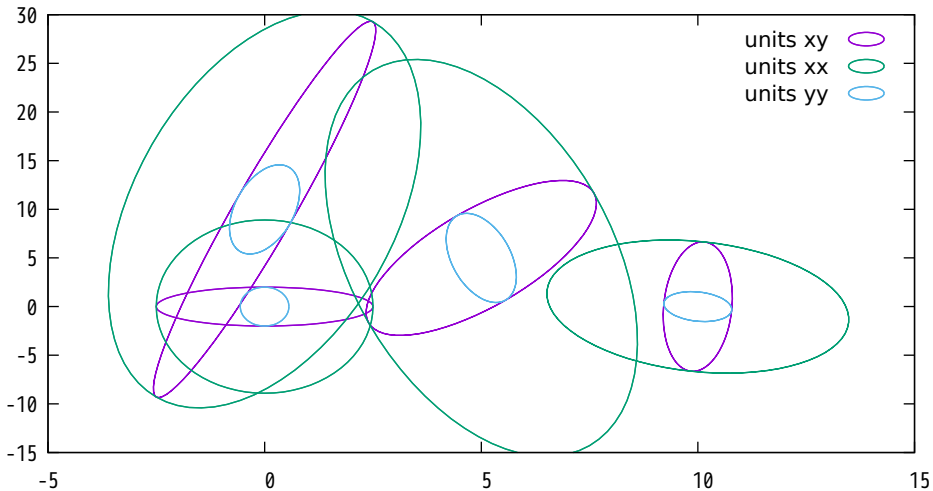

Key (ins vert left top)

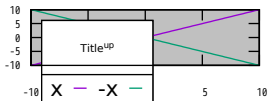

Key (ins vert center left)

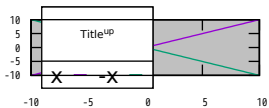

Key (ins vert bot left)

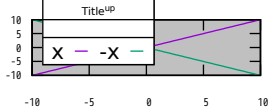

Key (ins vert center top)

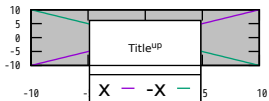

Key (inside vertical center)

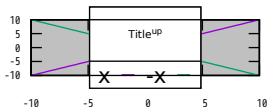

Key (ins vert bot center)

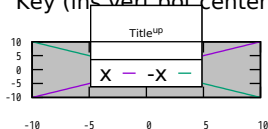

Key (ins vert right top)

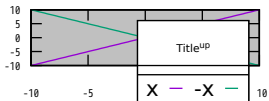

Key (ins vert cent right)

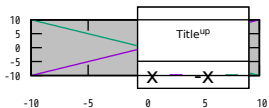

Key (ins vert bot right)

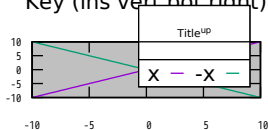



Key (ins horiz left top)

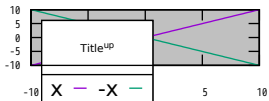

Key (ins horiz center left)

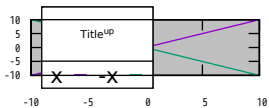

Key (ins horiz bot left)

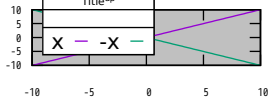

Key (ins horiz center top)

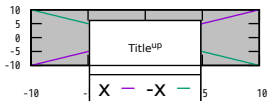

Key (inside horizontal center)

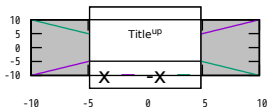

Key (ins horiz bot center)

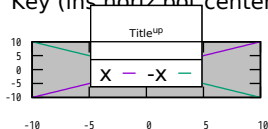

Key (ins horiz right top)

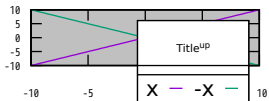

Key (ins horiz cent right)

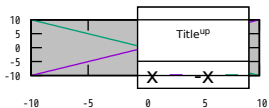

Key (ins horiz bot right)



Key (out vert left top)

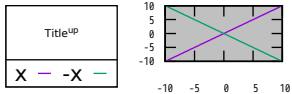

Key (out vert center left)

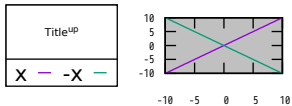

Key (out vert bot le

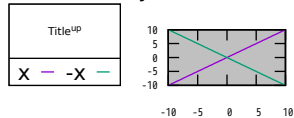

Key (ou ter top)

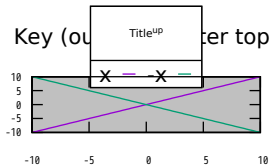

Key (outside vertical center)

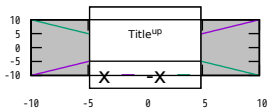

Key (out vert bot center)

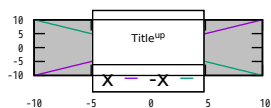

Key (out vert right top)

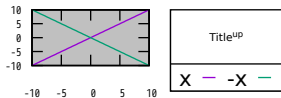

Key (out vert cent right)

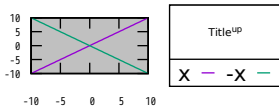

Key (out vert bot right)

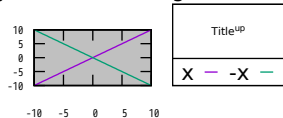

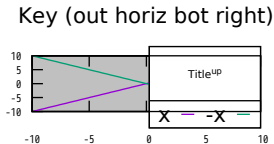
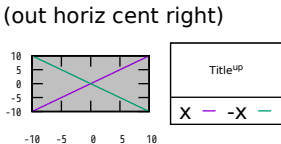
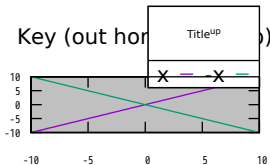
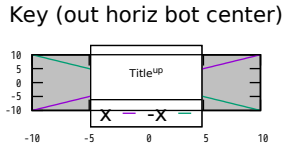
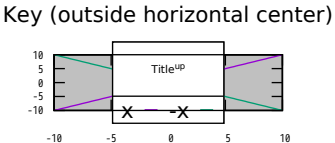
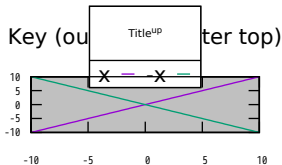
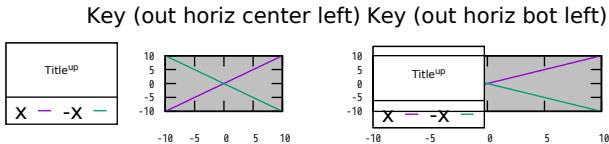
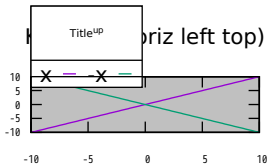

Key (<manual> vert left top)

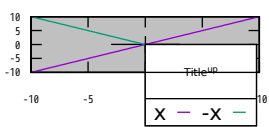

Key (<manual> vert center left)

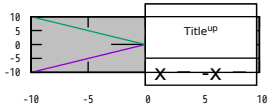

Key (<manual> left)

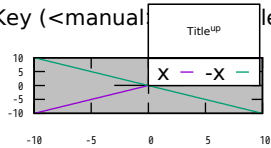

Key (<manual> vert center top)

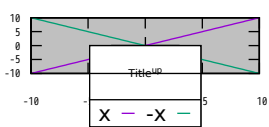

Key (<manual> vertical center)

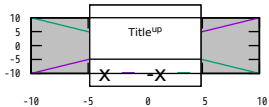

Key (<manual> bot center)

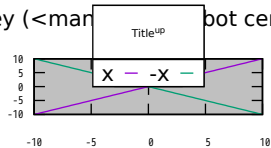

Key (<manual> vert right top)

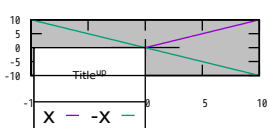

Key (<manual> vert cent right)

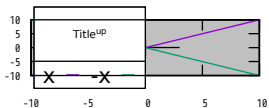

Key (<manual> vert bot right)

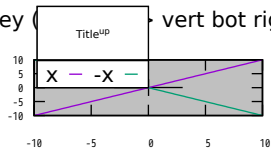



## Illustrate use of a custom key area

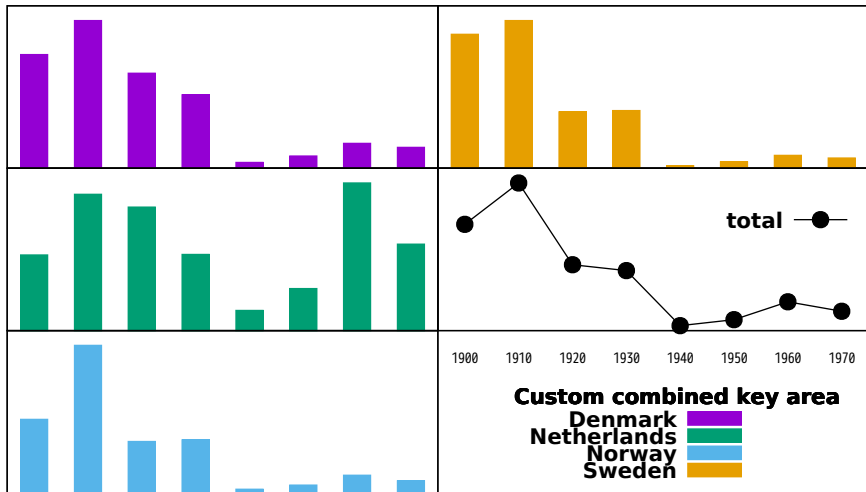

Position plot titles at the end of the corresponding curve  
rather than in a separate key

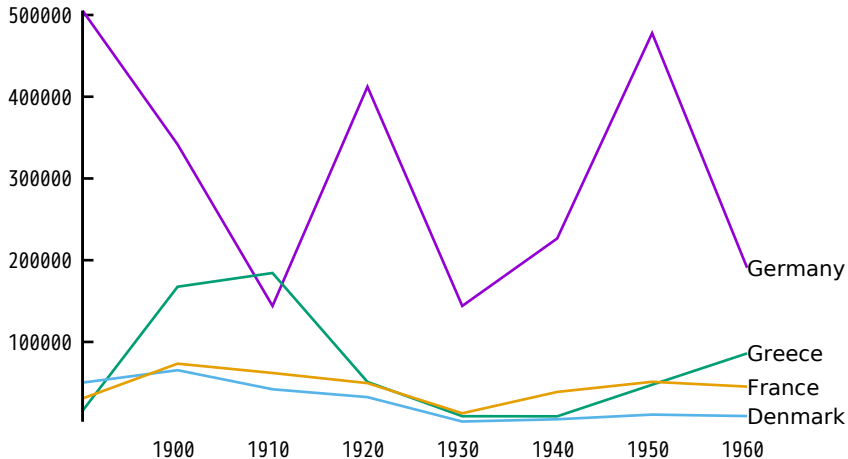

Test/demo of new feature 'grid walls'

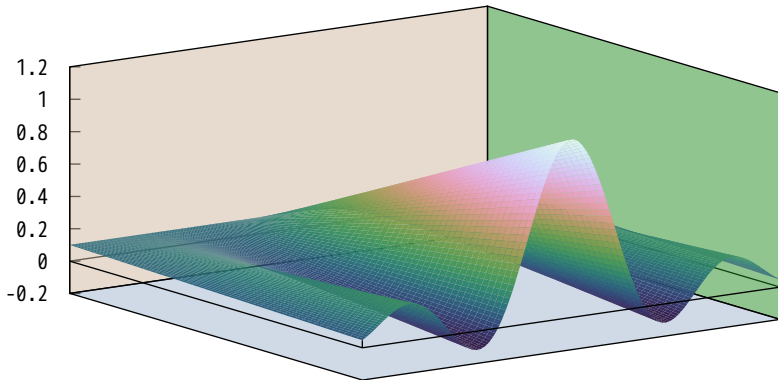



# 3D Boxes

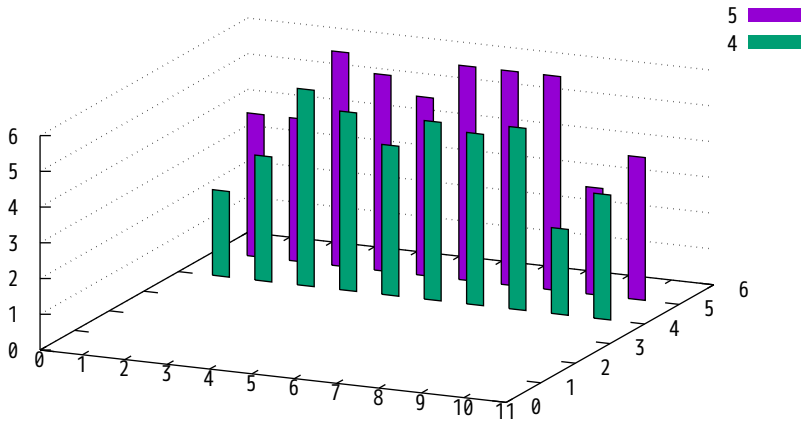

Ic variable (from column 1)

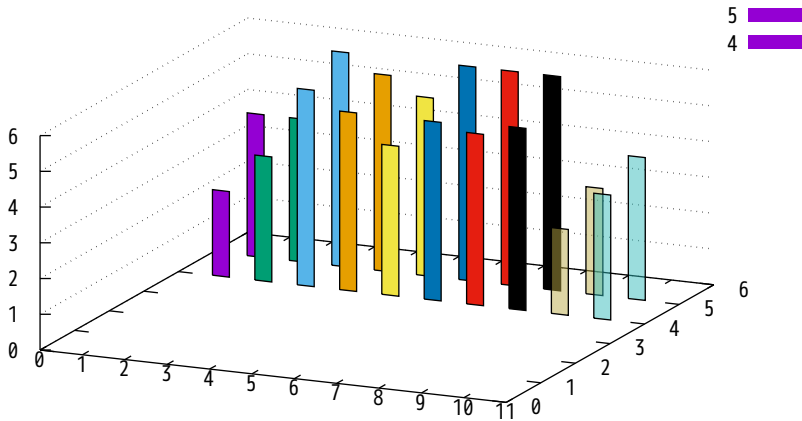

Ic rgb variable

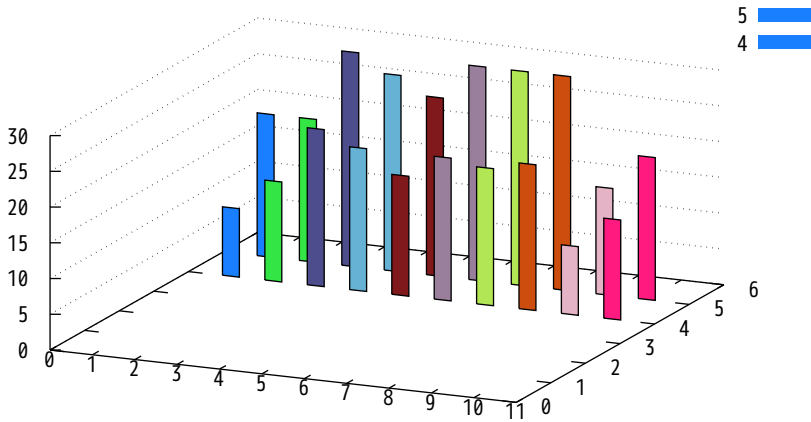

transparent boxes with imperfect depth sorting

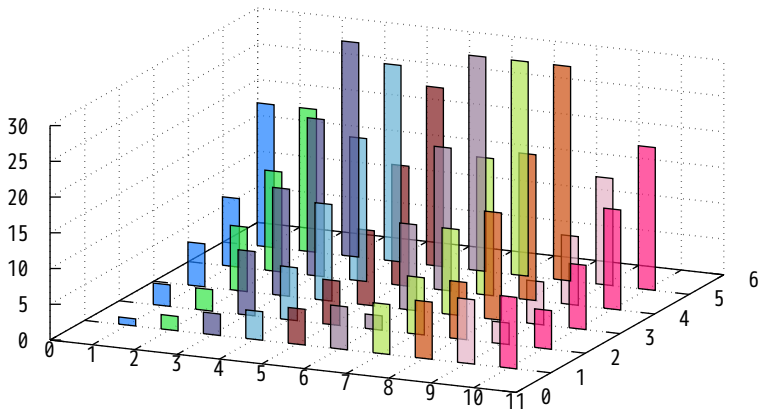

give the boxes a 3D depth and correct depth sorting

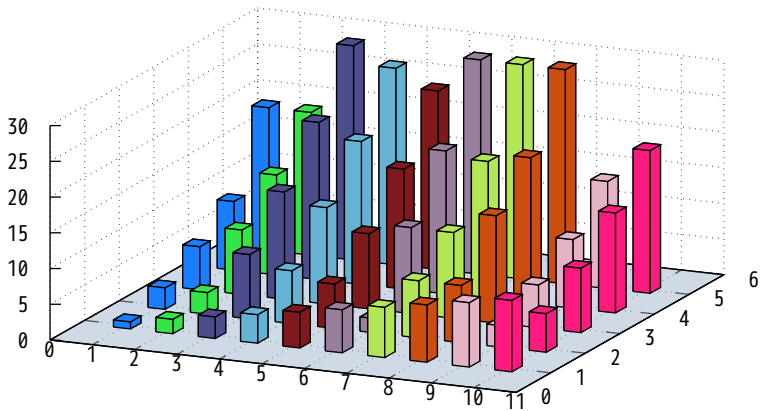

# Full treatment: 3D boxes with pm3d depth sorting and lighting

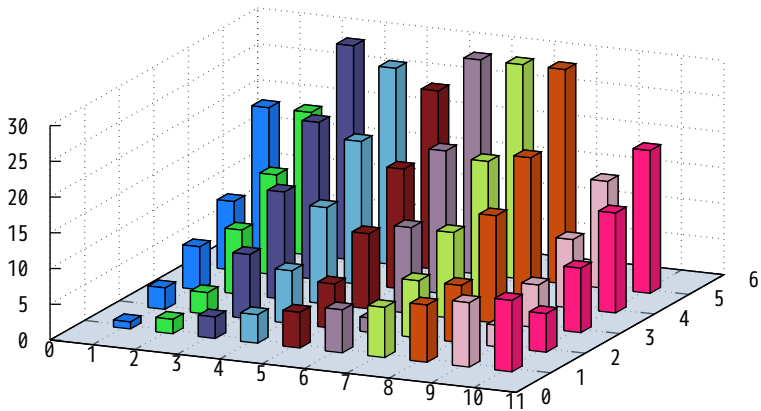

## Demonstration of different border settings

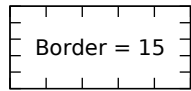
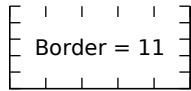
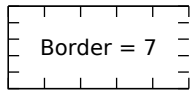
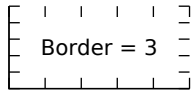
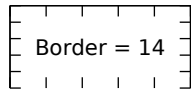
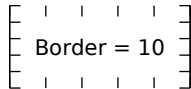
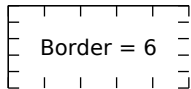
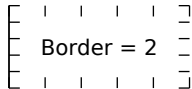
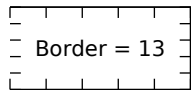
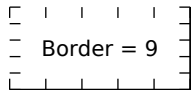
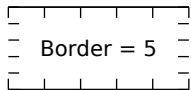
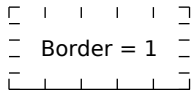
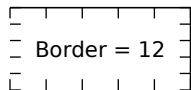
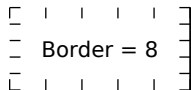
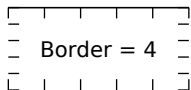
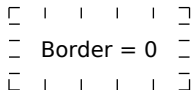

Demo of placing multiple plots (2D and 3D)  
with explicit alignment of plot borders

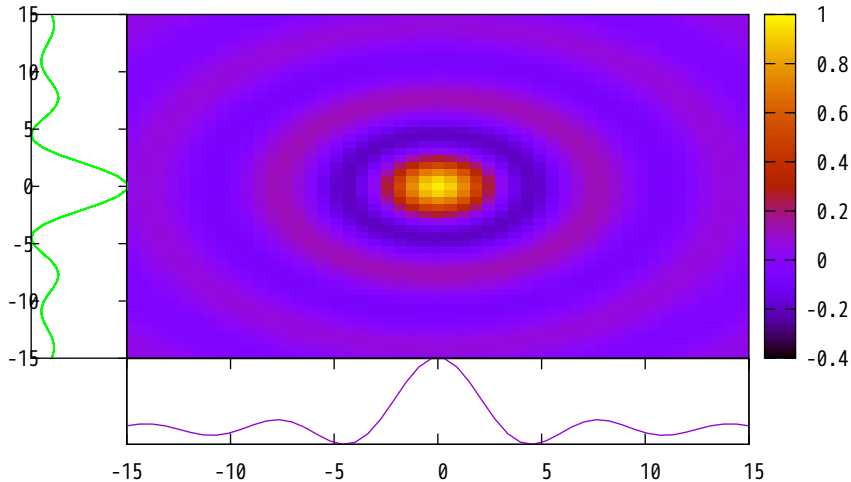



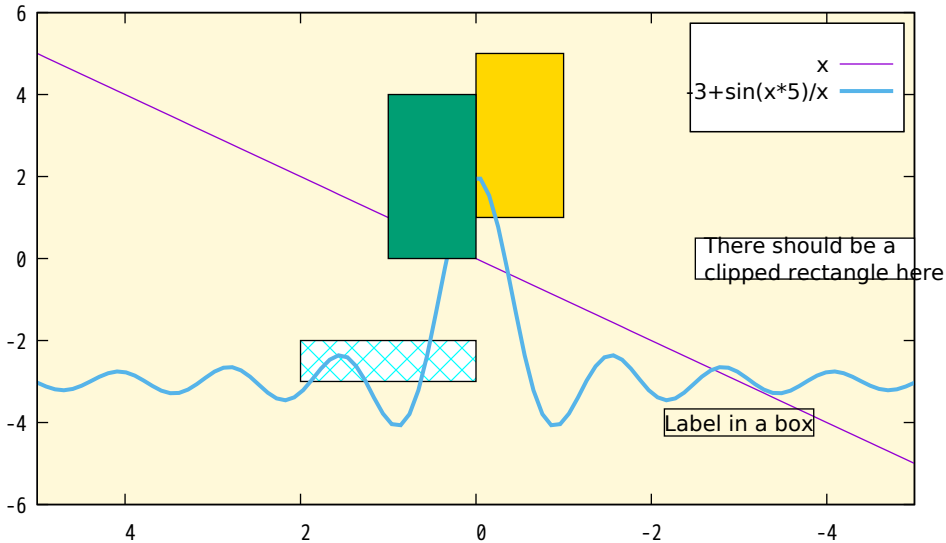

# Convex November 1-7 1989

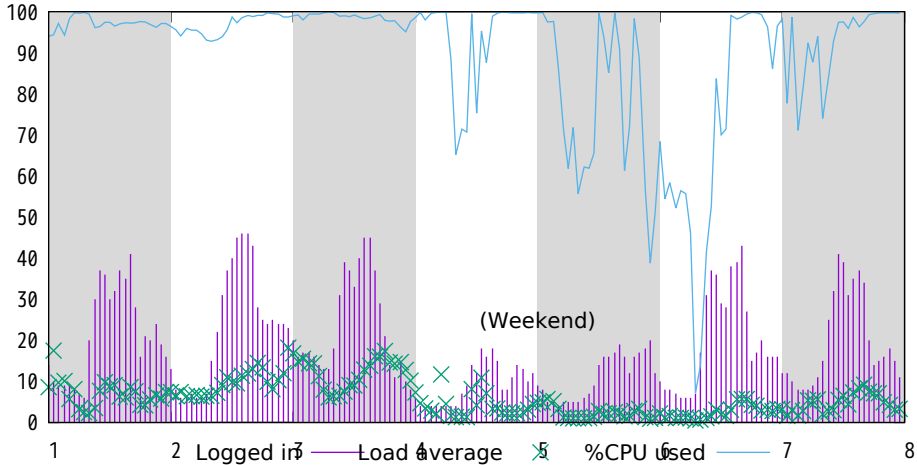

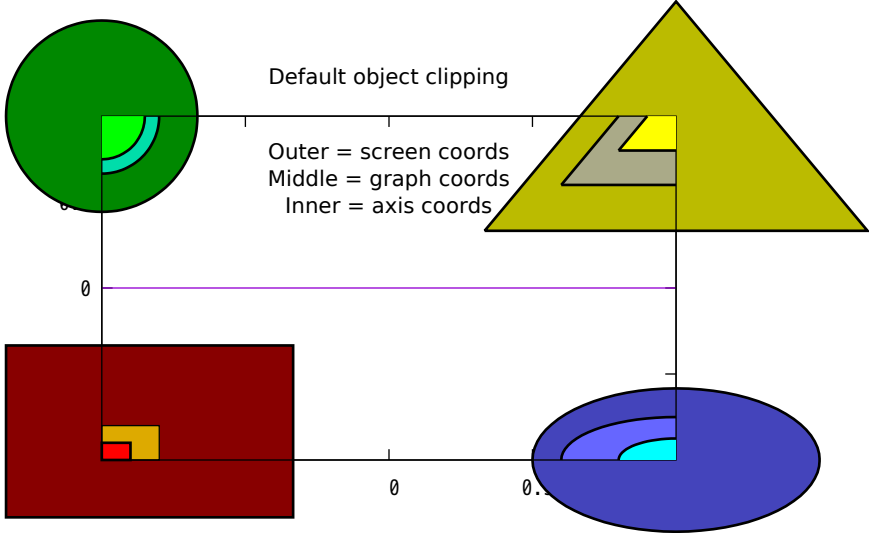

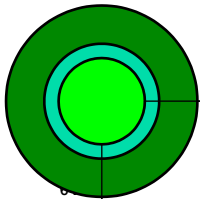

Object property 'noclip'

Outer = screen coords  
Middle = graph coords  
Inner = axis coords

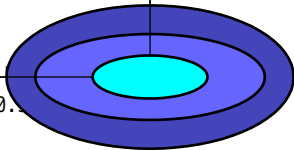
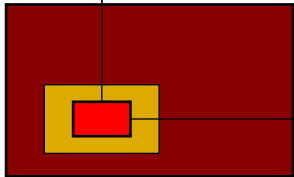
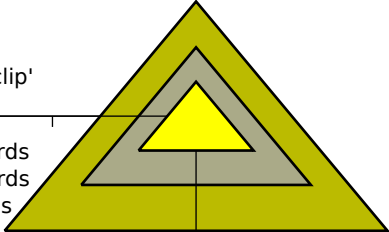

0

0

0.1

Clipping in 3D projection ('set view map')

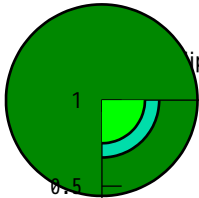

Outer = screen coords  
Middle = graph coords  
Inner = axis coords

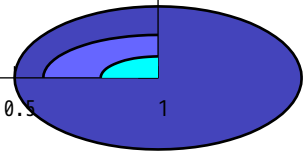
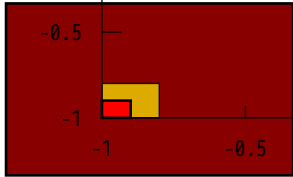
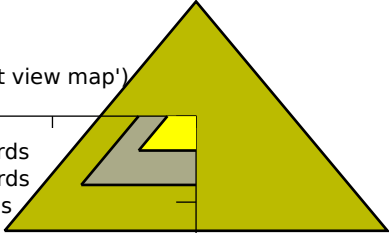

# Polynomial approximation of $\sin(x)$

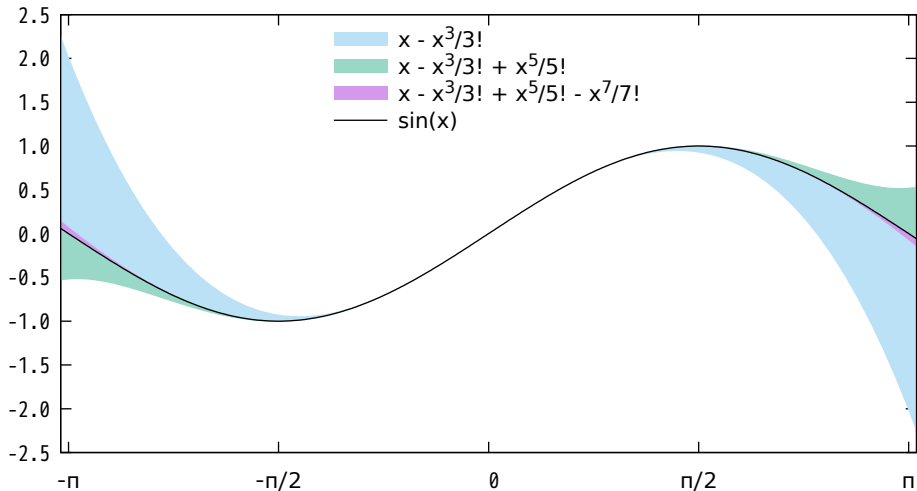

# Parallel Axis Plot

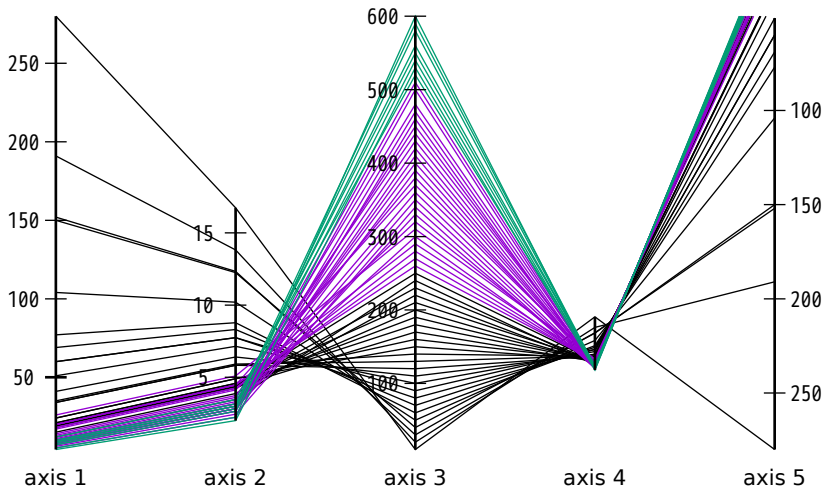

Parallel Axis Plot

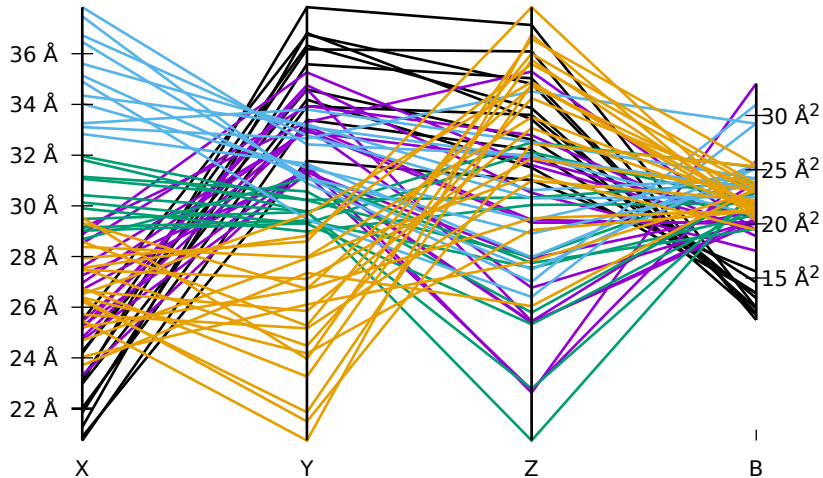



A 'broken' x axis can be defined using 'set nonlinear x'

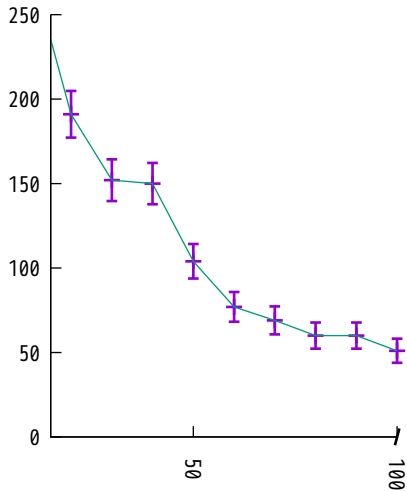

# Log-scaled axes defined using 'set log'

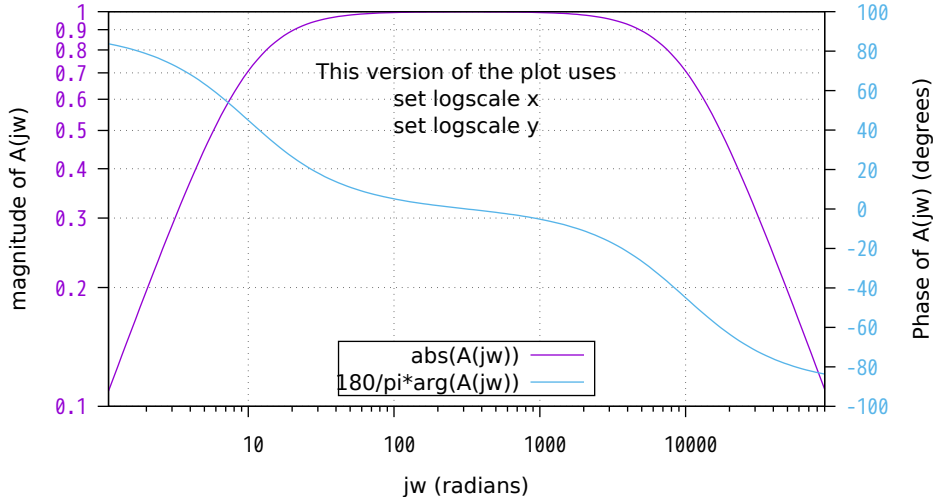

Log-scaled axes defined using 'set nonlinear'

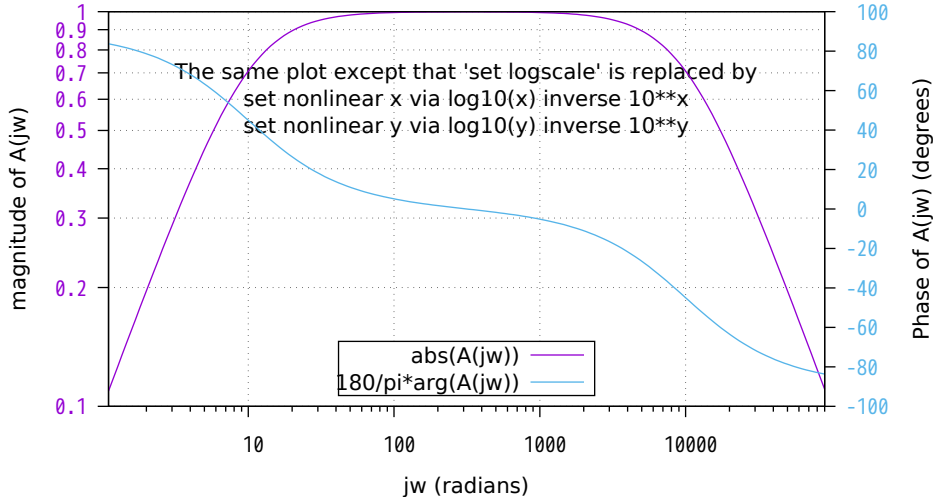

Probability axes: Scale image pixels by distance from center treated as a Z-score

Sigma = 22 pixels

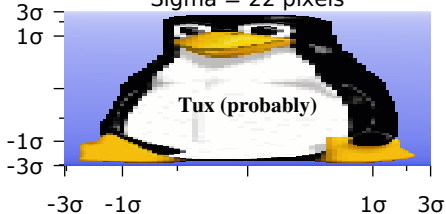

Sigma = 60 pixels

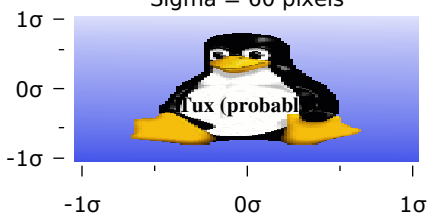

Sigma = 30 pixels

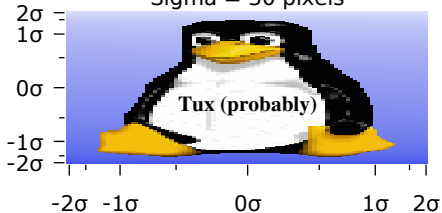

Linear Scale



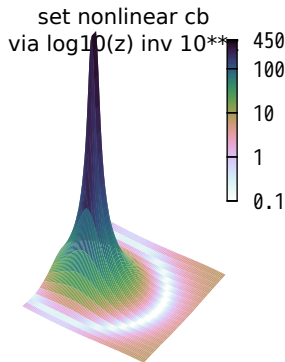
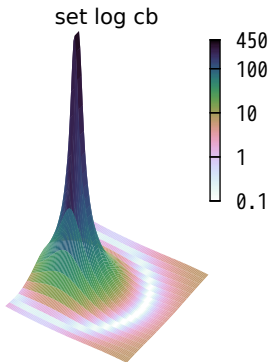
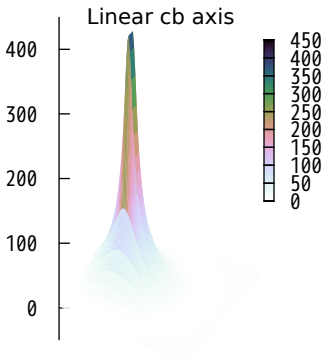

# Rosenbrock Function

Rosenbrock(x,y)

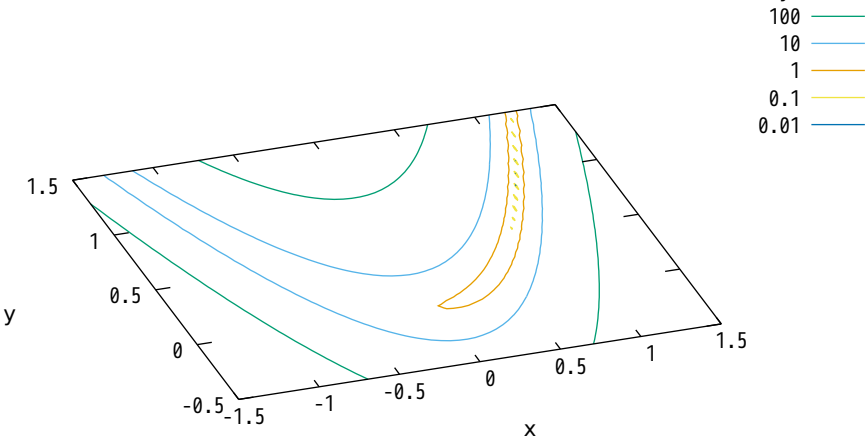

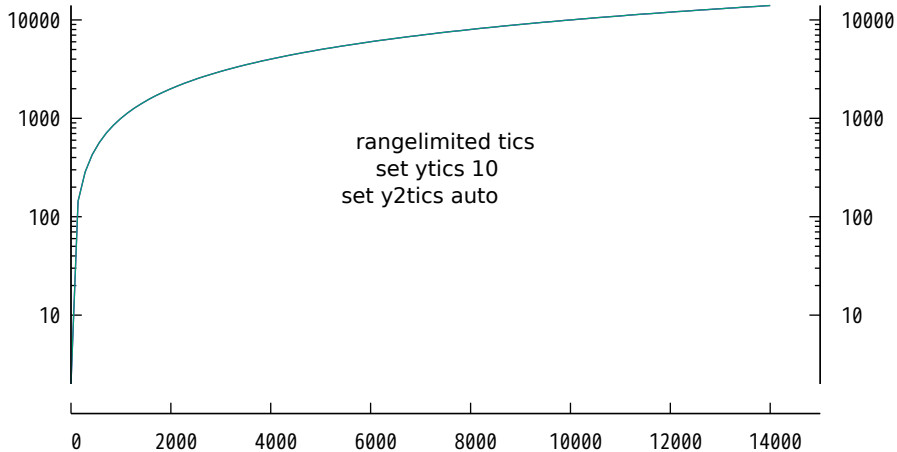

## Solid filled curves

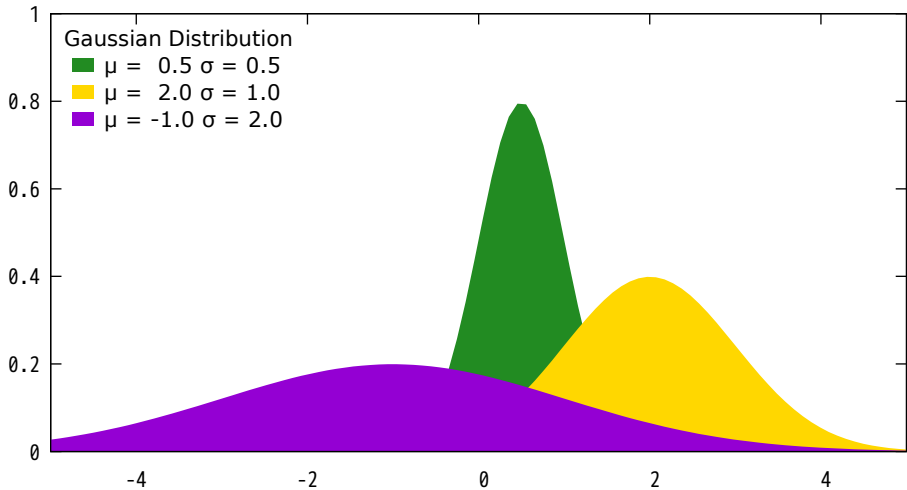



# Transparent filled curves

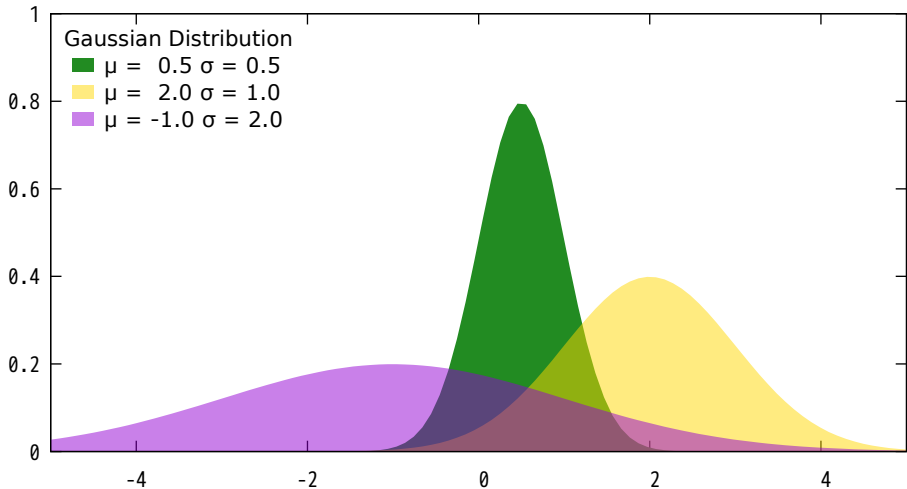

# Pattern-filled curves

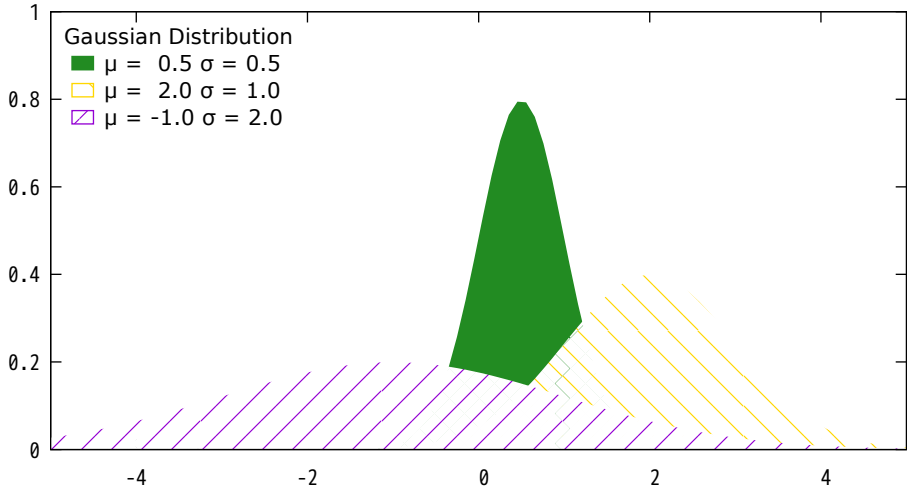

# Transparent pattern-filled curves

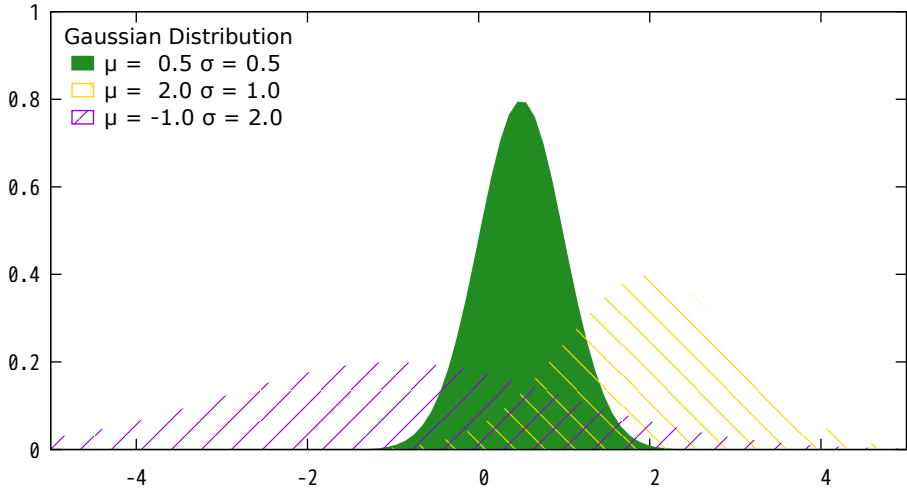

# Interlocking Tori - PM3D surface with depth sorting and transparency

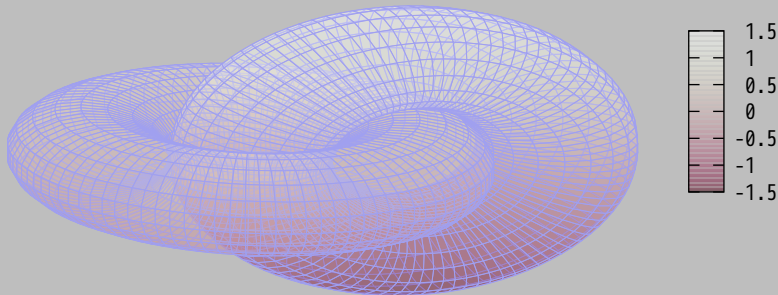

# Kuen's Surface

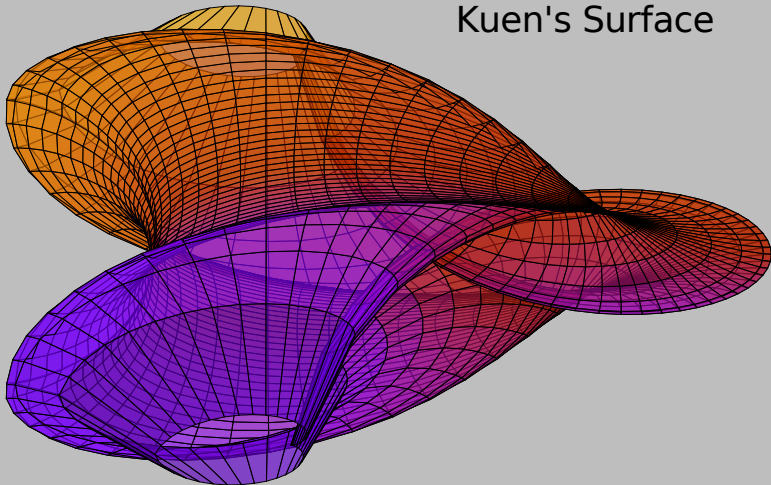

pm3d lighting model with specular highlighting

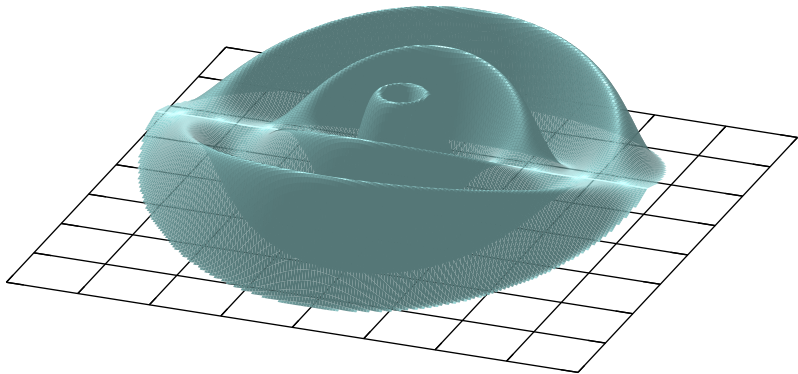

# PM3D surfaces with specular highlighting

